

Win a \$1500  
Tandy 100 computer

BRITAIN'S PERSONAL COMPUTER MAGAZINE

# BITS & BYTES

April 1985: \$2.00

## Telecomputing — Report on Videotex, modems, bulletin boards

The Vixen — has Osborne outfoxed them?  
New Apricots — as juicy as they look?  
Sperry PC — too late for the dance?  
Open Access reviewed

Columns for eight computers



# The Amstrad arrives!

# Before you compare our new computer system with any other, double the price.

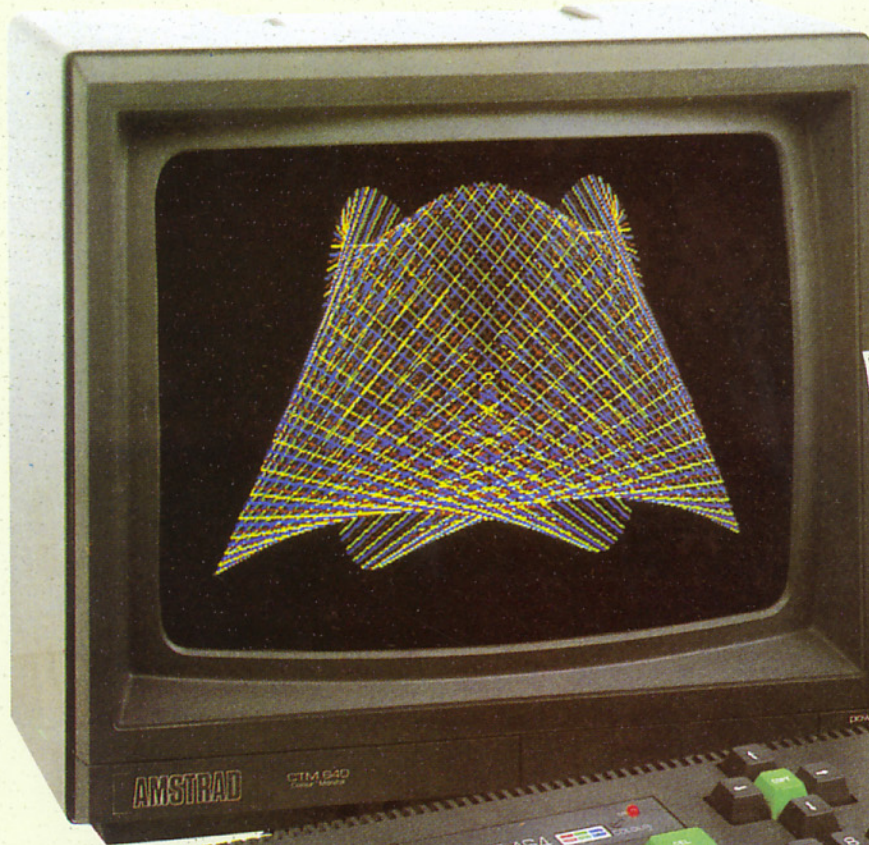

With Green Screen Monitor

**ONLY \$995**

With Colour Monitor

**ONLY \$1395**

**CPC 464**  
complete  
with  
monitor  
and  
datacorder



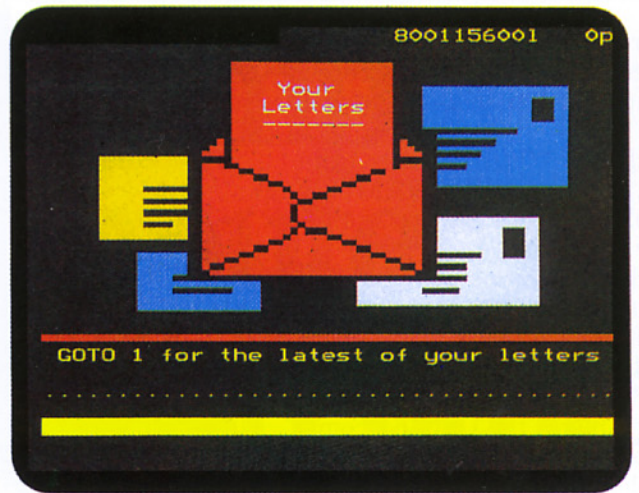

# Microcomputer Videotex is Coming!

and adding all these enhancements to your computer ...

- ★ Instant electronic information
- ★ Telesoftware
- ★ Electronic Mail
- ★ Micro to Micro Communications and more ...

The Bits & Bytes videotex service is now in its preparation stages.

But we need an indication of your interest and wants so we can plan ahead.

If you are interested in an electronic magazine including all the above features then please complete and return the no obligation coupon below and you will be placed on our preferential mailing list for further information.

Send to:

**Microcomputer Videotex Service**  
 Bits & Bytes  
 P.O. Box 9870  
 Auckland

**Yes!** I am interested in subscribing to your planned microcomputer videotex service.

Please send me further information as soon as possible.

Name .....

Address .....

Name and Model of computer you own/use .....

Any suggestions for the service .....

## FEATURES

### Telecommunications

The telecommunications revolution is about to hit New Zealand, and we're helping prepare you. Nobilangelo Ceramalus defines videotex. Selwyn Arrow gets to the core of modems. Selwyn Arrow taps into the bulletin boards.

22  
24  
28

### Hardware reviews

Arnold — more formally known as the Amstrad CPC464 — wants 25% of the computer market. Peter Ensor assesses his chances of achieving that goal. The Vixen, the latest portable computer from Osborne, has been born after a two-year gestation. Selwyn Arrow reports. Sperry claims its new PC will run any software written for the IBM PC and support any hardware supported by the IBM. Peter Brown tests this recipe. The new Apricot F1 is something of an indifferent fruit, according to reviewer John Slane. He delivers his judgement.

32  
36  
40  
42

### Software Review

John Vargo completes his assessment of four integrated packages . . . this time Open Access. He concludes with a comparison of Vision, Symphony, Framework and Open Access.

49

### People

John MacGibbon concludes his exclusive and absorbing interview with that "living piece of history", Apple founder Steve Wozniak.

46

### Word processors

A Wellington neurologist is developing a Chinese word processor on his BBC . . . a task which has proved beyond many others over the past 15 years. Pat Churchill talks to David Fung.

54

### Education

Peter Revell has swapped the classroom for the commercial computer world in the hope of combining the best of both worlds. He talks of his move and his hopes.

60

## COLUMNS

Apple: Alex & Fred Wong get to work with Scribe thermal transfer printer from Apple.  
Atari: Why the shortage of Atari products, asks Michael Fletcher. And he reviews a thriller on ice.  
BBC: Pip Forer explores authoring language and Acornetti.  
Bernard Gunn looks over a beta-base database manager.  
Commodore 64: Paul Crooks gives another view of Commodore's marketing strategy with the C16 and Plus 4.  
Sega: Dick Williams details a program useful for business.  
Spectrum: Gary Parker luxuriates in the joys of Tasword Two word processing and the power of C language.  
Tandy/System 80: Gordon Findlay relates a tale of DOS and notes some new Tandy machines.  
ZX-81: Find your way through Minotaur's Maze.

70  
81  
73  
75  
67  
65  
76  
80  
64

## REGULARS

|                  |    |               |                         |
|------------------|----|---------------|-------------------------|
| Advertiser index | 92 | Glossary      | 85                      |
| Book Club        | 10 | Micro moments | 4                       |
| Books            | 82 | Micro news    | 6, 8, 9, 14, 16, 18, 20 |
| Classified advts | 92 | User groups   | 84                      |



**Apricot F1 . . . . . 42**



**Amstrad CPC464 . . . . . 32**

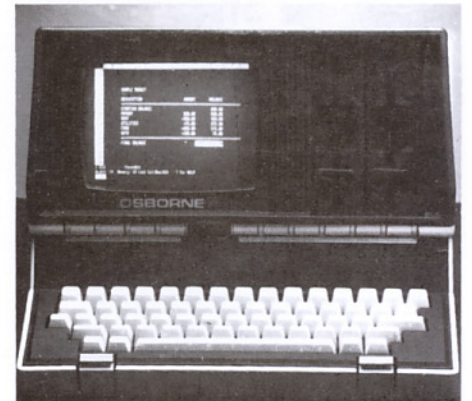

**Osborne Vixen . . . . . 36**



**Sperry PC . . . . . 40**

**BITS & BYTES** is published monthly, except January, by Bits & Bytes, Ltd.

### Advertising and Editorial

Top floor, Daytone House, 53 Davis Cres, P.O. Box 9870, Newmarket, Auckland. Telephone 549-028, 549-677.

### Subscriptions, Production and Book Club

First floor, Oxford Court, 222 Oxford Terrace, P.O. Box 827, Christchurch. Telephone 66-566.

### Management

**Managing Editor** — Paul Crooks  
**Editor** — Gale Ellis  
**Production Manager** — Dion Crooks

### Advertising Representatives

**Auckland** — Paul O'Donoghue, P.O. Box 9870, Telephone 549-028.  
**Wellington** — Marc Heymann, P.O. Box 27-205, Telephone 844-985.  
**Christchurch** — Jocelyn Howard, P.O. Box 827, Telephone 66-566.

### Editorial Representatives

**Wellington** — Pat Churchill, 5 Lucknow Terrace, Khandallah. Telephone 797-193.  
**Christchurch** — Dion Crooks. Telephone 66-566

### Merchandise

Book club and software manager: Dion Crooks. Telephone 66-566.

### Subscription

**Subscription rate:** \$16 a year (11 issues) adults and \$14 a year for school pupils, subscriptions being from the issue of *Bits & Bytes* after the subscription is received.

#### Overseas subscriptions:

Surface mail — \$27 a year.  
Airmail — Australia and South Pacific, \$49 a year; North America and Asia, \$76 a year; Europe, South America, the Middle East, \$98 a year.

**Subscription addresses:** When sending in subscriptions please include postal zones for the cities. If your label is incorrectly addressed please send it to us with the correction marked.

### Distribution

**Inquiries:** Bookshops — Gordon and Gotch, Ltd.  
Computer stores — direct to the publishers.

### Disclaimers

**Opinions:** The views of reviewers and other contributors are not necessarily shared by the publishers.

**Copyright:** All articles and programs printed in this magazine are copyright. They should not be sold or passed on to non-subscribers in any form: printed, or in tape or disk format.

**Liability:** Although material used in *Bits & Bytes* is checked for accuracy, no liability can be assumed for any losses due to the use of any material in this magazine.

### Production

**Production Manager:** Dion Crooks.  
**Assistants:** Roger Browning, Graeme Patterson.  
**Cover and graphics:** Sally Williams.  
**Typesetting:** Focal Point.  
**Printed:** in Dunedin by Allied Press.

## New-look Bits & Bytes

Welcome to our new-look *Bits & Bytes* magazine. This month, *Bits & Bytes* has more colour and more pages.

But most importantly in ensuing months we will provide more reading aimed specifically at computer users . . . more reading on what you can do with your computer as our surveys show more *Bits & Bytes* readers own or use a computer.

This will include more in-depth columns for the biggest selling computer brands so that you can discover more about your computer.

Features, such as our telecomputing feature this month, that will show what adding peripherals and a range of software can do for your computing power.

More programs to type and try as we run regular program specials of programs submitted by you, the reader (remember we pay for programs so keep sending them in).

For those wanting to delve deeper into the workings of computers, we kick off a new advanced computing section next month with a series on machine language. Most articles in this section will start with basics to allow anyone to pick it up and follow it.

We also intend to start a help and advice column where readers can send in any queries or problems they may have and our team of writers will attempt to solve them. If you have any hints or tips you would like to pass on to others, we will include them in that section and whatsmore, pay you for them.

New computer reviews will continue to appear in *Bits & Bytes* as some readers don't own computers and a significant proportion of others are or will be looking to upgrade or add to their existing systems.

There will also be features for those interested in business applications.

The majority of these articles will continue to be written by New Zealanders and relevant to New Zealand conditions (and contain New Zealand prices/).

We welcome reader feedback on further developments and we hope you will continue to support us in 1985 and beyond.

## COBOL breakthrough

A US application breakthrough, which brings the capabilities of mainframe COBOL to microcomputers, has just been released in New Zealand.

Developed by the Microsoft Corporation, this software enables microcomputers to be used in the development of COBOL applications for mainframes, while COBOL

applications used on mainframe systems can be switched to microcomputers.

In effect, this compatibility will allow large organisations using both mainframe and microcomputers to use a common language for all their development.

It also means data processing departments will be able to use microcomputers instead of minis or mainframes for development systems.

## MICRO MOMENTS

BY MATT KILLIP

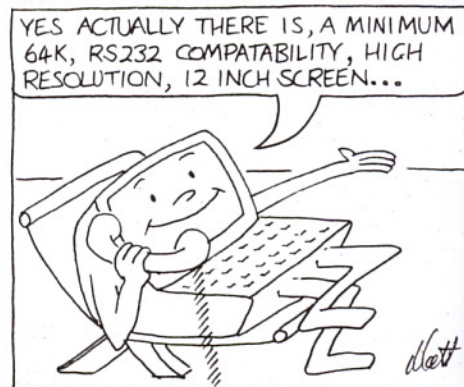

# If you've the taste for success, pick Apricot.

You're already in business and it's growing steadily.

You've already tasted the fruits of success and obviously want to continue that way.

Your company is expertly managed, but you're just reaching that critical stage when you need to consider getting a computer, or updating your present system.

What you need is a computer to look after your interests, as your company expands over the years. A computer that can tackle any business activity. A computer that will not date this year, next year, or the year after that. A computer that can also offer you the largest range of business software available.

The answer is an Apricot.

Following a fine British tradition, Applied Computer Techniques offer some of the finest technology available in the world.

So if you've the taste for success, pick Apricot and watch your business grow.

 **apricot**  
Simply Superior.



Apricot F1

The F1 has been specifically designed for the first-time business user—the person whose first computer investment must represent a genuine business machine. With features including a standard 256k of RAM (expandable to 768k), double-sided 3.5" disk drive, cordless infra-red keyboard and optional mouse, and colour electronics enabling the F1 to display colour on a wide variety of monitors, it sets a new standard in entry-level business computing.



Extensive range of software available.



Apricot XI



Apricot Portable

**BARSON**  
computers

Distributed by Barson Computers Auckland — Melbourne — Sydney  
For your local dealer, Telephone Auckland (09) 504-049 or write P.O. Box 26-287, Epsom, N.Z.  
Manufactured in U.K. by ACT (International) Ltd.

# Tandy on ice

A Tandy Model 100 computer was tested in some of the toughest conditions in the world recently.

The computer was used by a party of New Zealand scientists studying Adelie penguins in Antarctica. Observations on the behaviour of about 80 individually marked penguins were fed into the computer at regular intervals over three months.

The picture shows Dr Lloyd Davis, leader of the field team, with the Model 100 on the ice.

Some of the penguins took a close interest in the computer and Computer Advances, one of the New Zealand distributors of the Tandy range, and *Bits & Bytes* invites readers to guess what they thought of it by putting a caption to the picture below - with a Tandy Model 100 as a prize of course.

## User courses

Computer Advances has started a series of training courses for computer users and intending users. The course is run on the company's



Auckland premises by an independent consultant and starts out with "Buying Your First Computer".

From there, the day-long courses, which have an emphasis on practical experience, take a look at spreadsheeting, word processing, MSDOS and BASIC. Each seminar costs \$120 and includes lunch, refreshments and a full set of notes.

The policy will be to keep numbers low to allow plenty of one-to-one contact. Anyone interested should contact Steve Shilam and book in as soon as possible.

## Zenith's govt. contract

A US government contract for an estimated \$US99.8 million worth of high-security personal computers - the largest contract of its kind - has been awarded to a Zenith Electronics Corporation subsidiary.

Zenith Data Systems Corporation (ZDS) is expected to supply over the next five years about 10,500 special desktop computer systems to the US Air Force, Navy and Marine Corps for use in high-security applications worldwide.

The contract calls for two versions of the Z-150 PC, one with dual 5 1/4 in floppy disk drives, one with a floppy disk drive and removable cartridge winchester disk drive. Colour and monochrome ZDS computer monitors are also included.

A year ago, the Air Force and Navy awarded Zenith a \$US29.3 million contract for dual 16 and eight-bit Z-100 desktop computers. Shipments of Z-100 computers to the Air Force and Navy have exceeded the estimated quantities of the original contract.

**Value \$1560**

# Come in from the cold

# Win a TANDY 100 computer



Just match this picture with a suitable caption. The best, most creative caption wins! All entries to:

TANDY PENGUIN COMPETITION  
Box 9870 Newmarket

All entries must be received by May 20th. The winner will be announced in *Bits & Bytes* July.

**SPONSORED BY:**

**COMPUTER ADVANCES** and **BITS... & ... BYTES...**  
NEW ZEALAND'S PERSONAL COMPUTER MAGAZINE

**Your Caption:** .....

**Name:** .....

**Address:** .....

**CONDITIONS OF ENTRY:** The contest is not open to employees or the immediate families of Computer Advances Ltd, Bits & Bytes or Wallman Communications Ltd. The Judges' decision is final and no correspondence will be entered into. All entries must be received by midnight May 20th, 1985.



# Dick Smith Electronics

## NOW THERE'S A SPECIALIST COMPUTER STORE NEAR YOU!

In every Dick Smith Electronics Store you'll find **COMPUTER CITY** - a complete range of computers, peripherals, software and accessories! Our specially trained salespeople can advise you on the computer that best suits your needs. From beginners computers to complete business systems, if you're looking for a specialist store offering total customer support, then call your nearest **COMPUTER CITY** store.

● **M24 OLIVETTI** • IBM compatible • 16 bit 8086 CPU (8MHz) • 128K RAM • One or two 360K slim floppy disk drives • RS232 & Centronics Ports • Sound circuitry • Calendar/clock • 83 key keyboard • Colour display • MS DOS Operating System • FROM \$8,298

● **M21 OLIVETTI** • The Portable Alternative • a compact M24 • includes two 360K disk drives • 128K RAM • MS DOS • RS-232 & Centronics ports • 9 in screen • DMA circuitry • High resolution graphics • Totally self contained • Cat X-5204 • FROM around \$9,500

● **CAT COMPUTER** • 6502A CPU (2 MHz) • 32K ROM containing 24K enhanced Microsoft BASIC • 64K RAM • 81 key keyboard • High resolution colour graphics • 560 x 192 pixels • Centronics ports • 4 sound channels • Cat X-7500 • FROM \$1295

● **VZ300 PERSONAL COMPUTER** Z80 (3.54 MHz) • 16K BASIC ROM • 18K expandable to 64K RAM • 45 full key stroke keyboard • Cassette interface (Baudrate 600BPS) • 32 columns x 16 lines screen • 128X64 dots (8 colours) graphics • Cat X-7500 • FROM \$349

● **AQUARIUS COLOUR COMPUTER** • Z80A Microprocessor • 2K RAM expandable to 34K • 10K ROM • Built in Microsoft BASIC • 40 column x 24 line display • 320 x 192 graphics resolution • 16 colours • 49 moving key keyboard • Cat X-6000 • FROM \$ 179

● **COMMODORE 64** • MOS 6510 CPU with extra I/O • 64K RAM • 20K ROM • Full Qwerty layout keyboard • 320 x 320 high resolution graphics • 16 colours • 3 voices-9 octaves each • Built-in BASICinterpreter • FROM \$695



Join Radio New Zealand's  
Radio Computer Club  
in association with  
Dick Smith Electronics  
Monday 7.30pm - 7.45pm 1ZM  
Tuesday 7.30pm - 7.45pm  
1ZH, 2ZM, 3ZM, 4ZB.

**RADIO**  
NEW ZEALAND

**DICK SMITH**  
**ELECTRONICS**

bankcard

VISA

Finance available to  
approved applicants  
through

AGC

PTY LTD  
NZ148ja

● Newmarket - 54 7744  
● Papatoetoe - 27 82355  
● Avondale - 88 6696  
● Auckland City - 38 9974  
● Hamilton - 39 4490  
● Christchurch - 50 405  
● Wellington - 73 9858  
● Dunedin - 74 1096  
● Mail Orders Dick Smith Electronics  
Private Bag NEWMARKET Ph: 50 4409  
POST & PACKING \$5.50

# SAMM upstages telephone

An Australian-designed computerised sales and marketing management software system will be marketed in Australia and New Zealand by Interactive Applications Ltd.

The software aims to virtually replace the telephone as the number one sales aid by improving written communications with clients and prospects.

SAMM, as the package is called, has been developed out of a philosophy that all sales and marketing should be activity oriented rather than sales or dollar oriented. It has been designed around a powerful computerbase that allows individual users to tailor information they want to capture on a client-prospect database.

The system is not fixed in any way in terms of data input or output. And while it has been developed for non-computer experts, the package has applications across a wide business and market segment including professional groups which may have difficulty in producing a complete list of client prospect names and addresses.

There is a budget and forecasting system for each salesperson (by sales volume, activity and product sales) and variance analysis is available against actual results for any selling period.

## Car package

Computer Advances has released a turnkey package for car dealers. It is well suited to smaller yards (say 15 - 40 cars) as well as large dealers requiring multi-terminal systems.

Developed by two car dealers in New Zealand, the software includes a full set of accounting software-debtors, stock control, order entry, invoicing - along with a CP/M operating system and a games series to boot!

The smaller system on the Model 4P, with two built-in floppy disk drives and a printer, retails at under \$10,000. Larger systems available on the Model 1200, which can support a multi-terminal system, will cost about twice that.

## Bible research

A Bible research program designed to run on the BBC has been developed in Kaitaia by Newtec.

The program is designed to search New Testament text looking for a match of words or phrases specified

by the user. The verse reference or the text of a verse containing a match for the words or phrases is held on output disk for later analysis by a word processor program.

Specific in its hardware requirements, Scroll operates on the BBC Model B micro with 1.2 operating system, Acorn disk filing system and dual double-sided, 80-track disk drives. It retails at \$450.

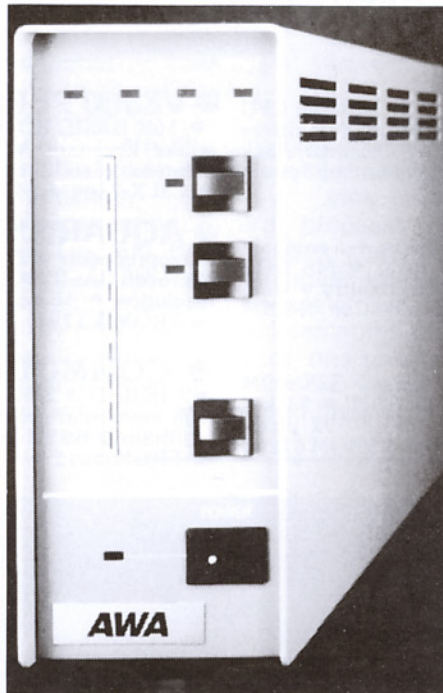

*The Mitsubishi printer-buffer*

## New printer-buffer

Up to three computers can be connected to a printer with a new printer-buffer from AWA (P.O. Box 50-248, Porirua).

The standard Mitsubishi printer-buffer, which retails for \$731 including tax, has 64K bytes of memory; other models have up to 512K-bytes (one page of writing is about 215K-bytes). It has a data input speed of 4800 bytes per second, and features a Centronics standard interface (parallel), a LED bargraph which indicates memory usage and LEDs also indicate printer buffer status.

Measuring 70mm by 174mm by 243mm, it weighs 2kg, including built-in power supply. Operation is push button, and controls include a pause switch to temporarily halt the printer, a copy switch to reprint the most recent data file and a reset switch to clear the buffer memory. It also has an internal memory check program.

If necessary, two or more printer-buffers can be connected together so that five or more computers can use the same printer.

## New Mac BASIC

Microsoft's BASIC 2.0, the enhanced version of the BASIC Interpreter for the Macintosh is now available from Interactive Applications Ltd.

Claimed by the manufacturer as the most revolutionary release of BASIC yet, it is designed to take full advantage of the Macintosh's capabilities, offering programmers a better development environment, improved interface capabilities and features that enable users to write Macintosh-style applications.

It has a 50% larger default program data area than the previous version and will retail here around \$405.

## Adventure & war games

Sofpro Software Ltd (Box 3258, Christchurch) has acquired the New Zealand agency for M.C. Lothlorien, an English software company which specialises in war and adventure games.

Initially, 10 titles for the Commodore 64, Spectrum and BBC will be produced under licence here by Sofpro.

## Technical Translation

Instruction manuals which accompany products from oriental countries do not always offer straightforward reading. While it may be understandable for simple products, a manual for a sophisticated electronic product may seriously restrict the user's understanding of how the product works.

An Auckland company experienced in overcoming this problem offers a "re-translation" service in making obscure instructions clear and understandable to the user, whether in a leaflet or a complete book.

Owner's manuals and service manuals for locally-developed products can be produced from skeletal data and the product itself, in consultation with the manufacturer.

Contact Electronic Affairs Publications. (P.O. Box 36-045, Auckland, 9. Ph. (09) 504-046).

# A 120-hour 'ironman'

Auckland-based Direction Computers spent more than 120 hours writing programs to handle the mass of data associated with plotting the progress of more than 200 contestants in the "ironman triathlon," a feature of Auckland's March fiesta celebrations.

The only official qualifying contest in the southern hemisphere for the Hawaii ironman world triathlon championship, it drew 122 contestants from outside New Zealand.

The mass of information for the event was handled by two integrated Middi Cadet computers – one for statistics and one for official timekeeping.

Each contestant was equipped with a bar code tag, allowing very accurate times to be taken by a bar code reader on completion of each section. Contestants' health and specific requirements were all recorded so that up-to-date information was available for the race doctor and his support team if assistance was needed.

Individual updates and profiles were available to the media on a screen in their area and the system allowed results to be known instantly. One terminal was devoted to marking contestants off the start/finish line and another terminal monitored contestants' numbers.

## DBMS

The Software AG Company has released a database management system for minicomputers. It will be sold and supported in New Zealand by SPL (New Zealand).

## Lotus Jazz

Jazz, an integrated business software package designed exclusively for the Macintosh 512K and the Macintosh XL (formerly Lisa 2/10) computers, combines word processing, work sheet analysis, database management, communications and business graphics functions into a single integrated package.

Users can prepare documents such as analyses, budgets, memos, proposals and reports with Jazz's five integrated functions.

Designed to be used on the Macintosh 512K computer with an external disk drive and on Macintosh XL under Macworks, Jazz will be available in New Zealand later this year.



*The Cad-Brain system*

## Cad-Brain system

Most people could use the Sord Cad-Brain system for production work within three days, according to a second-year university student who has been using it.

He says this is mainly because users communicate with the system using a stylus pen and tablet. Built-in design elements appear on the screen to be selected by touching the pen to the desired function.

By registering often used shapes and designs so that they can be called up with the touch of the pen, the user quickly reduces much of the drawing to one-touch operations.

The system which costs less than \$60,000 including software, will generate parts lists from information registered in the parts file and automatically calculate dimensions and enter them in the drawing. Full graphics features allow a user to zoom in on a window by specifying two points or pan with zoom by specifying one point.

Flat, roll and continuous paper plotters from A4 to A0 can be incorporated into the system and, with eight colour choices and an extremely fine resolution of 0.1mm on screen, can produce complete technical drawings of very high quality. Up to 21 complex drawings can be stored on

each 5.25in floppy disk.

By adding the appropriate extra software, companies can provide themselves with word processing facilities and an office management package.

## Assistant Series

IBM has introduced a new software family, the IBM Personal Computer Assistant Series.

Included in the series, which can be used with the full line of IBM PCs, is a word processing program that includes the Word Proof spelling verification aid, filing and graphing programs and a program that sorts and organises files and display or prints them in tabular form.

The Assistant Series programs are designed for easy use by first-time computers users, but are powerful enough to handle many sophisticated requirements, says IBM.

Information can be used with several of the programs in the series. For instance, information from the Filing Assistant program can be used with the Graphing Assistant to generate a graph or chart which can then be inserted in a report or letter prepared with the Writing Assistant.

# The BITS & BYTES Computer Book Club

## Catch up with Lotus 1-2-3

You're up with the play when you've got your own guide

- Buy any of these three and save \$4.50.
- Buy any two and save \$10.00 in total.
- Buy all three and save \$16.50 in total.

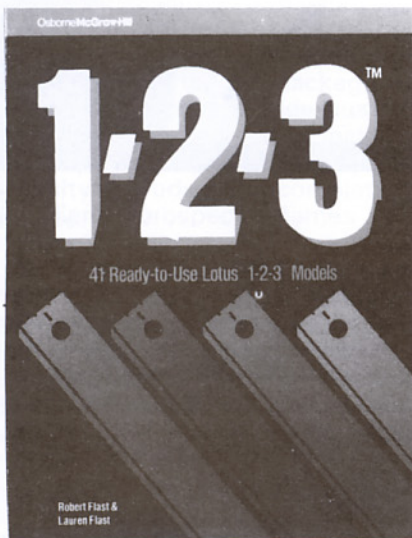

**Lotus 1-2-3 Simplified** David Bolcan  
Designed for all levels, it starts with installing and using Lotus 1-2-3, then moves through designing and using spreadsheets, formatting spreadsheets and making them aesthetically pleasing; generating printouts; working with oversized spreadsheets, graphics functions; data management; advanced spreadsheet applications and programming with macros. Attractive presentation includes many diagrams and graphs.  
TAB: **Our price \$29.60**

**Guide to Using Lotus 1-2-3** Edward M. Baras  
Detailed, comprehensive guide to help you make full use of Lotus 1-2-3's integration of spreadsheet, database and graphic functions. Includes step-by-step instruction on implementing practical application models for financial forecasting, consolidating business statements, simulating dynamic processes, electronic forms management. Equally useful to beginners and experienced users.  
Osborne/McGraw-Hill: **Our price \$38.80**

**1-2-3 Run: 41 ready-to-use Lotus 1-2-3 Models** Robert & Lauren Flast  
Collection of models that run on Lotus 1-2-3. Each model presented with a step-by-step description, complete listing, an illustration with sample data (you simply replace this with your own) and, where applicable, instructions to produce bar and line charts. Designed to simplify work, the models include applications for sales, accounting, real estate and the classroom.  
Osborne/McGraw-Hill: **Our price \$38.80**

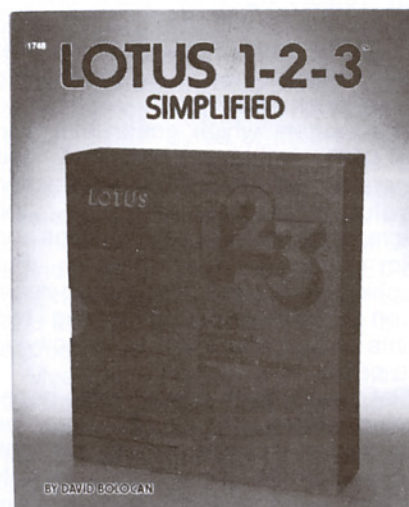
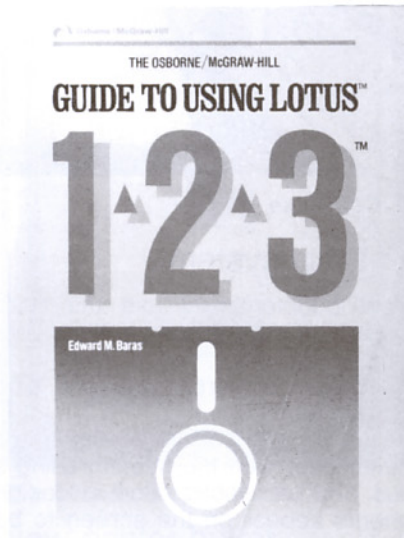

## Our new selection

### Multiplan: Home & Office Companion Elna Tymes & Peter Antoniak

Collection of models covering a broad spectrum of business and personal applications, personal finance, household management. Ready-to-use model described and accompanied by the listing needed to create the model and a sample printout. You just replace the sample data with your own. As you become familiar with Multiplan, the modelling techniques help you create customised models.  
Osborne/McGraw-Hill

**Our price \$36.95. Save \$3.00**

### Better Programming for Your Commodore 64 Henry Mullish & Dov Kruger

For those wanting to push the 64 to its full potential and improve their own programming techniques. After getting reader started on BASIC, the book looks at structured programming, numeric functions and logical operators, character string manipulation, arrays, nesting loops, audio-visual program enhancement, and debugging. Includes more than 90 programs.  
Fontana

**Our price \$16.65. Save \$1.30**

### Advanced Programming for the Electron Mike James & S. M. Gee

Aimed at users with some BASIC experience, and intended to extend programming skills. Discusses principles of good programming practice, data processing and file handling, achieving "user-friendly" programs; designing large programs, and how to find bugs concealed in completed code. Looks at using MOS, presents various utilities and deals with Boolean logic and bit manipulation.  
Granada

**Our price \$25.85. Save \$2.10**

### LOGO Anne Sparrowhawk

Systematic introduction to the facilities and applications of LOGO, including a thorough examination of its famous "turtle graphics". Explains the fundamentals and suggests how the language can most profitably be exploited. Explores command and syntax, and offers some ideas and projects to which LOGO can be applied. Plenty of programs to work with.  
Pan

**Our price \$24.95. Save \$2.00**

### MS-DOS User's Guide Paul Hoffman & Tamara Nicoloff

Sets out to familiarise you with MS-DOS in all its versions — IBM PC-DOS, and Versions 1.0, 1.1, 1.25, 2.0 and 2.1. Covers each computer running MS-DOS, gives the version it runs and lists any improvements the manufacturer has made to the system. Complete information on IBM PC-DOS. Information on software that runs under MS-DOS and products available to enhance the system.  
Osborne/McGraw-Hill

**Our price \$41.60. Save \$3.35**

### The Word Processing Handbook Katherine Aschner

Guide to word processing techniques and terminology, accompanied by many illustrations. Answers key questions for non-experts: what problems can word processing solve?, what are the pitfalls when buying a word processor?, how to select the right machine?, how does a word processor save time and money?, what's the best way to introduce word processing to the office?, what staff training is needed?  
Pan

**Our price \$12.00. Save 95c**

### Handbook of Procedures and Functions of the Electron Audrey & Owen Bishop

Ready reference to standard routines. Full listing of each procedure accompanied by an explanation of how it works and how to use it, and a description of what it does. Short, self-contained programs to teach beginners about BASIC and provide ready-made building blocks for modular programming for the experienced programmer.  
Granada

**Our price \$25.85. Save \$2.10**

**Business****Mastering Symphony****Douglas Cobb**

Business-oriented, hands-on approach by the author of two books on 1-2-3. Many examples and illustrations, and an attractive layout. Covers spreadsheets, database management, word processing, graphics, communications, command language, and offers tips on integrating the various functions. Packed with actual examples and practical applications.

Sybex **Our price \$72.00. Save \$5.90****Simply dBASE II****Barbara C. Chirlan**

Straightforward guide to get you going with this database management program. Teaches you enough so that you can use the parts you need, and explains how dBASE II handles information, what the program does with the information to make it useful, and how to retrieve information. Lots of illustrations and four appendices, listing — dBASE II commands, functions, configuration parameters and glossary.

dilitium **Our price \$21.20. Save \$1.75****Advanced dBASE II User's Guide** **Adam B. Green**

Collection of tips, techniques and practical problems tested and refined over two years of seminars around the U.S.A. Practical advice on software tools; controlling program flow; macros; strings numbers; dates; relational data model, other data models, repairing damaged data files; debugging; writing an add-on; hacking; benchmarks.

Prentice-Hall **Our price \$56.35. Save \$4.55****Business Program Portfolio for your Apple IIe; An Integrated Office System** **George H. Hildebrand**

Collection of 61 BASIC programs covering such office tasks as interest calculation, financial analysis, depreciation, property management and real estate, cash receipts and disbursements, job cost, payroll. All programs documented for implementation and modification. There is also guide to printing out business forms, creating a menu system, and securing business records with password programs.

Hayden **Our price \$36.00. Save \$2.95****On-Line Computing for Small Businesses — Silver's Wall****Maurice A. Silver, John Jeacocke & Ray Welland**

Sets out to provide managers of small businesses with a clear, concise but non-technical instruction in the use of on-line computing based on the practical experience of the authors. No prior knowledge of computing assumed and only essential technical definitions are included.

Pitman **Our price \$9.70. Save 70 cents****Computer Basic for Managers****Ralph Morris**

Demonstrates how to take charge of a computer right from the start. Provides practical guidance for managers on starting and developing a profitable computer operation — and will give a better understanding of the system. Discusses financial implications of computers, costs of hardware; software and personnel, and the benefits. Discusses the why, what and how of both mini and microcomputers in simple language.

Hutchinson **Our price \$56.65. Save \$4.60****The ABCs of 1-2-3****Chris Gilbert & Laurie Williams**

Hands-on approach using detailed, step-by-step instructions. Lessons involve tackling projects such as building a worksheet, displaying the worksheet as a graph, building a database, simplifying several operations using macros, performing calculations and printing graphs and reports. Remains a handy reference once you are familiar with 1-2-3.

Sybex **Our price \$37.85. Save \$3.05****Doing Business With Multiplan****Richard Allen King & Stanley R. Trost**

Quick, well set out guide presenting more than 20 accounting and management planning applications for the business user. Each is thoroughly described, and a complete template for setting up the application in Multiplan presented. Many usable "as is"; others can be modified for specific problems. Covers record keeping, financial statement analysis, sales finance manufacturing, master budgeting.

Sybex **Our price \$46.60. Save \$3.75****Symphony Encore Program Notes** **Dick Andersen**

A computerside companion to provide help when you need it. Offers new ideas and techniques to make working with Symphony easier, more efficient and more productive. Offers solutions to common problems and typical situations. Practical information on tips and traps. Book is organized according to functions such as spreadsheets, word processing, graphics, communications and database management. Entries are modular and there are numerous illustrations and diagrams.

Sybex **Our price \$61.00. Save \$4.95****The Complete Guide to Multimate****Carol Holcomb Dreger**

Comprehensive source of information for business users. Covers features, functions and applications, and procedures for editing, filing, copying and formatting in tutorial fashion. Emphasis on practical applications and instructions geared to the IBM PC and its compatibles.

Sybex **Our price \$44.35. Save \$3.60****Understanding dBase II****Alan Simpson**

Clear, concise text and eye-catching graphics help you master the basics, then guide you through programming techniques for useful applications such as mailing label systems, graphics, bookkeeping, printing and formatting reports. You also learn to interface, dBASE II with other software systems to expand its capabilities.

Sybex **Our price \$47.65. Save \$3.85****Databases for Fun and Profit****Nigel Freestone**

For users wanting to do their own programming. Provides straightforward introduction to data processing, with explanations of routines in BASIC. Examples of system designs for home and business use, which you can combine and expand. Systems for names and addresses, catalogue index; diary; stock control; bank account/budgeting; debtors list/sale/purchase ledger; payroll.

Granada **Our price \$18.45. Save \$1.50****Language/programming****The MS-DOS Handbook****Richard Allen King**

An in-depth look at MS-DOS's internal functions, showing how to get the most out of the operating system, how to eliminate repetitive operations and how to streamline common procedures. Covers file structures and disk layout; changing the meaning of keys; using serial and parallel ports; looking inside the system with DEBUG; information for programmers using advanced MS-DOS functions. Covers various MS-DOS versions, and has tables, maps and many practical examples.

Sybex **Our price \$46.20. Save \$3.75****Structured Programs in BASIC****Peter Bishop**

Opens with a discussion of program structure and design. The rest of the book comprises example programs, with the complete program design process (from initial specification to final listing) carried out. Excellent source of programming techniques, algorithms, program modules, ready-to-run programs and ideas.

Nelson **Our price \$25.65. Save \$2.10****Learning BASIC for the Macintosh****David A. Lien**

Comprehensive, attractively-presented guide organised into five major sections — discussion and exercises on the Mac's capabilities; answers to the exercises; some users' programs; appendices providing reference tables and charts; an index. Easy-to-follow language and all computer terms explained as you go.

Composoft **Our price \$53.20. Save \$4.30****Apple****Getting Started With ProDOS****B. M. Peake & D. Rorke**

Aimed at Apple II and IIe users, this is intended for someone familiar with the existing Apple DOS 3.3 systems. Comprehensive guide to ProDOS, with exercises for practice. Reference section goes over commands and comments on their use, and there is a discussion of the advantages and disadvantages of the system. A list of further references is included.

Bluewater Press **Our price \$6.45. Save 50 cents****Games for Your Apple IIe****Tony Dyson & Bjorn Englehardt**

More than 20 programs including Phaser, Howzat, Snake, Simon Says, Cannon and Jackpot. Plus a chapter on how to write better programs and a glossary.

Virgin **Our price \$12.90. Save \$1.05****Applesoft Basic: A Teach-Yourself Introduction****B. M. Peake**

Second edition revised to cover the Apple II Plus and IIe. A manual for New Zealanders to learn BASIC with the Apple, instead of picking information from two or three sources includes model answers. Enquiries for class sets welcome.

McIndoe **Our price \$12.90. Save \$1.05****Spectrum****An Expert Guide to the Spectrum****Mike James**

Practical introduction to the Spectrum's advanced hardware and software features. Aimed at the user seeking a deeper understanding of the machine and its capabilities. Starts with an inside view of the micro, then moves to a connoisseur's guide to ZX BASIC and an introduction to the machine operating system. Covers ZX video, tape system, RS232 interface, microdrive and advanced programming techniques. Complete program listings and projects for further exploration.

Granada **Our price \$23.10. Save \$1.85****The Sinclair User Book of Games & Programs for the Spectrum**

Sixty games and programs from the Spectrum magazine, Sinclair User; protect your castle from invading soldiers in Siege; test your three-dimensional sense in Labyrinth; improve your geography in Mapwork; face Mr Spec Trum on Wimbledon's centre court; run your own cricket test at Lords; jump a clear round in Olympia; play noughts and crosses against the computer; sink a submarine in Depth Charge; tackle a crash typing course in Touch Type.

Penguin **Our price \$12.90. Save \$1.05****Practical Spectrum Machine Code Programming** **Steve Webb**

Designed for programmers who want to write faster and better programs than they can in BASIC. Assumes you have no knowledge of machine code and works through the details to the point where you are linking routines and using routines with BASIC programs. Questions throughout to test progress.

Virgin **Our price \$18.05. Save \$1.45****Adventures for Your ZX Spectrum****Clive Gifford**

Six ready-to-run adventure games — Crash! Pearl Diver, The Ring of Power, The Seven Keys of Tarkus, School's Out and Everyday Adventure — plus advice on writing your own adventures and a glossary and bibliography.

Virgin **Our price \$13.85. Save \$1.10****Spectravideo****Spectravideo Computing****Ian Sinclair**

Suitable for all models, this book offers a comprehensive guide to setting up and getting started, then progressing in easy stages through many examples to explore the world of the Spectravideo.

Granada **Our price \$27.70. Save \$2.25****Games For Your Spectravideo****Damon Pillinger & Danny Olesh**

More than 25 programs including Minefield, Road Race, Star Strike, Towers of Doom and High Fighter. Plus a series of graphic demonstrations and a chapter on making effective use of the Spectravideo's sound.

Virgin **Our price \$12.90. Save \$1.05****BBC****The Second Book of Listings****Martin Bryant**

Eighteen games (reflex/reaction, tactical, puzzle, strategy, demonstration) programs for the BBC Model B. Plus a simple, general-purpose word processor in 6502 assembly code and tutorial for beginners in writing adventure games.

**Our price \$14.10. Save \$1.15****Further Programming for the BBC Micro****Alan Thomas**

Uses more than 90 programs to demonstrate the BBC's special features. Listings accompanied by notes on points of interest and hints on extending and improving the programs. Further ready-to-run programs also included.

Shiva **Our price \$23.10. Save \$1.85****BBC Micro Assembly Language****Bruce Smith**

Covers hexadecimal and binary; the registers; the mnemonic assembler; absolute and indirect addressing; stacks and flags; MOS routines. Full uncensored description of CALL and USR, showing how strings and variables can be passed into machine code programs. Appendices include description of 6502 chip's 56 instructions machine code graphics and sound, including PLOT, SOUND and ENVELOPE.

Shiva **Our price \$27.70. Save \$2.25****Practical Programs for the BBC Micro****Owen & Audrey Bishop**

Fourteen programs for home and business accounts; stocktaking; cash flow; space planning in house, garden or office; decision making; indexing; database. Full instructions and suggested applications provided along with tips on matching programs to your special needs.

Granada **Our price \$23.10. Save \$1.85****Easy Programming for the BBC Micro****Eric Deeson**

Looks into complexities of animation, strings, use of flowcharts, editing, arrays, sound capabilities and includes a case history of a bugged program. Forty ready-to-run programs to give further ideas as a yardstick.

Shiva **Our price \$21.20. Save \$1.75****How to Write Adventure Games for the BBC Model B & Acorn Electron** **Peter Kilworth**

Designed for those who have started programming in BBC BASIC. Teaches how to create and write fairly complicated adventure games, though the text is structured so that simple games can be written early on. Three games created, and a multipurpose "shell" adventure program and database creation program provided.

Penguin **Our price \$15.70. Save \$1.25**

**IBM****IBM PC Programming****Richard Hesckell & Glenn A. Jackson**

Hands-on, step-by-step approach for beginning and advanced programmers. Uses actual photographs taken from the computer screen in graphic examples to develop many fundamental programming concepts. Includes information on string variables and functions, IBM PC DOS: numerical variables and arithmetic; expressions; sound effects; medium resolution graphics; loops and subroutines; bar graphs; animated graphics.

Prentice-Hall

**Our price \$27.10. Save \$2.20****The IBM PC-DOS Handbook****Richard Allen King**

A complete guide intended to give you confidence to be creative with your computer's capabilities. Reveals features and functions inside PC-DOS, what you can do with them, and how they go together. Second half of book shows how to become adept at using PC-DOS's more advanced features.

Sybex

**Our price \$20.30. Save \$1.65****The IBM PC Connection****James W. Coffron**

From the author of the popular Apple Connection, VIC-20 Connection and Z80 Applications, this book shows how easy it is to use your computer with common household devices. Explains techniques for setting up your IBM to control a home security system, home temperature control system, voice synthesizer to make your computer talk, as well as other home appliances.

Sybex

**Our price \$22.70. Save \$2.25****Data File Programming on your IBM PC****Alan Simpson**

Presents the techniques for writing BASIC programs for mailing list systems, grade books, library referencing system, graphic displays. Covers adding files, searching, sorting, editing and printing formatted reports.

Sybex

**Our price \$32.30. Save \$2.65****IBM BASIC: An Introduction to Programming in BASIC on the IBM PC.****Donald T. Payne & William R. Beck**

Each chapter opens with a problem-solving situation encouraging you to think on your own and experiment for a deeper understanding of the principles involved. Simple problems in early chapters teach you how to use, understand and modify programs. Gradually, the emphasis changes to creation of your own programs for business, home and entertainment.

Prentice-Hall

**Our price \$35.15. Save \$2.85****Useful BASIC Programs for the IBM PC****Stanley R. Trost**

A selection of tested programs for more than 65 home and business tasks. Home finances, business calculations, real estate, data analysis, record keeping and education are some of the fields covered. No knowledge of BASIC programming is needed to use these programs.

Sybex

**Our price \$18.45. Save \$1.50****IBM PC for Kids from 8 to 80****Michael P. Zabinski & Francis H. Short**

Easily followed, fun book covering the most important programming concepts. You are encouraged to try as many examples as possible. Includes "instant replays" for second explanations, experiments, challenges, exercises (and answers, just in case), review checkpoints, recreation and funtime.

Sams

**Our price \$31.00. Save \$2.50****Computer Playground: IBM PC****M. J. Winter**

Based on a child's interest in words, games and graphics, this collection of BASIC computer activities presents each as "problem" in workbook format geared to the children's level. They type in and run sample programs, learn how to modify them and complete partially written programs. Commands are introduced progressively.

Reston

**Our price \$21.90. Save \$1.80****Using Your IBM Personal Computer****Lon Poole**

After previous popular books on the Apple II, BASIC and the Atari, Lon Poole has now turned to the IBM PC. This comprehensive book is in two parts — for those who want to use only packaged programs; and for those who have never programmed a computer but want to learn BASIC programming. Also includes familiarity chapters with the hardware, sections of graphics and sound, and summaries of BASIC, PC DOS, error messages and characters, codes and keystrokes.

Sams

**Our price \$32.85. Save \$2.65****MS-DOS & PC-DOS on the IBM-PC****Charles Jackson**

Full guide to understanding the operating system and its use, allowing you to master the commands which take care of disk "housekeeping" tasks and let you move on to bigger and better computing. Dissects the two DOSes — what they are, how they work, what they can do and how to use them, includes section on special considerations for hard-disk users and a summary of DOS commands.

Prentice-Hall

**Our price \$32.95. Save \$2.65****Games****The Big Fat Book of Computer Games****Tim Hartnell**

Contains 34 games written in the most general form of BASIC, making them suitable for most computers. Includes board, adventure and space games, brain teasers, simulations — and some just for fun. Spread over 389 pages, programs are clearly printed and accompanied by notes.

Interface

**Our price \$27.70. Save \$2.25****Tim Hartnell's Giant Book of Spectrum Games**

More than 80 programs covering just about every sort of game imaginable — arcade action, mind benders, chance and skill, adventure, space, board and card, fun, simulations. And there are utility and demonstration programs, games to convert notes on error trapping and a glossary.

Collins

**Our price \$13.85. Save \$1.10****Tim Hartnell's Giant Book of Computer Games**

More than 40 games compatible with Microsoft BASIC able to run on most micros, including BBC, VIC 20, Oric, Apple II and IIE, Commodore 64, Dragon 32, Tandy Color, IBM PC, Laser, TRS-80, PET, MZ80K and Spectrum. Range covers board, dice, space, brain and adventure games, simulations, artificial intelligence, and some just for fun.

Collins

**Our price \$13.80. Save \$1.15****40 Educational Games****Vince Apps**

Editions for the Commodore 64 and the Electron. Developed with the help of educational lists and a professional programmer, programs have been designed to help younger family members handle the machine and increase their general knowledge. Subjects include languages, geography, mathematics and science. Hints show how program contents can be changed to suit the family as skills develop.

Granada

**Our price \$18.45. Save \$1.50****Virgin Computer Games Series****Edited by Tim Hartnell**

Each book contains a selection of more than 20 games which allow you to hone programming skills as well as have plenty of fun. Contains brief dictionary of computer terms, bibliography and hints on how to improve and extend some of the programs.

**Commodore 64 edition \$11.05. Save 90 cents****Spectrum, ZX 81, TRS-80, VIC 20, Oric,****Dragon, Atari, BBC editions \$8.30. Save 75 cents****Atari 600XL edition \$14.75. Save \$1.20****Commodore 64****Commodore 64 Machine Language Tutorial****Paul Blair**

Get to grips with the intricacies of machine language programming, helping you overcome the demanding, exacting and sometimes exasperating requirements. But master it and tasks such as sorting, searching and some graphics become much quicker. Judicious use of machine language also allows you to use larger and more complex programs. Demonstration program provided, with examples of short machine language routines.

Holt-Saunders

**Our price Book & disk \$53.20.****Save \$4.30****Book & cassette \$50.85. Save \$4.10****Data Handling on the Commodore 64 Made Easy****James Gatenby**

Data processing — sorting raw facts to produce useful information — can be just as rewarding as playing games. Explains how to use the Commodore 64 to process information for the home and small business. Uses straightforward examples to demonstrate storage of large quantities of data, attractive and readable on-screen display, and searching and print-outs.

Granada

**Our price \$20.30. Save \$1.65****The Commodore 64 Program Book****Vince Apps**

Collection of adventures, games and utilities to exploit the C64's colour and graphics. Adventures test logic and deduction; wide range of arcade-style games; utilities include versatile assembler/disassembler program.

Phoenix

**Our price \$22.15. Save \$1.80****First Steps in Machine Code on Your C64****Ross Symons**

Clear, concise explanation of machine code — introduction to the disassembler and its use; instructions for the 6510 chip with the aid of a demonstration program; discussion of the kernel operating system and its applications such as printing, input/output devices and scanning the keyboard. Two complete machine code games show you how to create your own high speed, animated arcade-like games.

Corgi

**Our price \$12.00. Save 95 cents****Adventure Games for the Commodore 64****R. J. Bradbury**

Starts with stories and character creation and works through to the technical programming tricks found in top commercial games. Numerous examples and programs included and these can be incorporated into your own games.

Granada

**Our price \$23.10. Save \$1.85****Commodore 64 Machine Code Master: a library of machine code routines****David Lawrence****& Mark England**

Provides full listing and explanation of Commodore 64 master code assembler, then offers a collection of tested machine code routines to extend C64 BASIC with more than a dozen new commands. All routines fully explained, providing an introduction to a wide range of programming techniques and ways in which the C64 ROM can be used to best advantage by the machine code programmer.

Reston

**Our price \$24.15. Save \$1.95****The Commodore 64 Survival Manual****Winn L. Rosch**

A complete guide to the 64 — from programming to problem solving. Covers creating and connecting a system; getting started; programming step by step; storage; printers; modems; care and feeding; troubleshooting; software; peripherals; user support.

Bantam

**Our price \$18.45. Save \$1.50.****Advanced Machine Code Programming for the Commodore 64****A. P. & D. J. Stephenson**

Details the 6502/6510 microprocessor with particular attention to the multiple-byte handling and high-resolution graphics. Number of fast sorting routines are described and methods outlined for using machine code to improve the speed and smoothness of animation and sound. Many examples as illustrations and for practical use.

Granada

**Our price \$30.50. Save \$2.45****Commodore 64 Assembly Language****Bruce Smith**

Comprehensive introduction to assembly language with plenty of sample programs and a full description of the 64 instructions the 64 understands. All programs designed using DATA statements so that you can key them in and go. Mnemonics included for those with an Assembler. Gets into hex and binary; registers and flags; jumps, shift and rotates; the Kernal; and machine code sprites.

Shiva

**Our price \$25.85. Save \$2.10****Basic Subroutines for Commodore Computers****Eddie Adams**

Easy-to-use manual which offers access to more than 300 BASIC subroutines — powerful building blocks you can combine and adapt to create programs for a wide range of business, educational and personal applications. Explanations for each subroutine with suggestions for modifying it to your needs. Each program is ready to run on any Commodore system.

Wiley &amp; Sons

**Our price \$29.55. Save \$2.40****Commodore 64: Basic Programs in Minutes****Stanley R. Trust**

Collection of versatile, ready-to-enter programs for more than 65 home and business tasks on the Commodore 64. Programs for home finances, business calculations, real estate, data analysis record keeping and education. No knowledge of BASIC programming needed to use programs which can be entered and ready to run in less than 10 minutes.

Sybex

**Our price \$26.80. Save \$2.15****How to Program the Commodore 64 — if you've never programmed a computer before****Robert Young**

After an introduction to the bits and pieces of the 64, you move to the process of learning to program on the keyboard. Concentrates on the key words and techniques to have you writing programs as quickly as possible, then allows you to refine the process at your leisure.

Interface

**Our price \$21.20. Save \$1.75****How to Use The Commodore 64****Jerry &****Deborah Willis**

Introduction to the computer and its basic components, explains what the components do and how they work together; step-by-step instructions on setting up and installation, shows how to load and save programs on diskette or cassettes, tells how to type in, use and modify programs; presents other sources of information.

dillithium Press

**Our price \$8.30. Save 65 cents****Keyboarding****Keyboarding for Information Processing****Robert Hanson**

Enables a person to develop basic touch keyboarding skill in a minimum time. The person who completes the book will be able to key in alphabetic, numeric and symbol information; input numbers on a separate 10-key pad; keyboard information quickly and accurately; understand some of the basic vocabulary used in keyboarding. Can be used for classroom or individual, self-instruction.

Osborne/McGraw-Hill

**Our price \$8.85.****Save 70 cents****Quick Keyboarding****Vonnie Alexander**

Sub-titled "Competent Keyboarding in 6 Hours", this book by New Zealander Vonnie Alexander has a unique method for teach-yourself competent keyboarding. A wall chart of finger positions is included.

Methuen

**Our price \$6.45. Save 50 cents**

# Our new selection

## The MBASIC Handbook

Walter A. Ettl  
& Gregory Solberg

Concise, graduated tutorial to help you build programming skills for use in business, education and personal applications. Covers MBASIC tools; describes statements, functions, commands and operators; works with loops, strings, arrays and subroutines; sequential and random access files; debugging and documenting programs. Includes five fully documented business programs which can be customised.

Osborne-McGraw Hill

Our price \$40.75. Save \$3.30

## Working With Easy Script

Randall McMullan

A working guide to Commodore's word processing package. Beginners can use part one to start word processing. If you've used Easy Script before, the prompts will remind you of commands and point the way to more advanced facilities. Part two includes further details and techniques, with critical examples of common applications.

Granada

Our price \$20.30. Save \$1.65

## Play LOGO: An Invitation to Computing for Parents and Children

John Cunliffe

Anyone who can operate a television set and a typewriter keyboard should enjoy this book written for the young learner and the interested adult. Tells how to choose a computer for LOGO, how to write your own programs, and suggests projects and puzzles. Attractive format and easy to follow.

Andre Deutsch

Our price \$16.20. Save \$1.30

## Basic Programs for the Atari 600XL & 800XL

Timothy Orr Knight

A learn-by-doing handbook which starts with easy programs and works through hands-on experience to more advanced programming techniques, with explanation and guidance along the way. Twenty complete program listings range from the simple to the more complex. Each is designed to illustrate a facet of the Atari's potential.

TAB

Our price \$25.85. Save \$2.10

## The BBC Micro Gamesmaster

Kay Ewbank, Mike James & S. M. Gee

Shows you how to develop your own games as you learn the techniques of the professional games programmers. You also pick up the skill of solving programming problems as they arise. Programs are structured so that each procedure, or module, performs a distinct task allowing variations on the "core" program to be written by substituting new modules. Also advice on how to customise your programs.

Granada

Our price \$20.30. Save \$1.65

## Computer Wimp

John Bear

A humorous and sympathetic treatment of the bafflement computers can pose for the novice and impatient. Deals with buying a computer; breakdowns and repairs; "technobabble" and how to talk to computer people; computer crime, piracy, health hazards and games; the promise of "even better" to come; why it doesn't matter if you don't join in.

Hutchinson

Our price \$23.80. Save \$1.95

## Invaluable Utilities for the Commodore 64

Clive Emberey & Bob Turner

A toolkit of programming aids, BASIC enhancements and timesaving utilities. Includes BASIC versions of programming utilities such as autoline number, block delete, renumber and program merge routines; programmable function keys are covered; and the 64's peripheral potential investigated. BASIC utilities, plus trace, variable dump, procedure, graphics routines and many others are then implemented in machine code. BASIC loaders provided along with a complete monitor listing for entering the routines.

Pan

Our price \$27.70. Save \$2.25

## Getting Started In Pascal Programming

Jose Camara & Frederick Puccetti

Sets out to provide the beginner with an easy approach to programming Pascal through practical examples. Aims to enhance your programming background in Pascal and promote well-constructed, well-documented programs. Development of simple programs demonstrated, with examples leading to the creation of complex algorithms and programs.

TAB

Our price \$36.55. Save \$2.95

## Armchair BASIC: An Absolute Beginners' Guide to Programming in BASIC

Annie & David Fox

Easily-followed introduction — you don't need a computer to learn. Blends numerous examples and illustrations in a good-humoured explanation of programming concepts. Guides you through BASIC programming fundamentals, shows how a computer can use your input to produce useful results, and presents a glimpse into the computer future.

Osborne/McGraw-Hill

Our price \$27.75. Save \$2.20

# Program the C64

Buy both and save \$3.00

## Step-by-Step Programming: Commodore 64

Phil Cornes

Two books of original, teach-yourself programming and more than 150 screen-shot photographs of listings and programs, showing exactly what appears on screen. Programming tips and techniques, reference charts and tables, and advice on getting the most out of your C64.

• Book 1: Setting up and starting; inside your computer; screen layout and how to control it; computer conversations; programming with sprites; animation; special effects; compiling a databank.

Doubleday

Our Price \$12.00. Save 95 cents



• Book 2: High resolution programming; curves and circles; "natural" graphics; designing your own characters; sprite animation, overlaps and collisions; pies and slices; bars and graphs; guide to writing games; shaping sound.

Doubleday

Our price \$12.00. Save 95 cents

## The Basic Explorer for the Commodore 64

Lee Berman & Ken Leonard

Written as a suspense novel and an instructional text, this teaches introductory programming in BASIC. Through the adventures of three modern-day explorers, the authors introduce both the elements of C64 BASIC and the thought processes that go into designing a computer program to solve a problem.

Osborne/McGraw-Hill

Our price \$27.75. Save \$2.20

## 40 Educational Games for the Atari/Vic 20

Vince Apps

Designed to help young users improve both their computer and general knowledge through games. Subjects include languages, geography, mathematics and science, with hints on how programs can be changed to suit advancing skill levels. Note: separate book for each machine.

Our price \$20.30. Save \$1.65

## The Companion to the Sinclair ZX Microdrive and Interfaces

Stuart Cooke

Sets out to explain the function of all parts of the system, how they interface with each other, with peripherals and via the local networking facility. Possibilities for communication with printers and other computers explored, and programming operations detailed and illustrated with applications programs.

Pan

Our price \$24.95. Save \$2.00

## Your IBM PC Made Easy

Jonathan Sachs

Covers the fundamentals and details major features of the system, including coverage of DOS 2.0 and the PC XT. Step-by-step operating instructions, and a guide to resources — what you need to know about dealers, software, services and accessories. Reference guide to operations and troubleshooting for common problems.

Osborne/McGraw-Hill

Our price \$29.55. Save \$2.40

## 1001 Things to do With Your Apple

Mark. R. Sawusch & Tan A. Summers

A goldmine of ideas of what you can do with your Apple, along with programs, printouts, flowcharts, diagrams, and instructions on using the micro in fun ways.

TAB

Our price \$27.70. Save \$2.25

## Commodore 64 Fun and Games

Ron Jeffries, Glen Fisher & Brian Sawyer

Proven collection of 35 games and puzzles, complete with instructions and complete BASIC program listings for each game. Games include Bat, Everest and Yahtzee.

Osborne/McGraw-Hill

Our price \$27.75. Save \$2.20

## The club: how it works and what you get

All you have to do to join the club is buy a book. Just pick out the books you want, fill in the coupon in the middle of the magazine, and post it in FREEPOST.

We offer savings on the cash price you pay for each book

Please allow two or three weeks for orders to be processed and the book distributors to get the books to you.

## 50 Simple Ready-to-Run VIC-20 Programs

Barbara Fulgham

All programs ready to type in, with straightforward instructional chapters. Covers maths ideas and problems; programs to cope with daily chores; instruction on setting up your own graphics to enhance programs; 16 games; making music on your computer; system, devised exclusively for the VIC, to put recipes on computer tapes.

TAB

Our price \$19.90. Save \$1.60

## The Commodore 64 Experience

Mike Dean Klein

The many and varied uses of a home computer — programs for the home (recipes, shopping, phone books, kitchen metrics, budgeting); education programs (maths, geography, spelling, languages, graphics); entertainment programs; business programs (appointments, cash flow, interest, cheque books, inventory); utility programs (sprite creation, character design, memory loader, saver and clear; disk menu, menu ideas). All programs can be modified.

Reston

Our price \$31.80. Save \$2.60

## Cracking the Code on the Sinclair ZX Spectrum

John Wilson

Practical machine code programming guide allowing the user to harness the full power of the Spectrum's hardware and escape the confines of BASIC. You are introduced to Z80 instruction set and learn to combine the various elements of machine code in commercial-like programs. Annotated example programs allow you to enter and use fast screen handling routines and sorts in your own programs, debug them with the trace facility, and run them with the on-screen clock. Covers ROM routines, interrupt handling and programming principles.

Pan

Our price \$24.95. Save \$2.00

## Made Easy BASIC — editions for Spectrum, BBC, VIC-20, Electron, Commodore 64.

Garry Marshall

Each book has two aims — to provide an easily understood introduction to BASIC; to be used with the relevant computer. Each book covers: features of BASIC; first programs; writing, storing and displaying a crossword puzzle; displays and BASIC functions; writing extensive programs; writing a computer game; a space invader program; writing a database program; creating graphics and sounds.

Arrow

Our price \$15.50 each. Save \$1.25

## A User Guide to the UNIX System

Rebecca Thomas & Jean Yates

Twelve extensive tutorials take you from initial log to advanced program control and input/output procedures. As you go, you gain an understanding of the purpose of UNIX features and the character of the system. Special emphasis on word processing and the most commonly-used commands. Error messages explained and an appendix on how to oversee the system's operation. Complete coverage of all major releases of UNIX.

Osborne/McGraw-Hill

Our price \$41.60. Save \$3.35

## Invaluable Utilities for the Electron

Jeff Aughton

Software toolkit for constructing programs, disassembling them and sorting out bugs. Full explanation of use and mechanics of each utility. Utilities include disassembler, music processor, bad program fix, sorts, and a mode 2 character creator and plotter routines.

Pan

Our price \$27.75. Save \$2.20

## Fun, Games & Graphics for the Apple II, IIe & IIc.

Paul Garrison

Collection of more than 75 ready-to-run programs which you can use, study, modify, combine and experiment with. Complete listings written in standard Applesoft BASIC and CP/M-supported BASIC-80, and explanations. More than 20 financial and record-keeping programs, and a wealth of graphics and education programs, a word processing program and some small-scale database programs.

TAB

Our price \$39.75. Save \$3.20

# Assurance from Aussie

Aetna Life and Casualty, in New Zealand, is promoting a software package developed by its Australian office primarily for use by agents in the field.

Assure is a comprehensive and user friendly package rapidly finding support among independent agents who are able to file information back to the central office or even access the Sydney-based mainframe where a suite of 20 programs for client presentation is held.

Agents need an IBM compatible machine with a 10 megabyte hard disk which runs MS-DOS and PC-DOS for the package which incorporates a general ledger.

Security coding built into the package allows access to different levels, depending on seniority, and the Report Writer program accommodates data analysis with the user nominating any of a large range of detail requests.

Gavin Austin, general manager of Aetna Life and Casualty in Auckland, says the package is making an impact on internal office management as well as maximising efficiency for brokers and agents in the field in record keeping, minimising staff requirements and helping make time spent on record keeping efficient.

## Semiconductor agency

David Reid Electronics, Ltd, has been appointed the New Zealand agent for Semi Processes Inc (SPI) of San Jose, California.

SPI is a semiconductor house specialising in CMOS/DMOS F.E.T.s and 74HC/74HCT CMOS logic products.

The SP74HCT series has been designed to interface directly with standard TTL logic levels, while the SP74HC series is designed to interface at standard CMOS logic levels.

By the end of this year, SPI expects to offer at least 115 CMOS logic devices as standard off-the-shelf products. The HCT family is concentrated in the buffering/interface role, making the advantages of CMOS in existing systems immediately available to the user. The initial products offered in the HC family allow construction of complete systems from the gate level, and the family will be expanded to meet user needs. Both families are complementary to SPI's series of semi-custom, gate array products.

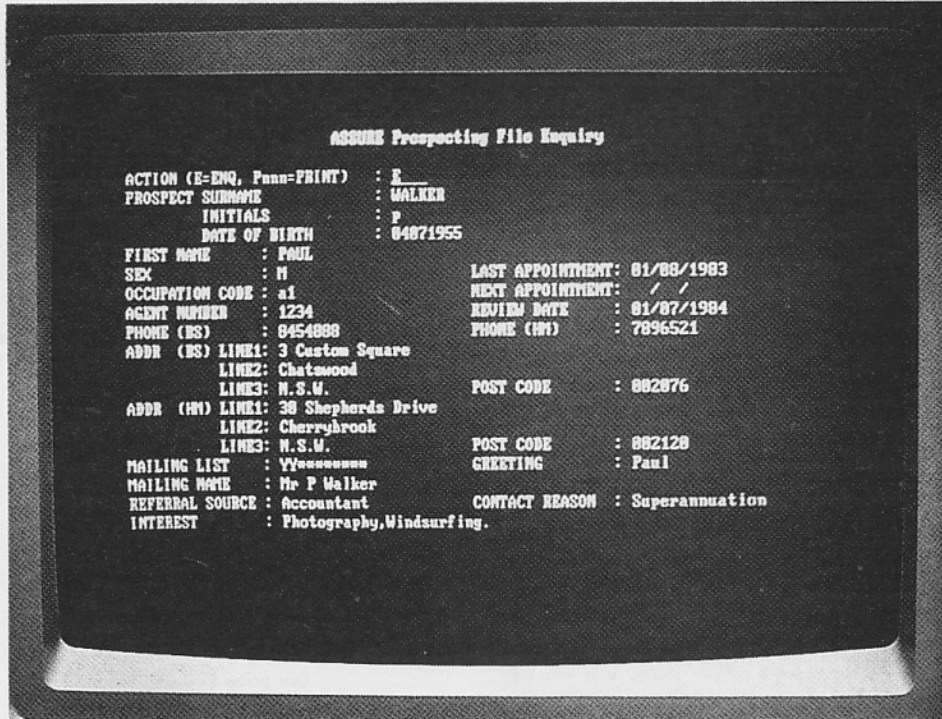

A sample of an Assure prospecting enquiry.

## PAL support

A powerful, new software package, now available from GTS Engineering supports any AMD programmable array logic (PAL) device. Programmable Logic Programming Language supports AMD's second-generation AmPAL22V10 24-pin PAL device and assists design efficiency for other AMD PAL devices.

Written in C programming language, it uses a high-level, block-structured hardware description approach to increase the efficiency of logic design using programmable logic devices. Because they are database driven, future AND-OR PAL devices can be supported by updates of the device library.

The software package supports such high-level constructs as IF-THEN, IF-THEN-ELSE, FOR, CASE, and FUNCTION calls, and has MACRO substitution capability. The hierarchical language design provides the flexibility and portability to run on various computer operating systems, including IBM DOS 2.0, UNIX 4.2, and VMS. The package's menu-driven interface, and extensive "help" commands combine to ensure ease of use.

## New flight

A new version of Microsoft Flight Simulator is now available in NZ through Interactive Applications Ltd.

This enhanced version, which runs on the IBM PC, allows users to use the flying skills in a true-to-life flying environment and has more detailed scenery and life-like plane performance features, helping to create the feeling of flying in a real aircraft. Suggested retail price is \$140 and there is no upgrade for earlier versions.

## Uniplex for UNIX

Auckland-based Rakon Computers Ltd (P.O. Box 25-213) has been appointed to distribute the range of Uniplex software, from the British firm, Redwood.

Uniplex, a suite of programs for UNIX environments, is written in C. Packages within the system include a word processor, a spreadsheet capable of handling 32,767 columns by 1000 rows, and a fully relational DBMS.

For systems developers, there is a range of toolkit programs including a menu system; a print spooler; and a command screen builder.



# MacDrive hard disk products for the Apple Macintosh

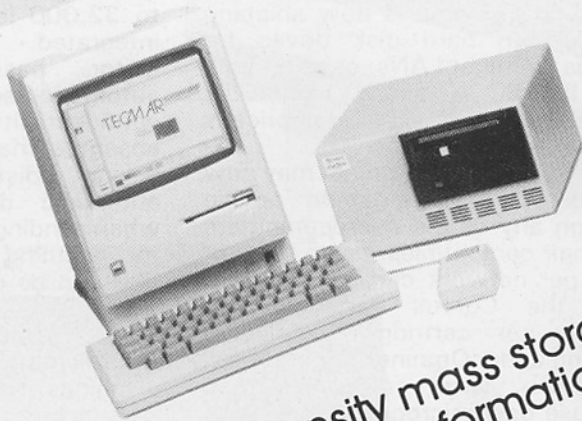

Provides high density mass storage  
Stores 38 times more information than the  
Macintosh microfloppy.  
Allows information sharing between several  
Macintosh computers  
Transportable 5 MByte Removable Hard Disks  
10 MByte Fixed Hard Disk  
Four configurations available  
Includes all cables and software needed to  
have your MacDrive installed and running  
in minutes

# TECMAR

THE 3rd DIMENSION

DEALER ENQUIRIES MOST WELCOME

171 Grafton Road

PO Box 3407

Telex NZ 60074

Telephone 798005

Auckland

**SOUTHMARK ELECTRONICS LTD**

A MEMBER OF THE PAXUS GROUP OF COMPANIES

# New wholesale company

Arcom Pacific (NZ), a new company formed to wholesale programs from Ashton-Tate, Digital Research and Sorcim, has been set up in conjunction with ISIS, a Hamilton-based company established five years ago to provide software for mini and microcomputers. It has also developed general applications packages.

Systems director Geoff Orchard heads the company and the marketing director is Kerry Peart-Baillie who says they have been working closely with Ashton-Tate in the USA for the last five years.

Eike Zimmerman, managing-director of The Computer Store which has been selling the Ashton-Tate, Digital Research and Sorcim software packages since May this year, will continue to supply this range through an arrangement with Arcom Pacific, Australia.

He is offering a trade-in on dBase II for the new dBase III package. Providing the dBase II package is legitimate, users can trade it for dBase III at \$499, with \$50 for air freighting. The normal retail price of \$1447.

This version of dBase runs on 16-bit machines and because it has been written in C-Compiler, is faster. Users intending to trade in will also need to supply the original master diskettes and manual.

## Enhanced business WP

Apple Computers has released an enhanced version of Apple II word processing software for personal business computers.

Based on ProDos, this software can work with Apple's profile hard disk, carrying between 30 and 50 times more information than possible with a floppy disk. It also works with the Catalyst IIE from the English company, Quark Inc. The Catalyst is a program selector which allows Apple IIE programs to be stored on hard disk.

The built-in Catalyst IIE file allows users to move from one application to another without having to restart the computer each time a program is switched.

In New Zealand, the upgrade will be offered at discount to owners of the earlier version, and the package includes a training disk which will take new users step by step through the program.

New features include horizontal scrolling, a text display which does not require to print out to see the page and line count, a built-in terminal mode for computer links and for those without ProDos, a utility which formats a blank disk for use with the Apple II.

## Micros only

Corvus Systems is now shipping 126Mb 5th hard disk drives for Corvus Omninet LANs, or as an add-on to IBM PC, AT and XT, Apple, TI, DEC Rainbow etc. The retail price is about \$20,000.

Users of Corvus Omninet may now access up to a gigabyte on-line through any of the microcomputers and their compatibles, as up to eight units per network can be attached. With the Corvus Bank offering 200Mb per cartridge drive also working under Omninet, for back and load-down, large companies may now use only microcomputers, with a mixture of makes in the same network.

## 2m Apple IIs

Apple Computer has announced it has produced its two millionth Apple II personal computer at its Texas manufacturing plant.

Since the first Apple II was introduced in 1977, there have been 15 revisions to the basic design.

## Kaypro goes network

The Kaypro Corporation has begun shipping KayNet, a sophisticated method of linking Kaypro and other CP/M computers, allowing the machines to share common databases and resources.

This announcement marks Kaypro's intention to jump into the LAN (local area network) market legitimised recently by IBM. Kaypro's KayNet retails at \$500 (pre-budget) in New Zealand to connect each computer to the system, while IBM charges between \$700 and \$1200 in the USA.

The ideal KayNet has up to 20 Kaypro 2, 2X, 4 or 10 computers in any combination (each with the option of attaching a Printer), while up to 64 computers may be feasible. Disks, files, and printers resident to each computer, are available to every user in the network.

## Electronic postie

LAN: Mail Monitor is now available from Computer Broking Services Ltd. The electronic mail, with office communications, telecommunications and file transfer capabilities, has been combined into one complete system by Corvus Systems.

Its large data capacity supports up to 32,000 letters in transit. It has integrated, screen-oriented letter editor, password secured and automatic user verification to ensure confidentiality, distribution lists and absentee mail delivery. A modem, linking distant networks has automatic dialling and re-dialling when sending mail, and auto-answer for incoming mail. Program or data files can be attached and sent with letters.

The system is run by IBM microcomputers or compatible machines, using Corvus hard disks and back-up facilities along with the Corvus Bank archival device for storing up to 200 million characters of information for quick retrieval. A typical small local network, including one microcomputer, would be priced around \$15,000, tax paid.

## Status deal

The Auckland software house, Bade Draper Associates, has been given independent software vendor status by Data General. The agreement provides promotional and marketing assistance for the UGEN financial management system to run on Data General's range of minicomputer and desktop computer systems.

Software houses participating in the program have direct access to Data General for marketing and technical services.

UGEN, a suite of financial management packages comprising General Ledger, Accounts Payable, and Fixed Asset Accounting modules, is designed for on-line interactive use on a range of hardware extending from a 16-bit microcomputer up to a 32-bit superminicomputer.

The locally-designed software is installed in about 50 sites in New Zealand ranging from local authorities, primary industry, manufacturing, banking and financial services.

# WHO SAID YOU COULDN'T IMPROVE ON PERFECTION?

NOW **stair** 

brings a whole new  
range of printers to  
New Zealand.

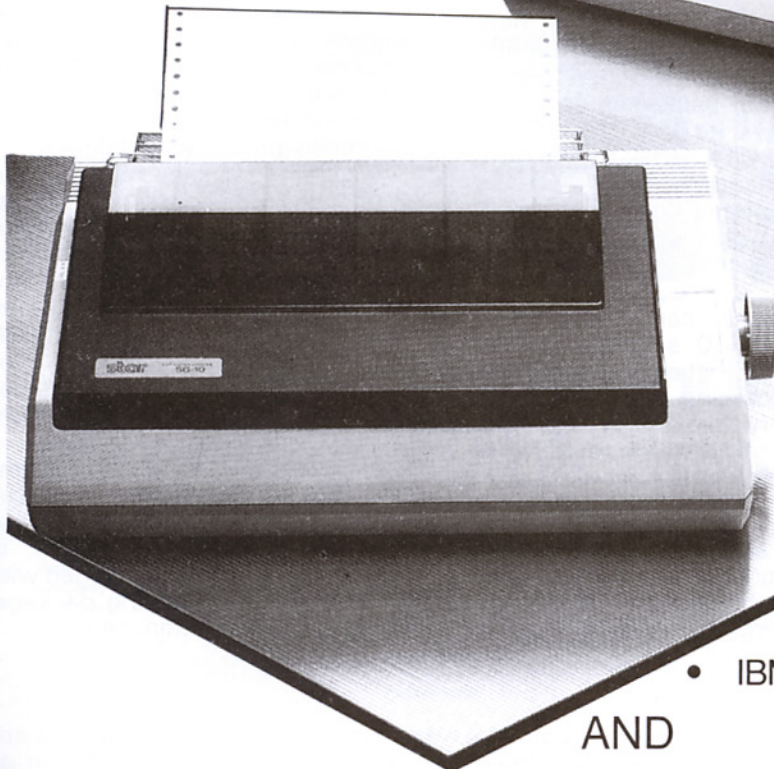
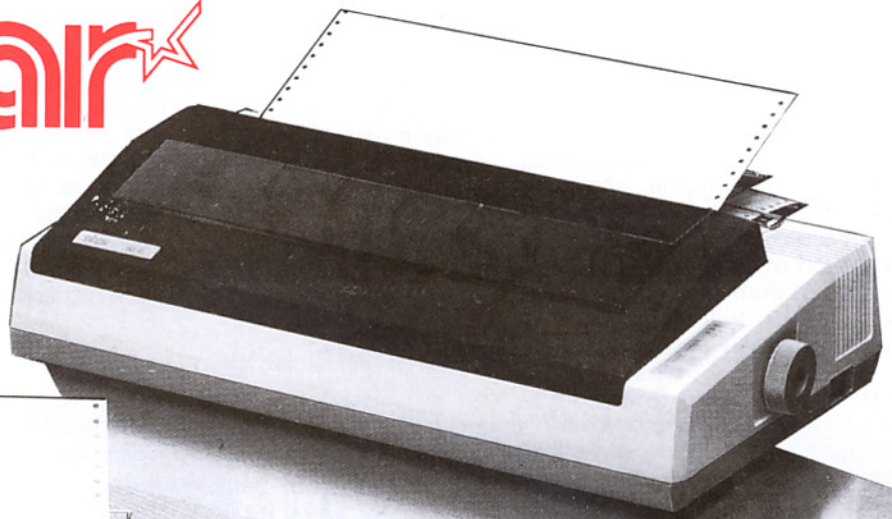

- Near letter quality throughout the range.
- 20% faster throughput.
- IBM compatibility.

AND

at a cost 30% less than our competitors

Before you buy check out **stair**  printers

**You won't be sorry**

**stair** 

**taking the world  
by storm**

Distributed by GENESIS SYSTEMS LTD  
65 Huia Rd, Otahuhu, Auckland  
P.O. Box 6255, Auckland, New Zealand. Telephone 276-7349

17 Service Centres Nationwide.

# Radio computer programs

A Wellington station has become the first New Zealand radio station to broadcast free computer programs, although the techniques has been used overseas and particularly in Britain, for some time.

At 9am every Saturday, program data for "public domain" computer programs is played on Access Radio, 783KHz, so that home computer owners can record the programs for their own use.

Each brand of home computer has its own set of instructions and home computer clubs will take turns to broadcast to their users. Initially, four clubs — Spectravideo, Commodore, BBC and Spectrum — will each broadcast four-weekly. Transmissions will be about three minutes long, containing three or four programs.

Educational programs, games, graphics, and utility programs will be covered, with all contributions to the programme being "public domain" — written by individuals willing to offer them free to other computer users.

## Sperry contract

Sperry has been awarded a contract to supply 1400 personal computers for Queensland secondary school classrooms.

Under the Queensland schools computer literacy project, schools will be supplied with networks of between five and 30 micros. They will be used for general computer awareness through to more complex skills, using software such as spreadsheets, databases and word processing.

## A WYSE family

The New Zealand distributor of California-based Wyse Technology, Rakon Computers of Auckland has introduced the WYSEpc family of personal computers for OEMs. These low-priced micro-computers are IBM PC compatible and feature a compact, ergonomic design.

The WY-1100-1 entry-level system is configured with two 360Kbyte, 5.25 in, double-density floppy disk drives, a 256Kbyte RAM, two serial ports and a parallel printer port. It also includes a 14in, IBM PC-compatible monochrome display that tilts and swivels and a 101-key keyboard. Each system is supplied with both MS-DOS 2.11 and GW-BASIC.

The WY-1100-2 is an IBM PC XT-compatible system with a 10Mbyte

Winchester disk drive instead of one of the floppy disk drives, as well as all the other features of the WY-1100-1.

Both systems are available with a colour graphics option of an ergonomically designed IBM PC-compatible, 14in colour monitor and colour graphics card. Other options include an extended backplane including an additional 256Kbytes of RAM, a real time clock/calendar, battery backup, an expansion chassis with four IBM PC-compatible option slots and a pedestal unit for the display monitor.

## Automatic teller

Burroughs has released a new highspeed, freestanding automatic teller machine for customer use in and away from bank premises. The company says its CA 7100 Quick Cash ATM will appeal to financial institutions, supermarkets, service stations and retail outlets as a low cost way to give customers quick and easy access to their cash accounts.

The machine can complete a withdrawal in 10 seconds — five times faster than competitive systems, according to Burroughs. It has a battery backup system that maintains memory for up to 72 hours following a power failure.

## Computer-run video

The new multi-million dollar Merlin Hotel in Perth, Western Australia, has a 400-room, in-house video

system run by a Commodore 64 computer wired up to three VHS video recorders.

The computer automatically turns the program video tapes on and afterwards, rewinds them ready for the next showing. Between shows, the computer displays a running digital clock showing day, date and time, with a message informing guests of the name and time of the next movie.

The system is claimed to be easily expandable to handle eight video machines.

## Trigger release

"Like having a fulltime management consultant in your computer" that's the claim of Clark Thompson, the New Zealand distributor for Thoughtware, for its latest software release, Trigger.

Trigger is a package for managers to assist in monitoring key business sectors, identifying problems, probable causes and remedial action!

It works by focussing attention on small elements that contribute to profitability and automatically triggers actions based on expectations to established guidelines. It consists of three programs applications disks, a computer-based tutorial on using the disks, and a reference manual that includes case histories and suggested approaches to applications. It comes packaged with a computer-based training package, Managing by Exception.

## MAPAS

Framework Information Systems Ltd feels it gained a major breakthrough in the New Zealand road construction industry with the sale of the management information and project accounting computer system to Emoleum (NZ) Ltd.

Framework, a member of the Paxus group, believes there is a substantial domestic market for the MAPAS software.

Developed in Australia, it is a fully integrated application software system that allows the construction industry to produce management information and costings on individual contracts.

It's encouraging to hear that some commercial enterprises are attempting to address the user education need in the small business market.

Computer advances has launched

the first in a series of courses aimed at small businesses: Selection of a small business system, selection of business software and an introduction to spreadsheeting are covered in the course. Although a Tandy dealer, Computer Advances has tried a non-partisan stance by employing an independent consultant to run the courses. The company believes its Tandy range offers the price and requirements likely to appeal to the small business owner and that it's more important to offer potential customers and users the opportunity to become informed before they make their hardware choice.

More courses are planned, covering word processing and basic computing. A full day course costs \$120.

The Commodore 16 was reviewed in the February issue of Bits and Bytes.

## The learning machine.

The Commodore 16 is the best first time user machine available.

### SUMMARY OF KEY COMMODORE 16 FEATURES

- 16K Random Access Memory (12K user).
- High Resolution Graphics — 121 Colours.
- Powerful Language. Simple Commands like: DRAW, BOX, CIRCLE, PAINT, COLOUR, SOUND and many additional programming treats such as AUTO line numbering, RENUMBER, GETKEY, IF... THEN... ELSE, LOCATE, MONITOR.
- Full Typewriter Keyboard.
- 40 column Screen Display.
- Price \$395.



## The productivity machine.

The Commodore Plus 4 is the only computer with 4 leading software programs built in. Word processing. Graphics. Spreadsheet and File management. With the touch of a key go from one program to another.

Programs that are not only built into the computer, but built into each other.

### SUMMARY OF KEY PLUS 4 FEATURES

- 64K Random Access Memory (60K user).
- Full Typewriter Keyboard.
- Sophisticated Basic Language.
- Built-in Software.
- Split Screen and Windowing Capabilities.
- Price \$895.

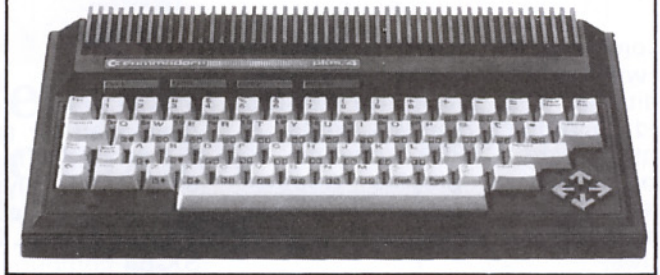

# The new Commodore 16 and Plus 4 are now available anywhere on this page.

- |  |   |   |  |
|--|---|---|--|
| <p><b>KAEO</b><br/>Manco Computer Services. ph. 204</p> <p><b>KERIKERI</b><br/>Errol Rogers Ltd. ph. 78-519</p> <p><b>WHANGAREI</b><br/>Garnet Keene Ltd. ph. 84-999<br/>Muir Electronics Ltd. ph. 82-970<br/>Northland Computer Systems. ph. 83-063.</p> <p><b>KAIKOHE</b><br/>Ian Cook Electronics Ltd. ph. 72</p> <p><b>WAIUKU</b><br/>Simco Electronics Ltd. ph. 59-340</p> <p><b>AUCKLAND</b> ARC Electronix Ltd.,<br/>Papatoetoe. ph. 278-3988.<br/>Ashby Computer Centre, Glendowie.<br/>ph. 588-301.<br/>Ashford Television Ltd., Orakei,<br/>ph. 583-293.<br/>C B Centre, Takapuna. ph. 444-8062.<br/>Computaware Retailers Ltd., Browns Bay.<br/>ph. 478-1793.<br/>Computer Craft, New Lynn. ph. 871-700.<br/>The Computer Terminal, Birkenhead.<br/>ph. 419-0543.<br/>Family Computing Centre, Newmarket.<br/>ph. 540-376.<br/>Glamuzinas, Glendene. ph. 836-9580.<br/>John Walker Music Ltd., Papakura.<br/>ph. 299-8827.<br/>K Road Video and Computer Co., Newton.<br/>ph. 399-655.<br/>Microland, Penrose. ph. 596-450.<br/>Newtons Centre, Henderson. ph. 836-6949.<br/>Personal Computer Store, Takapuna.<br/>ph. 496-502.<br/>Selcom Electronics, Panmure. ph. 577-199.<br/>Supatech Electronics, Mt Eden.<br/>ph. 605-216.</p> <p><b>PUKEKOHE</b><br/>Pukekohe Computers. ph. 87-003.</p> <p><b>THAMES</b><br/>James Electronics Ltd. ph. 86-893.</p> | <p><b>WAIHI</b><br/>Stevens Radio Service Ltd. ph. 8207.</p> <p><b>HAMILTON</b><br/>Computer Rentals. ph. 79-442.<br/>Computer Room Ltd. ph. 80-781.<br/>Dollar Save Comput-a-Centre.<br/>ph. 393-545.<br/>Einstein Scientific Ltd. ph. 81-969.</p> <p><b>CAMBRIDGE</b><br/>Stopwatch Computer Services. ph. 3624.</p> <p><b>ROTORUA</b><br/>Brian Hamilton Ltd. ph. 87-146.<br/>Channel 5. ph. 89-164.<br/>Powercorp Centres Ltd. ph. 479-172.</p> <p><b>TAURANGA</b><br/>Communication House NZ Ltd.<br/>ph. 82-857.<br/>Powercorp Centres Ltd. ph. 81-009.</p> <p><b>TE PUKE</b><br/>Phil Booth Television Audio.<br/>ph. 37-882.</p> <p><b>WHAKATANE</b><br/>Whakatane Appliances Ltd. ph. 85-054.<br/>John C. Good Ltd. ph. 887-611.</p> <p><b>GISBORNE</b><br/>Microtech. ph. 88-990.<br/>Personal and Business Computers.<br/>ph. 88-848.</p> <p><b>HAWKES BAY</b><br/>Andas Centre, Hastings. ph. 82-089.<br/>H.M. Winlove Ltd., Waipukurau.<br/>ph. 88-739.<br/>Timms Business Equipment Ltd.,<br/>Napier. ph. 54-250.</p> <p><b>KAWERAU</b><br/>Dennis Jackson Ltd. ph. 7030.</p> <p><b>TOKOROA</b><br/>Computer Centre. ph. 64-900.</p> <p><b>OTOROHANGA</b><br/>King Country Computing. ph. 8071.</p> | <p><b>NEW PLYMOUTH</b><br/>Einstein Scientific Ltd. ph. 82-858.<br/>Lamberts Ltd. ph. 83-667.<br/>Trio Business Centre Ltd. ph. 88-586.</p> <p><b>WANGANUI</b><br/>Stewart Appliances. ph. 52-700.</p> <p><b>PALMERSTON NORTH</b><br/>Einstein Scientific Ltd. ph. 64-108.<br/>Viscount Electronics Ltd. ph. 86-696.</p> <p><b>PARAPARAUMU</b><br/>Kapiti Independent Business<br/>Machines Ltd.<br/>ph. 87-351.</p> <p><b>MASTERTON</b><br/>Masterton Computer Centre. ph. 89-963.</p> <p><b>WELLINGTON</b><br/>Computer Experience. ph. 736-777.<br/>Dispersed Data Network Conslt.<br/>ph. 697-548.<br/>Einstein Scientific Ltd. ph. 851-055.<br/>Home Entertainment Centre Ltd.<br/>ph. 661-145.<br/>Ice Clear TV Services. ph. 282-475.<br/>L.V. Martin and Son Ltd. ph. 724-356.<br/>The Microshop. ph. 721-902.<br/>Vanvis Stereo and TV Ltd. ph. 856-651.</p> <p><b>BLENHEIM</b><br/>Herkt Home Appliances. ph. 88-999.</p> <p><b>NELSON</b><br/>Personal Computer Systems. ph. 79-362.<br/>Ross and Staig TV Services Ltd.<br/>ph. 80-397.</p> | <p><b>RANGIORA</b><br/>Craw Video Services Ltd. ph. 6200.</p> <p><b>CHRISTCHURCH</b><br/>Computerworld. ph. 61-399.<br/>The Computer Centre. ph. 793-428.<br/>The Computercorpo Ltd. ph. 486-780.<br/>Einstein Scientific Ltd. ph. 66-441.<br/>G.T. Computing ph. 797-811.</p> <p><b>GREYMOOUTH</b><br/>Coast Business Machines. ph. 5264.</p> <p><b>HOKITIKA</b><br/>Graham Electronics Ltd. ph. 384.</p> <p><b>TIMARU</b><br/>Oliff's Business Equipment. ph. 44-241.</p> <p><b>ASHBURTON</b><br/>Smith and Church Electrical Ltd.<br/>ph. 89-019.</p> <p><b>QUEENSTOWN</b><br/>Video Electric. ph. 1368.</p> <p><b>ALEXANDRA</b><br/>Ken France Electronics Ltd. ph. 8021.</p> <p><b>DUNEDIN</b><br/>Eclipse Radio and Computers. ph. 778-102.</p> <p><b>GORE</b><br/>Eastern Southland Computers. ph. 5710.</p> <p><b>INVERCARGILL</b><br/>OES Business Systems Ltd. ph. 84-448.</p> |
|--|---|---|--|

Everywhere you go there's a Commodore.

## Appointments

**Tony Cann** has been appointed corporate accounts manager for IDAPS Computer Science (NZ) Ltd. He was previously a sales consultant for videotex with ICL.

**Peter Davey** former marketing manager for CED Distributors Ltd, has been appointed new business manager at IDAPS Computers Science (NZ) Ltd.

**Mal Thompson** has been appointed marketing manager for CED Ltd, the New Zealand distributor for Apple.

**Peter Hasloch** has been appointed manager of SPL (New Zealand). He joined SPL after four and a half years with ICL New Zealand.

## Computer cropping

Computer technology is teaming up with orchard heaters and other traditional frost preventive devices used to protect Florida's crops. A Control Data CYBER computer is being used to provide weather reports, colour maps and market information to growers through their micros.

Management information which will eventually be available to users will include soil test results, pest management alerts, irrigation timing, marketing reports, pesticide labels, business accounting and analysis, farm growth models and crop histories.

## PCM focus

Memorex Corporation is focussing on the PCM (plug compatible market) storage and communications equipment business. Memorex supplies end-users with a wide range of storage and communications peripherals compatible with IBM systems and is also the main supplier of storage equipment for systems sold by its parent, Burroughs Corporation.

Memorex president Philip Dauber says market assessments show that large IBM computer systems users want more than one vendor.

Burroughs says the new focus will enable Memorex to "pursue even more aggressively the tremendous opportunity that now exists in the PCM business."

## 1000th sale

Proton Electronics Ltd, a Takapuna-based computer company, has sold its 1000th Meridian M-64 business program in New Zealand.

# What is in schools?

There's been a lot of guesswork about the penetration of hardware brands into the school market recently. Statistics compiled by the Education Department on the situation in secondary schools show that BBC and Commodore have increased their share over the past 12 months while the Apple hold has dropped slightly.

## Educational market — secondary statistics

| Make or Model               | Number of Machines |         |       | Number of Schools |         |        |
|-----------------------------|--------------------|---------|-------|-------------------|---------|--------|
|                             | Oct '83            | Oct '84 | % inc | Oct '83           | Oct '84 | % inc  |
| APPLE (Ile, II+)            | 881                | 1289    | 46.3  | 315               | 306     | -0.029 |
| BBC                         | 121                | 561     | 363.6 | 18                | 53      | 194    |
| COMMODORE (64, Pet, Vic 20) | 142                | 403     | 183.8 | 24                | 68      | 183.3  |
| COMMODORE 64 (only)         | —                  | 284     | —     | —                 | 37      | —      |

The locally developed programs, developed for the smaller business, are available for debtors, invoicing and sales analysis, stock, creditors and general ledger and run exclusively on the Commodore 64 and SX-64 computers.

## Engineering seminar

Computer-aided engineering — with emphasis on what can be done in New Zealand for less than \$50,000 — will be the core of a seminar run by Massey University's production technology department from May 27-29.

Sessions will include computer-aided design (CAD) both with high performance microcomputers and with super minis; vision systems for inspection and testing; computer-aided manufacturing (CAM); robotics; data logging (including A/D interfacing); computer-aided printed circuit board design and drilling; and the use of microcomputers for spreadsheet, word processing, database management and "number-crunching" applications.

## New LCD screen

An improved, tilt version of the liquid crystal display (LCD) screen has been released for the Data General/One portable personal computer.

Available as an upgrade for current models, the new LCD optimises screen polarisation improving character-to-screen contrast quality, and improving readability.

A continuous tilt adjustment lets users vary their viewing angle to get the best screen clarity while minimising glare.

Data General/One owners can return

their units to Data General for upgrade or take them to an authorised dealer. Upgrading can normally be done in less than 30 minutes.

## Dick Smith computer range

Dick Smith Electronics has revealed it will be selling computers ranging in price from \$180 to \$7000 from this month.

At the bottom end of range is the Aquarius, released last month, retailing at \$179. Next comes the Commodore 64 which Dick Smith Electronics has sold in Australia since its release. The New Zealand division has only recently concluded an agreement with Commodore Computers to sell it here at \$695 (which is the new retail price for the C64).

Then comes the Apple compatible CAT computer which has been available here for about nine months and now sells at \$1295.

At the top of the line, Dick Smith will be offering the IBM-compatible Olivetti M24 and the portable version the M21.

Every Dick Smith branch in New Zealand will contain a separate "Computer City" section staffed by specialist computer personnel.

## A big brother

A big brother for the VZ200, the VZ300 will be released this month. The VZ300 with a hard keyboard, 16K of RAM (expandable in 64K modules), and one 5.25in disk drive will cost \$795. The 300 is completely software compatible with the 200 giving it a significant software base.

# THE *COMPUTER* EVENT of the year!

If you are in the Computer industry, a Computer user  
or prospective user. . .

You can't afford to miss the New Zealand Computer  
event of the year.

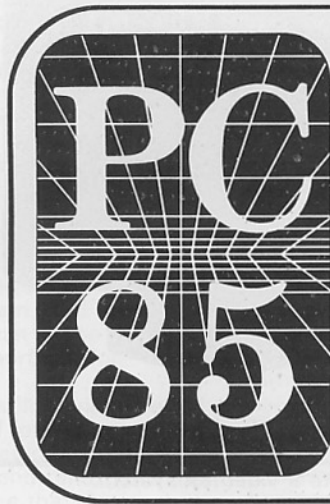

The New Zealand  
**Personal  
Computer  
Exhibition**  
Overseas Terminal  
**Auckland**  
9-10-11 May 1985

**THE** largest Computer exhibition ever seen in New Zealand occupying  
two floors of the Overseas Terminal, bottom of Queen Street,  
Auckland.

**THE** latest Computer Hardware and Software, some of it never before  
seen in New Zealand, will be on display.

**PLUS** lectures, seminars, New Zealand's First Annual Microcomputer  
Dinner, featuring the presentation of the New Zealand  
Microcomputer Software Awards.

*To register for information on the lectures, seminars and Microcomputer Dinner  
please complete and return the coupon below:-*

- Yes I am interested in attending lectures/seminars at PC85. Please send me more information  
on these as they are finalised.  
 Yes I am interested in attending the Dinner. Please send me more information on tickets, etc.

Name .....

Address .....

Return to: PC85 P.O. Box 9870, Newmarket, Auckland.

# Videotex — what is it?

By Nobilangelo Ceramalus

In officialese, Videotex is the generic term agreed on by the International Telegraph and Telephone Consultative Committee (CCITT) for:

information and transaction services exhibiting the following set of characteristics:

1. Information is generally available in textual and pictorial form;
2. Information is stored in a database remote from the user;
3. Information is transmitted between the database and the user by electronic means;
4. Information is displayed on a suitably modified television receiver or other visual display device;
5. Access is under the user's direct or indirect control;
6. Easily operated by the general public as well as by specialist users, i.e., the service is user-friendly.

In short, videotex is to information technology what the Ford T was to the motorcar — a simple system designed to put computer power into the hands of as wide a range of people as possible. In a word, populist.

In case you are confused, videotex is not teletext. Videotex is a two-way communication over a telephone between you, via your terminal, and the central computer (the host). Teletext is a one-way broadcast riding on the back of the normal television signal; you cannot talk back to it. And teletext is limited to a few hundred frames (or screenfuls); videotex has no practical limit to its capacity.

## Computing for people

The most important parts of the CCITT definition are those which talk about television sets, the user's degree of control, and, above all, user-friendliness. These emphasise the populist nature of videotex. Videotex is meant to get away from a concept that is all too current, particularly among those in the "computer industry", that computing is for the chosen, the high-priesthood, an elite few who deal in a remote fashion with the user, or worse, with the "client". (Or, worst of all, with the "prospect".)

Videotex is computing for the little old lady in bare feet, the school pupil, the man in the street — people who want to get on with whatever lives they have chosen to lead, and if a computer can help, good. They do not want to be button-holed by the pin-stripe brigade, then conned by their gobbledy-gook into the never-never land of high-tech where some ever-receding tomorrow will be better, because we, the priesthood, will make it so . . . blah . . . blah . . . blah . . .

Keep it simple stupid. Don't forget that we, the little people, have to live today.



Here's how easy it is to hook into a videotex system.

## History in a nutshell

The first videotex system in the world was developed by British Telecom and called Prestel. The British generic term was viewdata, still used by some who, even now, have not caught up with the internationally adopted term. There have even been those who have rushed into print with convoluted theories that viewdata and videotex are two different animals. Others mis-spell the CCITT word, wrongly putting a "t" on the end. Hiccups in the information revolution . . .? (In the case of *Bits & Bytes*, February 1985, it was a typographical slip — editor).

After the British system, the French and other nations developed systems and claimed to have advanced the software sufficiently to call them second-generation videotex. But too often, so-called progress was more leaps into tech, rather than steps towards people-systems.

Since the only videotex standard to have got anywhere in New Zealand is Prestel, this article is slanted more towards Prestel-aligned systems. The French have yet to persuade us Kiwi-speakers that La Teletel is worth a second look. And the NZPO has not approved the unpronounceable NAPLPS — nah-pilps? nap-lips? whatsit? But whatever it calls itself, with a name like

that it will have difficulty persuading anyone it will have a people-system built on it.

In 1983, British Telecom, in partnership with MicroNet 800, launched the inevitable — a generation of videotex which did away with the need for a special videotex terminal. Instead, they developed terminal software and inexpensive modems for a number of leading microcomputers. Sensible really.

Why should you and I have to go out and buy a dumb videotex terminal (for \$800 to \$3000) which can only sit there looking expensive when we are not receiving videotex? Why not add to the uses of our micro instead? So they did (for \$250 to \$600).

## Telesoftware

At the same time, they added telesoftware — that's what downloading a program over your telephone is called. All they had to do was a bit of a fiddle in the terminal software and a bit of a fiddle at the host end, and programs could be stored and transmitted as videotex, then decoded back into software in the user's micro. It just needed SMOP (small matter of programming).

Of course, you can get a much better videotex service on a micro than a dumb terminal. Even if only because you are more likely to have a decent keyboard.



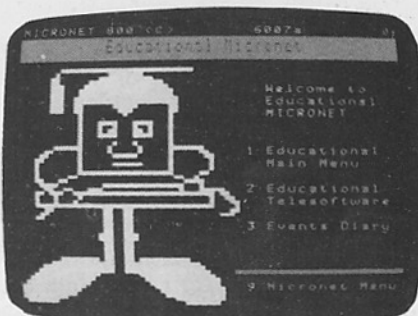
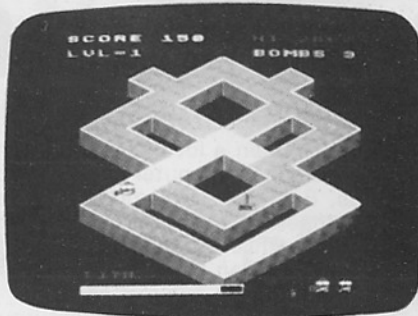

Videotex can be put to many uses . . . including (from left) up-to-the-minute micro news; telesoftware; on-screen games; teach-yourself programming; educational software; swapping hardware, peripherals and ideas.

dumb terminals seem to have been designed by parrots — tiny keys made for hunt-and-peck, hunt-and-peck.

There is also the intelligence of the micro, its enormous storage capacity for copying frames, its flexibility, telesoftware etc. And you save a lot of money — you need only one machine to do your computing and your videotex, not two. And if there is a change in the way videotex works, all your micro needs is a new program; a dumb terminal goes on the tip.

Particularly in New Zealand, we should not be wasting valuable overseas funds on importing dumb terminals when, for the cost of a modem and a bit of software, we can be using microcomputers imported for other reasons anyway.

Lots of people are still buying the old dumb terminals. But if lots of people are still calling videotex viewdata, or spelling it with a "t" on the end, and there are still people who believe that the earth is flat . . . what you can expect?

## The host software

In a word, videotex host software is not much chop.

In the mid-1980s, the purveyors of videotex systems are still expecting people to put up with an information structure held together with Number 8 fencing wire and 10 workers.

To be more precise, but less

interesting, the systems are essentially menu-driven; and all the relationships between the forests of menus, and between the frames, are manually set by the workers at the host end — and manually unset, we hope.

In British Prestel, there are response-frames with which users can advise British Telecom of places where there are no longer places because one of the workers didn't take out a redundant branch on the tree!

But all that menu guff is no good for the afore mentioned little people — us who just want to get on with life. We, rightly, are more interested in the meal than the menu.

So videotex is as yet only half-way there. By using micros, it has got the terminal end right. The host software needs to become really user-friendly. Then videotex will have come home, literally. People will feel at home with it, it will be desirable, it will fit naturally into businesses, schools, homes — like the telephone, designed for people and as flexible as a conversation.

The development in computers and computer communications is the most visible and catalytic change of the century. Now, the combination of the communication-oriented micro-computer, the television set, and the telephone makes it possible to put all the benefits of this revolution into the hands of people at large. That is what videotex is all about. Or should be. Roll on a decent system.

★ IN STOCK! ★

**AMSTRAD**  
ONE GREAT IDEA AFTER ANOTHER

- 64K OF RAM (42K available)
- 32K OF ROM
- Ready-to-go—JUST PLUG IT IN!
- High resolution graphics
- STEREO SOUND 3-voice, 7-octave stereo output fed through a hi-fi amplifier and speakers
- Expanding range of Software
- Unlimited scope for expansion

GREEN SCREEN  
**\$995**



COLOUR SCREEN  
**\$1395**

**DISK DRIVE**  
**\$795**  
**SECOND DISK DRIVE**  
**\$595**

**TOTAL RANGE OF SOFTWARE!**

We have what you need:

- Printer Paper & Pens
- Disks
- Cords, Leads, Etc.
- Everything In Stock!

PHONE OR SEND YOUR ORDER NOW! FREE OVERNIGHT DELIVERY N.Z. WIDE!



**manukau**  
**COMPUTERS**  
LTD.

WRITE FOR OUR COMPLETE PRICE LIST  
(N.Z.)

PHONE AK 656-002

P.O. Box 26-074 AUCKLAND 3  
CORNER MANUKAU & PAH RDS - EPSOM

# Why & wherefore of modems

By Selwyn Arrow

There has been a lot of talk and print lately in personal computer circles about modems. But what is a modem - just another appendage to your computer to be used for a while and then forgotten, or something that can be of long-term use to offset its not too minimal cost?

Until now, only a few adventurous souls have been prepared and able to use this device. But this will change in the coming year as more and more home computer users discover the world of telecomputing poised ready to appear on our computer screens at the touch of a key.

A modem - or to use its proper name, data modem - is an interface or bridge between two different worlds - world of personal computers, and their relationship between user and machine; and the very wide world of the telephone which allows you to call any number of people, or databases, anywhere within reason on our globe.

Every computer communicates internally with binary or two-state (ON/OFF) direct current electrical signals called bits (Binary digiTS), whereas the telephone accepts only continuously varying speech sounds and transmits/receives them as variable electrical signals. This type of signal is easily amplified along the way whereas direct currents are not.

So the data modem, short for MODulator/DEMulator, converts (modulates) the binary data information it receives from your computer onto a limited range of audible sounds in an acoustic coupled modem, leaving the telephone handset to produce electrical

signals just as it does for your own speech patterns. In a direct coupled modem, the binary information is converted directly into variable electrical signals corresponding to those same sounds, and these are sent directly to the line, bypassing the telephone altogether.

Both types of modem do the same job but the direct connect modem cuts out the audio (acoustic) stages of conversion, which makes it less subject to distortion and errors in transmission and reception. And they cannot pick up any background noise as there is no microphone.

## Large price range

There is a large range of prices with both models, depending on the features offered. Acoustic modems vary from kitsets at \$110 upwards, to assembled and tested units from about \$250 up to around \$900. The range of direct connect modems is, to say the least, rather limited, with very few actually having obtained type approval. These are expected to sell for \$700 and more, if you can find them. They should include a lot of functions at that price.

It is easy to see why the kitsets, such as that featured in *Bits & Bytes* February 1985, although illegal to use via the phone, are quite popular! These kitsets, and most likely the newer models as well, use the recently available multi-mode chips which are sometimes available for as low as \$90 each (plus tax). Not exactly cheap but they do away with a lot of design work and fiddling with filters etc. They can provide a

multitude of transmission speeds and even the capability of converse in the North American (Bell) standards rather than the CCITT standards used by the rest of the world.

Their speed can be set to 300bps (bits per second), 600bps or 1200bps. Any faster than this and you will require a dedicated line! At 300bps, it is usual to send and receive signals at the same time. This is known as Full Duplex. Simultaneous two-way communication is possible at this rate because only a small part of the available telephone bandwidth (300Hz to 3400Hz) is needed for each signal. Remember "1"s are represented as one tone and "0"s as another, and two entirely different tones are required in the reverse direction.

Our ears and brain can differentiate between our own voice and the person at the other end of the line but a modem cannot, so each of the two tones in each of the two directions must be quite separate. At faster speeds such as 1200bps, each signal uses more bandwidth as it contains four times as much information. You can then have only one direction of transmission at a time, or Half Duplex.

## The differences

There are several other differences in choosing between acoustic coupled and direct coupled modems for your own use. These include portability, legality, price, range of speeds and, for the moment anyway, availability.

Portability can be a factor if you are likely to take your computer with you to work or school or on your travels. As long as there is a phone handy, you can nearly always use an acoustic coupled modem, although the new style phones with their smaller handsets can sometimes cause difficulties in obtaining a good fit for acoustic cups designed for the older phones.

The problem with taking a direct connect modem with you is that although they are usually much smaller than the acoustic model (no acoustic cups of course), they must have a suitable telephone socket installed to connect to the line.

The acoustic models have no problems with legality of use, as long as they have been set up not to exceed the correct levels (loudness) so that they do not interfere with other telephone users on nearby lines. The only direct connect modems permitted to be connected to the public switched telephone network are those approved or supplied by the New Zealand Post Office for that use. This approval does include kitsets or do-it-yourself models; anyone caught using them is very likely to have them confiscated and perhaps face a fine as well.

It is possible to get type approval for a DIY direct connect modem but obtaining

Coffee in the Keyboard, Thief On the Premises, Fire in the Building. . . .

## DISASTER!!! VERY COSTLY EVENTS

Computer equipment insurance is now easier, more effective and less expensive with the introduction of AMP "Computer Equipment Insurance"

Comprehensive cover — wide protection — flexibility.

An enquiry now costs nothing and could save you a great deal in the future. Return the coupon today and receive full details by return mail, or Phone 2782059 Auckland.

Mike Garner  
AMP Insurance  
P.O. Box 23-514 Hunters Corner.  
Auckland  
Name .....  
Address .....  
.....  
Please send AMP Computer Insurance Information.

# Einstein Scientific and The Computer Experience

## present The Great **RITEMAN PLUS**

### Printer Sale

**SALE PRICE \$695**

**SAVE \$250**

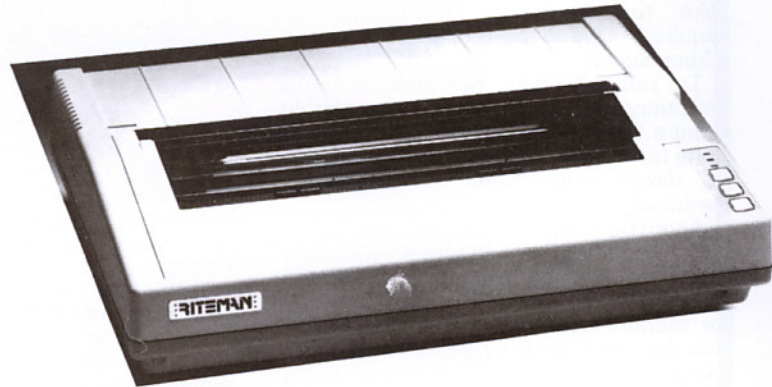

As advertised in 'COMPUTE'S GAZETTE' the 'RITEMAN PLUS' is the choice of people who can't afford to say "Price is no object."

Whether you own a Commodore 64, Atari, Spectravideo, Apple, TRS80 or IBM the RITEMAN is an excellent choice.

At our special sale price of \$695 we ask you to compare the RITEMAN PLUS with other printers that you have considered for your computer.

If you've been looking for a rugged, versatile, dot-matrix printer, you're probably confused by the variety of prices, quality claims and specifications quoted by each manufacturer. When you've narrowed down your choices, here are a few hints to help you decide which printer is best for you.

- How many characters per second will it print?
- Does it run continuous as well as cut sheet?
- Will it print italics, underline, and run in a compressed 132 column mode?
- How much does the ribbon cost?
- How does the price compare with the competition?

Check the features. We think you'll find that there is really no comparison... Riteman. Everything you ever wanted in a printer... for less. We have only 70 printers nationwide at the special price of \$695 and they won't last long at this price. Terms: Cash, Cheque, Bankcard, Visa and H.P. terms are available.

## SPECIFICATIONS

### Print Method

Serial impact dot matrix, 9 x 9.

### Print Head

9 wires (user replaceable).

Print head life expectancy: 100 million characters. A 100% duty cycle (the capability to run continuously).

### Print Speed

Correspondence quality printing 120 cps uni or bi-directional. Logic seeking.

### Graphic Bit Image

Standard horizontal density of 480 dots, double density of 960 dots per line.

### Continuous Underline

You can underline with just one pass of the print head instead of two.

### Paper Feed

- Adjustable snap-on tractor feed (10cm - 25.5cm) (optional).
  - Friction feed (10cm - 25.5cm).
  - Pin platen (24 cm).
- You can use cut sheets, fan fold or pin feed paper.

### Character Set

Full 96-character ASCII with true lower case descenders. 96 italic characters. 32 block graphic characters.

### Printing Mode

- Standard.
- Double Strike.
- Emphasised.
- Double Emphasised.
- Italics.
- Superscripts and Subscripts.
- Expanded.
- Compressed.
- Compressed/expanded.

### Tab

Horizontal tab to 28 positions per line.

### Buffer Size

- 1 line standard.
- in case of pica-80 characters.
- in case of compressed — 132.
- in case of expanded — 40.
- Bit graphics image mode — 480.

### Interface

Centronics 8 bit parallel (standard).

### Serial Interface (Option)

300-900 baud. Easy access to dip switches.

### Ink Ribbon

Reinking compact black ribbon cassette. Easily replaceable and low cost. Ribbon life expectancy: 1,000,000 characters.

**Einstein**  
SCIENTIFIC LTD

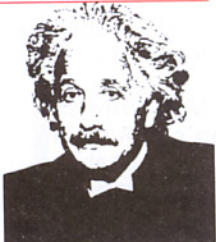

The computer world  
made simple.

EINSTEIN SCIENTIFIC  
177 Willis Street  
WELLINGTON  
Phone 844-353

EINSTEIN SCIENTIFIC  
D.I.C. Store  
Garden Place  
HAMILTON  
Phone 81-969

EINSTEIN SCIENTIFIC  
154 Broadway Avenue  
PALMERSTON NORTH  
Phone 64-108

EINSTEIN SCIENTIFIC  
D.I.C. Store  
Shop 41, 1st Floor  
Cashfields Mall, Cashel St.  
CHRISTCHURCH  
Phone 66-442

EINSTEIN SCIENTIFIC  
Cnr King & Egmont Sts.  
NEW PLYMOUTH  
Phone 85-528

THE COMPUTER EXPERIENCE  
James Smith Store  
Cuba Street  
WELLINGTON  
Phone 736-777



# COMMUNICATIONS

the required certificates for safety standards would be very expensive. Such an undertaking is best left to companies with facilities for manufacturing quantities of modems where they can recoup these expenses over large runs.

## Slower reverse

It is possible to have a much slower reverse signal "tucked in" under the 1200bps signal as is done with the videotex standard. Here, the reverse signal is only 75bps. The directions can usually be swapped so that each end can take turns sending information as required. This is co-ordinated over the 75bps signal.

To run 1200bps or more in both directions at the same time would require two dedicated (fixed) lines as is done for the fixed data network. This has no direct connections to the public switched network.

Acoustic coupled modems are usually limited to 300bps, as the response of the telephone to the highest and lowest tones at higher speeds is not optimised for modem use. Remember, the phone was designed many years ago for human use and our brains are masters at "filling in the information gaps" whereas modems are not. Some acoustic modems can be pushed to 600bps, but this quite often requires the use of sophisticated communications software in your computer to detect errors and automatically request a retransmission of the offending item. This would give an effective transmission rate of less than 600bps.

Direct connect modems which can plug into particular brands of computers, rather than work as a free standing unit, should soon be available. There is already one model available for the Commodore 64 but so far, it is type-approved for 1200/75bps (Teletext) only. Incidentally, as this modem is electrically connected to the computer, it has to be included in the type approval as well.

## Other functions

Other functions which could be performed by a direct connect modem are the ability to change direction and perhaps speed under software control, to automatically dial the required number and perhaps detect busy tone so that it can disconnect and try again later automatically.

It is possible to arrange for such a modem to place a call, send and receive information and then hang up, while you are asleep. This is a common occurrence in USA, taking advantage of the reduced toll rates late at night! These telephone type functions will require approval by the authorities. On the other hand, an auto answer modem, as required by computer databases and bulletin board systems, is apparently not likely to be approved by the Post Office as this is the only means it has of charging for such services - if it is directed to in future.

The final choice of a modem is constrained by most, if not all, these factors. And we have not even breached the subject of how to connect the

modem to your computer and whether you may need to add a serial port to communicate with it. Perhaps more on this another time?

## Modems

A round-up of Post Office type approved modems has not been included in this feature as only a few have so far been type approved.

However, type approval is being sought for a significant number and type-approved modem ranks are expected to swell considerably in the near future.

A number of New Zealand companies

are considering or manufacturing modems. The latest is Proton Electronics, a division of Commodore Computers (NZ), which has announced a modem for the Commodore 64 and SX 64 computers.

A round-up of type approved modems will be included in *Bits & Bytes* as soon as the situation becomes clearer.

## AT & T arrives

American Telephone and Telegraph - AT & T - will be launched in New Zealand this month by the newly appointed New Zealand distributor, Microprocessor Developments Ltd (MDL as it's more commonly known in the industry).

MDL has persuaded postmaster-general Jonathon Hunt to do the honours at the launch - testimony to the huge American corporation's telecommunication strength.

MDL's new projects manager, Ken Eagle, predicts the AT & T 3B range will take an 8-10% share of the New Zealand mini-computer market during the next 12 months.

On the basis that UNIX will dominate the mid-large range of computer operating systems, Eagle says the 3B range is ideally suited to pull off the rapid penetration. AT & T developed UNIX and has customised the chips in its WestingHouse (owned by AT & T) 32000 processor to effectively give them a superior machine, he says.

The New Zealand mini market is not dominated by any one brand at present; the top five places are close, according to recent survey results and the AT & T option has a price advantage over a number of its rivals.

For MDL, there are several elements which make the deal with AT & T a far-reaching venture.

With MDL's heavy investment in research and development to date, it must be encouraging to have the US giant enter into joint development projects. One of the first is the

development of a videotex terminal which will run on either Prestel or NAPLS, the North American system.

This will enable users to have a terminal which will work with databases operating on either system. The prototype for this terminal should be completed this month and be available for scrutiny by June.

Although the relationship between MDL's current activities and the new developments will obviously be close, the AT & T division will operate quite separately. Housed in a separate part of the company's new building, new staff are being employed for both sales and technical support and service. Offices are being opened in Wellington and Christchurch and there's an aggressive hunt on for new staff for the divisions.

## Interacting Mac

Apple Computer is introducing a data communications software package that allows the Macintosh personal computer to interact with mainframe and minicomputers as well as commercial electronic information services.

It provides Macintosh users with access to all information stored on large computers by businesses and universities and is compatible with a variety of communications protocols.

MacTerminal can also run on Lisa 2, 2/5 or 2/10 computers using MacWorks, the Macintosh operating system for the Lisa 2 family.

As with Macintosh, the MacTerminal has a visual user interface, integration between applications, a mouse and the ability to view multiple objects on the screen.

It is integrated with MacWrite and MicroSoft Corporation's Multiplan Spreadsheet program, enabling users to copy and paste between applications, and will also be integrated with future Macintosh applications.

## Mega modem

A couple of errors crept into the Mega modem kit that appeared in our February issue. An error-free copy of the kitset instructions and operating instructions can be obtained free by writing to:

Dick Smith Electronics,  
Private Bag,  
Newmarket,  
Auckland.  
Attention: Maurice Bryham.

# FOR FLOPPY DISKS...



**THINK VERBATIM®**

**THE WORLD'S BIGGEST SELLING FLOPPY DISK**

**VERBATIM NEW ZEALAND LIMITED**

**NOW IN WELLINGTON**

**SERVING NEW ZEALAND BETTER**

Telephone (04) 858-615

P.O. Box 11-591, Wellington

**Verbatim®** 

# Tapping the bulletin boards

By Selwyn Arrow

We have seen a lot of changes in the New Zealand telecomputing scene in the last year. The New Zealand Post Office has opened the door for privately owned direct connect modems; phreakers have started to make themselves a nuisance on at least one bulletin board system (BBS) and several have been caught and dealt with by the authorities; at least one BBS has gone commercial; and this year, more computer bulletin board systems will appear around the country.

But just what is a computer bulletin board system? What does it do and what use is it to you or me?

Like any function performed by a computer, a bulletin board system is a program, or more usually a set of programs. And like many other pieces of software, these programs require some specific peripheral hardware. These include plenty of memory — at least 64K bytes of RAM — and for all but a very limited-use system, tens of megabytes of hard disk storage is essential. Of course, a modem and telephone line are very essential.

Not just any old modem, mind you, but an auto answer modem which must be capable of answering the telephone whenever it rings and connecting the

computer through. It must also be capable of detecting when either the caller or the computer has finished the call, so that it can "hang up" the phone ready for the next caller. These auto answer modems are available only from the Post Office; you cannot provide your own.

## Sophisticated software

A BBS, then, is some sophisticated software that can control the telephone line, provide an answering message, give you (the caller) the choice of which message board you want to look at next, provide the facilities for you to look at any or all messages (downloading), as well as accept incoming messages (uploading). All these messages must be stored in the hard disk so that they are available on request. That's what a BBS is all about — messages.

Imagine a bulletin board on the wall at your local supermarket. Passers-by can stop and read messages and add messages of their own, as well as noting down details and phone numbers to reply to. Now imagine sitting at your computer

and doing the same — with a difference. Messages and programs can be placed on a board for all to see, they can be sent to any individual or even sent to a group so that anyone will find your message in their own mailbox when next they "log in".

Logging in is important as each person using the BBS must be known to the system and to message leavers by his or her own name (or an alias). Typically each BBS user uses his or her own name and an initial — mine would usually be "sarrow". And for security, each user has a password, known only to him or herself. If anybody else dials in and gives someone else's name, they get no further than trying to guess the correct password from the millions of possible alphanumeric combinations.

To make a password easier to remember, it is wise to base it on something only you would know — or better still, on two different things. Don't leave yourself wide open by using a relative's name as was done in War Games! Such names can be found given enough research and don't you believe nobody would bother to try and find out. Some people see this as a challenge not to be missed.

## AT LAST A RELATIONAL DATA BASE PACKAGE FOR APPLE II COMPUTERS

- Audio Learning Cassette included with each package
- No extra cards required
- Available for Apple® IIc & IIe

### COMPARE THE PRICE

|                     |           |
|---------------------|-----------|
| Superbase           | \$385.00  |
| Pfs File and Report | \$550.00  |
| D Base II           | \$1040.00 |

Dealer enquiries welcome.

**Superbase™**  
The complete database

Contact your local Apple Dealer

ONLY  
**\$385.00**

"... a super database from Precision Software... this is one of the best of the lot." (RUN magazine, May 1984)



Please send me  
 More Information  
 Superbase Package

Computersouth  
P.O. Box 22713  
Christchurch.

Cheque/Money Order Enclosed.

# IF YOUR BUSINESS IS OUT OF TOUCH WITH YOU... GET IN TOUCH WITH US

We'll put you in touch with telepaging  
- the simplest, fastest way to keep  
you in touch with your business.

Telepaging is a communications  
service designed specifically to save  
valuable time in locating you -  
whether you're near or far, at an  
airport or golfcourse, even in transit.  
All it involves is a small pocket-sized  
paging receiver which can be  
activated by a telephone call from  
anywhere in New Zealand.

As long as you're in range of the  
radio signal, your paging receiver will  
let you know - with a bleep - that  
someone is trying to reach you.

## Telepaging

It's the easiest, most efficient way for  
you and your business to keep in touch.

So if your business is out of touch  
with you, get in touch with us for  
more information.

Just fill out the coupon below.

Please send me a brochure detailing  
Telepaging so my business and I can stay  
in touch.

Name .....

Address .....

..... Phone .....

Send to Freepost No. 122,  
'Telepaging Service', NZ Post Office  
P O Box 292, Wellington

BB



Telecoms

*Keeping you in touch!*

TC119B

# COMMUNICATIONS

## What you see

After negotiating the "getting in" stage, what happens next depends on which BBS you are working with. Typically, the first item appearing on your screen after a short welcoming message would be: "You have mail". You may have the choice of going on but most likely, a resume of the items in your mailbox will appear:

#1 1 April 85 pcooks Modem article NBG 5  
#2 31 March 85 treasurer Financial report 99

The first item (#1) is the message number used to reference which message to read. The date the message was placed on the BBS follows, then the name of the person placing it. Next comes the title of the message and last, the length of message in lines — very useful, as some messages can fill several screens. It's best to be prepared for this.

Did you notice the messages are in reverse order? The most recent is at the top of the heap so that you don't have to read through all the old messages you may have kept for reference before finding the latest.

There are some problems with this set up which can be found on the public boards where you are likely to read the answers to someone's question (dated today) well before you come to the question itself which was posed last week! When you have read your mail and perhaps answered some of it, you can then check other boards to see what is going on.

Just what is available on a BBS? Here are some of the items I found during a session on the Attache Systems BBS in Auckland earlier this year. If you really get stuck on computer games such as Death Star, Adventureland, Pirates Cove, Voodoo Castle and Thermonuclear War Games, assistance is offered (and requested) on the ENTERTAINMENT board along with a "selection" of Irish jokes. FORSALE offers anything from bikes to TRS-80s while WANTED has a

similar range advertised. Many of the board's contents are obvious from their names such as COMMODORE, CP/MUG, APPLE, VIC, IBM, DEBATE.

My current favourite is PACNET as it contains a lot of information on what is available via the New Zealand Post Office Pacnet system. This includes a lot of information on how to get the best use from it, and transcripts of sessions with overseas services and databases, including The Australian Beginning and Delphi (US). These are being added to all the time.

## Typical message

Here is a typical message from this BBS:

Posted . . . 1 Jan 85 at 12:44 am Msg # 10

From: . . . Kxxxxxx  
To: . . . PACNET, SARROW  
Subject: PRESTEL U.K.

Those of you with 1200/75bps modems can access the Dryden Prestel computer with -023411002002000. The demonstration user numbers are 4444444444 and 4444. There is a page under the Micronet service whereby you may request subscription information and forms. From memory, the sub was £14 a quarter-year.

Other messages on this board included a list of international country and services access codes, down times for the US Dialog database, and even one hopeful person asking for "just a couple of passwords" to overseas databases! He probably hasn't realised such services are all charged for so that anyone foolish enough to give away their own password is giving him free access to their account!

You can find a lot of verbiage in some boards but there are also some real gems. For instance, it's possible to access such a system with only a minimal coms (communications) program that can be typed in from a magazine. You may then find some thoughtful soul has "posted" a sophisticated coms program, all ready to

"download" into your computer, that will provide all the bells and whistles you will ever need.

That's the hidden gotcha not always clear to newcomers. Not only do you need to fork out for a modem to access a BBS, you also need a special program to enable your computer to "talk" to your modem correctly, send your attempts at typing down the line and accept incoming signals from the BBS and print them on your screen. This is sometimes called a dumb terminal program.

An intelligent terminal program can usually do much more. For instance, it should be able to save incoming data in memory rather than let it just scroll off your screen and be lost. This data is then ready for you to edit out the parts you don't need and can then be saved to disk or tape. Conversely, it should allow you to prepare messages or programs in advance so that they can be despatched to the BBS at the touch of a key.

## Other functions

Other functions include being able to change transmission speed (if your modem can also do that), select different communications parameters such as stop bits, parity and word length, enable/disable your printer to allow the printer to be online for incoming messages, kill unwanted files, and exit to your operating system.

One function I miss on my coms program is the ability to enable/disable the data storage buffer after a message has started — I have to stop the message, turn on the buffer, then request the message again. All this within 20 seconds otherwise one BBS is likely to say goodbye and hang up on me. Mind you, that same program allows me to transfer files directly to my word processor or even directly to BASIC (if they are ready to run or save) and vice versa. It is written in machine language especially for my computer and so is quite sophisticated.

It does pay to check around before buying a commercial program as there is quite often something available in the public domain from a local computer club for most types of computers, especially the businesslike and later personal models.

The salient point is that unlike using the telephone directly, a BBS allows you to leave messages etc for any number of recipients to pick up at their leisure. It can even help you make friends with others of similar interests whom you may never have otherwise met.

## Paxus merger

The Paxus Information Services group has acquired the Wellington-based software company, Contract Computer Services Ltd.

The company has been merged with two others in the Paxus group, INCAS Finance Systems and New Zealand Commercial Computing Ltd.

# Teach Yourself

Lotus 1-2-3  
WordStar  
Multiplan  
dBASE II  
MBASIC

and more than 40 others . . .

WITH A.T.I.

TRAINING PROGRAMS

(Available for most popular computers).

Become productive with your new computer and software in the quickest, easiest and most direct manner—A.T.I. Computer Based Training programs. Price \$155.

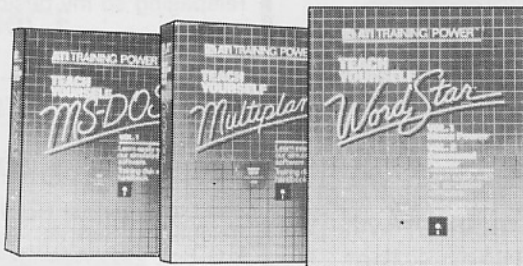

NOW AVAILABLE FROM  
YOUR COMPUTER DEALER

Enquiries and mail orders from:

**TOTAL**  
computer  
services

Authorised  
N.Z. Distributor.

P.O. BOX 1509, DUNEDIN,  
PHONE (024) 773-944



# Am7910 WORLD-CHIP™ — the complete MODEM

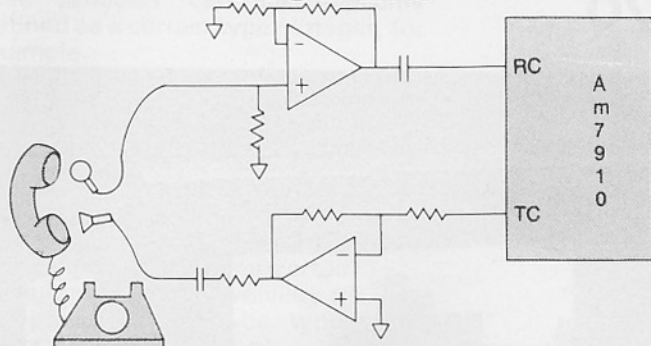

- Complete FSK MODEM in a 28-pin package.
- Meets CCITT V.21, CCITT V.23 plus Bell 103/113 and Bell 202.
- All digital processing eliminates the need for external filters.
- Full range of handshake signals.
- No adjustments, nothing to age or drift.
- Back channel and Auto-answer.
- Loopback for simplified testing.

Very affordable at \$63.00 (plus tax) 10 up,  
available ex stock



## GTS ENGINEERING LTD

52 Broadway, P.O. Box 9613, Newmarket, AK.  
Tel: 546-745, 543-214, Telex: NZ60430  
161 Featherston St, Wellington. P.O. Box 27-357  
Tel: 726-701 Telex: NZ30280

## SEEKING TO PURCHASE OR UPGRADE COMPUTER FACILITIES

For independent, professional consultancy  
service in hardware and software, contact:

**Paul Smith, 3 Condliffe Place,  
Auckland, Ph. 886-378**

### Satisfied customers attest:

"We invested \$400 and saved over \$2000!"  
(Company Secretary)

"I have found Paul to be highly organised  
and reliable with a sound grasp of the  
requirements for successful computer  
systems. . ."

(DP Manager)

"I cannot speak too highly of his courage,  
dedication, organising ability, drive and  
intelligence. . ."

(Administration Manager)

# SEKONIC SPL-400 X·Y PLOTTER

- 6 colour automatic pen change
- On board Centronics interface
- 200mm/sec axial pen speed
- 0.1 mm step size
- 8 directional position keys
- 24 stored plotting commands
- RS 232C & IEEE 488 interface adaptors available

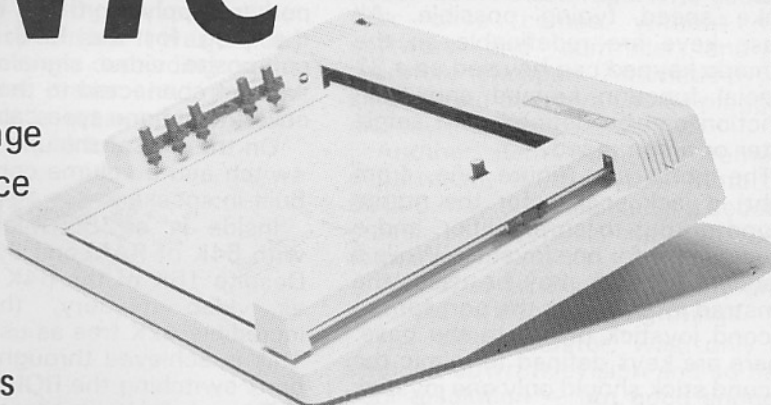

SPL-400: an extremely competitively priced digital X-Y plotter for the  
home enthusiast, draughtsperson or the latest in C.A.D. systems.

SOLE NEW ZEALAND AGENT

DEALER ENQUIRIES WELCOME



E.C. Gough Ltd

Auckland: Phone 763-174  
Wellington: Phone 686-675  
Christchurch: Phone 798-740  
Dunedin: Phone 775-823

ELECTRONICS & INSTRUMENTATION DIVISION

### AMSTRAD CPC464

# Arnold bids for 25%

By Peter Ensor

The manufacturer is hoping to get about 25% of the market with this one, known as Arnold while it was being designed but now called the Amstrad CPC464.

It has been designed as competition to the BBC and Commodore 64 with the main thrust towards the ambitious enthusiast. It is also hoped to attract Spectrum users wanting to upgrade to a more sophisticated computer without too many software changes.

The system comes in two packages. The first is the main computer and cassette, the second the display. There is a choice of two screens — green or RGB colour monitor. Both also contain the power supply so there is only one plug to push into the wall.

A modulator and power supply are also available for use with a standard television set. However this may not be available in New Zealand for a while.

The total package weighs less than 13kg so it is very easy to carry around.

The main keyboard has a good raised keypad for both the QWERTY and the numeric/cursor keypads. The large ENTER key and good key action make speed typing possible. All these keys are redefinable so the numeric keypad can be used as a 32 special function keypad and each function can be defined as a single letter or a command.

The ports are (figure one, from right) a jack socket for the stereo sound output to an amplifier, and a joystick port for one joystick. While a standard joystick may be used, the Amstrad joystick has the port for the second joystick built into the base. There are keys defined to mimic the second stick should only one joystick be available.

Next is a seven-bit Centronics printer port — a bit of a let-down for those with fancy printers or interested in eight-bit graphics characters.

The largest is the floppy disk port which makes available all the signals from the main processor, a Z80, as well as some extra signals such as the light pen and sound.

Up to 240 extra 16K pages of ROM can be attached via this port as well as a floppy disk controller, with each page known by a name by



The Amstrad CPC464

which it is called into use. The onboard RAM and ROM can also be disabled from this port.

The last two plugs are the five-volt power supply from the display and the plug for the RGB, sync and composite video signals. The last two are connected to the display by coiled telephone type cables.

On the side of the unit is an on/off switch and a volume control for the built-in speaker.

Inside is a Z80 microprocessor with 64K of RAM and 32K of ROM. Despite 16K of the 64K being used as video memory, there is an incredible 42K free as user memory. This is achieved through the use of bank switching the ROM.

The built-in cassette, which operates at either 1K or 2K baud, is user selectable on writing but is automatically determined when information is read from the tape. The tape is divided into 2K blocks of information when writing, and there are inter block spaces for stopping and starting the tape.

### Three modes of display

The display has three modes of operation.

The first is 20 characters wide by 25 lines. The graphics resolution is 160 wide by 200 high, all in a choice of 16 of the 27 colours available.

The second mode has 40 characters/320 graphics pixels across but with the same resolution down as the previous mode. This mode operates with only four different colours.

The last mode is 80 characters across by 25 lines, with a graphics resolution of 640 pixels across by the same 200 down. It has a choice of only two colours.

One advantage of the display is that the text and graphics screens are one and the same, so there is no selecting graphics or text screens before using it. In addition, the screen has eight different windows available.

The BASIC, which has been completely rewritten, operates in real time with user-generated interrupts available. These interrupts can come from the timers, the sound generator or through the use of the ESCAPE key.

The BASIC contains the commands to interrupt AFTER a certain time, or EVERY so many milliseconds. The timers can be checked to see how much time

remains. These functions are very good for games program writing.

Another feature of the BASIC is that variables can be implicitly defined as a certain type / integer, for example.

Other commands are the ON ERROR for error trapping and the ON BREAK for closing files — when exiting unnaturally from a program, for example. There is an in-built clock, as expected for a real time operating system, and the PRINT USING statement is supported.

Equivalents involving trig functions can now be worked in either degrees or radians.

## The graphics commands

The graphics commands come with both a relative and an absolute form. The only command missing is the paint command but this may be supplied in a later ROM, according to the rumours.

Any or all the ASCII codes can be redefined with graphics characters.

The sound commands are also fairly comprehensive, and the sound generator is capable of three voices of eight octaves plus white noise.

Both the pitch and the volume can be controlled by envelopes with up to five segments to them. Each segment can be of a definable length and may be of any type. This allows more than just attack-sustain and decay control. For example, two attacks may follow each other.

And each of the sound commands can be placed in a queue so that transfer from one envelope to the next may be made without a break.

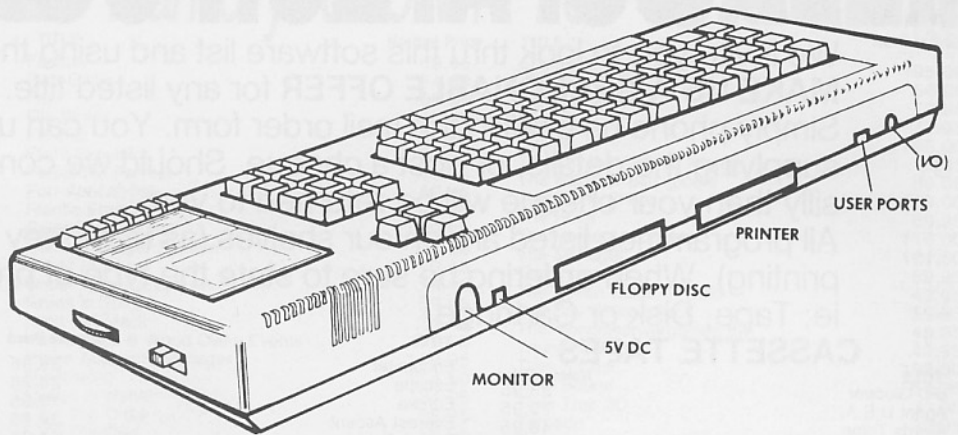

Layout of the ports for the Amstrad CPC464.

These queues also have commands to synchronize each of the voices so that they all end or start together as well as producing interrupts when one of the sound queues has spare space.

Overall, this BASIC runs faster than some of the 16-bit machines (according to published benchmarks) as well as other eight-bit machines. The manufacturer believes it is fast enough to write the games directly into BASIC rather than machine code.

Software support appears to be good with more than 50 titles available when the machine was first unveiled. For those wanting to write in assembler, a Z80 assembler/disassembler is available on cassette.

Documentation with the machine consisted of a 280-page manual that was very easy to read. It was divided into three sections depending on the ability of the reader, had a good glossary and a reasonable explanation about the binary system.

Also available is a firmware specification that goes into depth about the many machine code routines available. No similar technical manual was seen but there are rumours about one existing.

## Looking to the future

As for the future prospects, a RS232 board is talked about, as well as a 3in floppy disk system. A 3in drive rather than the Sony 3.5in was chosen because the Hitachi drives were cheaper and appeared to be just as reliable.

The floppy disk system comes with CP/M 2.2 and LOGO (a teaching/graphics language from Digital Research). Each disk holds about 180K of storage. The second disk drive comes without the software and controller and is therefore cheaper. Alternatively, a single sided 5in drive can be plugged directly into the controller.

Another item from the rumour department is that the Motorola 68000 may be available as a second processor to push up the performance.

Well after all this, there were only a couple of disappointing things.

The RGB monitor was only a stripped down television and so had poor resolution — but good enough for games (business users are best with the green screen).

And the demonstration program didn't really show off the machine. So don't be fooled, have a work-out with it yourself.

From overseas reports, the quality control appears to be excellent and things work properly when released to the public — justification for the manufacturer's hope to capture 25% of the home computing market. The machine is certainly good enough and cheap enough.

## Microcomputer summary

|                                 |  |
|---------------------------------|--|
| <b>Name:</b>                    | Amstrad CPC464.  |
| <b>Manufacturer:</b>            | Made in Korea for Amstrad UK.  |
| <b>Processor:</b>               | Z80.   |
| <b>Clock speed:</b>             | 4MHz.  |
| <b>RAM:</b>                     | 64K.   |
| <b>ROM:</b>                     | 32K.   |
| <b>Input/output:</b>            | Stereo sound, joystick, Centronics printer, Floppy disk, RGB and B/W composite video.  |
| <b>Keyboard:</b>                | Typewriter style QWERTY, numeric & cursor.   |
| <b>Display:</b>                 | 3 modes: 80 by 25 characters; 40 by 25 characters; 20 by 25 characters.  |
| <b>Graphics:</b>                | 3 modes as listed above: 640 by 200 pixels in two colours; 320 by 200 pixels in four colours; 160 by 200 pixels in 16 colours; from a palette of 27 colours. |
| <b>Languages:</b>               | Locomotive BASIC.  |
| <b>Sound:</b>                   | Three voice of eight octave plus white noise.  |
| <b>Cost:</b>                    | With RGB monitor \$1395; with green screen \$995.  |
| <b>Options:</b>                 | Floppy disk with controller, CP/M and LOGO \$795; second disk drive \$550; printer \$695; joystick \$29.95.  |
| <b>Ratings (5 the highest):</b> | Documentation 5; ease of use 5; language 4; expansion 5; value for money 5; support 4.   |

(Review machine supplied by Grandstand Leisure, Auckland).

# It's the SUPATECH COMMODORE

We invite you to look thru this software list and using the listed price as a guide, **MAKE US A REASONABLE OFFER** for any listed title.

Simply phone us or fill in the mail order form. You can use a credit card by just supplying the details, or post a cheque. Should we consider your offer to be too silly then your cheque will be returned to you.

All programmes listed are on our shelves (as least they were at the time of printing). When ordering be sure to state the type of programme you require ie; Tape, Disk or Cartridge.

## CASSETTE TAPES

| TITLE                       | Normal Price | TITLE                         | Normal Price |
|-----------------------------|--------------|-------------------------------|--------------|
| 3-D Gloop                   | 23.95        | Encounter                     | 39.95        |
| Agent U.S.A.                | 79.95        | Escape                        | 24.95        |
| Aliards Tome                | 49.95        | Eureka                        | 79.95        |
| Ambush                      | 24.95        | Everest Ascent                | 39.95        |
| Android 2                   | 39.95        | Falcon Patrol                 | 19.95        |
| Ant Attack                  | 24.95        | Falcon Patrol 11              | 49.95        |
| Antcipital                  | 59.95        | Felix in the Factory          | 39.95        |
| Ape Craze                   | 29.95        | Fighter Pilot                 | 59.95        |
| Aquanaut                    | 49.00        | Final Accounts                | 99.95        |
| Aquaplane                   | 39.95        | Final Flight                  | 65.00        |
| Arcadia                     | 29.95        | Firequest                     | 69.95        |
| Astro Chase                 | 49.95        | Flax                          | 39.95        |
| Attack of the Mutant Camels | 30.00        | Flight 737                    | 29.95        |
| Automania                   | 49.95        | Flight Simulator 747          | 69.95        |
| Aztec Challenge             | 39.95        | Flip and Flop                 | 49.95        |
| Bag it Man                  | 29.95        | Flying Ace                    | 49.95        |
| Balloon Rescue              | 29.95        | Football Manager              | 32.95        |
| Banana Republic             | 24.95        | Forbidden Forrest             | 39.95        |
| Bath time                   | 39.95        | Forestland                    | 25.95        |
| Battle for Midway           | 39.95        | Fort Apocalypse               | 49.95        |
| Battle for Normandy         | 39.95        | Frank                         | 24.95        |
| Battle Through Time         | 39.95        | Fred                          | 24.95        |
| Beach Head                  | 49.95        | Frogger 64                    | 29.95        |
| Beamrider                   | 49.95        | Fun to Learn                  | 39.95        |
| Beyond                      | 24.95        | Galaxy                        | 29.95        |
| Big Ben                     | 39.95        | Games Creator                 | 133.50       |
| Bitmania                    | 29.95        | Gammaron                      | 34.95        |
| Black Hawk                  | 49.95        | Get off my Garden             | 39.95        |
| Blaze                       | 49.95        | Ghost Busters                 | 49.95        |
| Blue Max                    | 39.95        | Ghouls                        | 36.75        |
| Blue Thunder                | 49.95        | Giant's Revenge               | 59.95        |
| Boulder Dash                | 49.95        | Glug Glug                     | 49.95        |
| Bozo's Night Out            | 39.95        | Goblin Towers                 | 23.95        |
| Brenden's Basic             | 0.00         | Graphic Wizard                | 52.95        |
| Bristles                    | 49.95        | Griddler                      | 29.95        |
| Bruce Lee                   | 56.95        | Gridrunner                    | 29.95        |
| Bugblaster                  | 29.95        | Guardian                      | 29.95        |
| Burnin Rubber               | 49.95        | Gumshoe                       | 49.95        |
| Busicalc                    | 90.00        | Gyropod                       | 29.95        |
| Cad Cam                     | 49.95        | H.E.R.O.                      | 49.95        |
| Caesar The Cat              | 59.95        | Havoc                         | 49.95        |
| Candy Bandit                | 64.00        | Heathrow                      | 49.95        |
| Cave Fighter                | 49.95        | Hell Gate                     | 24.95        |
| Cavelon                     | 39.95        | Hexpert                       | 24.95        |
| Centropods                  | 29.95        | Hideous Bill and the Gi-Gants | 19.95        |
| Chilly Willy                | 29.95        | High Noon                     | 49.95        |
| China Miner                 | 49.95        | Hooper                        | 49.95        |
| Chomper Man                 | 29.95        | House Jack Built              | 49.95        |
| Chopper Raid/Distance Demon | 29.95        | Hover Bovver                  | 29.95        |
| Circuits-Switches           | 39.95        | Hunchback 11                  | 49.95        |
| City Attak                  | 29.95        | Hunter                        | 24.95        |
| Classic Adventure           | 39.95        | Hyper Biker                   | 32.95        |
| Colossal Adventure          | 69.95        | Hyperhen                      | 29.95        |
| Combat Leader               | 39.95        | Ice Hunter                    | 29.95        |
| Combat Lynx                 | 59.95        | Inca Treasure                 | 24.95        |
| Contact Bridge              | 29.95        | Indian Attack                 | 24.95        |
| Cops & Robbers              | 39.95        | Introduction to Basic Part 2  | 45.00        |
| Cosmic Capers               | 34.95        | Introduction to Basic-Part 1  | 45.00        |
| Cosmic Commando             | 24.95        | Jack and the Bean Stalk       | 29.95        |
| Cracks of Fire              | 19.95        | Jammin                        | 39.95        |
| Cricket                     | 24.95        | Java Jim                      | 49.95        |
| Crisis Countdown            | 39.95        | Jet Set Willy                 | 49.95        |
| Crossfire                   | 71.95        | Jinn Geniemando               | 49.95        |
| Cup Challenge               | 39.95        | Jump Challenge                | 34.95        |
| Curse of Ra                 | 58.00        | Jumpman                       | 89.95        |
| Cybertron                   | 36.95        | Kick-Off                      | 39.95        |
| Cybertron Mission           | 39.95        | Killer Watt                   | 29.95        |
| Cybotron                    | 39.95        | King Solomon's Mines          | 39.95        |
| Cyclons                     | 29.95        | Kosmic Kanga                  | 39.95        |
| Damsel in Distress          | 29.95        | Krystals of Zong              | 39.95        |
| Daredevil Dennis            | 49.95        | 1-11 Anagram Fun              | 12.95        |
| Dark Dungeons               | 39.95        | Labyrinth                     | 24.95        |
| Death Star                  | 59.95        | Language (Spanish) Course     | 54.95        |
| Decision Maker              | 29.95        | Laser Zone                    | 29.95        |
| Derelect                    | 49.95        | Lazy Jones                    | 49.95        |
| Dicky's Diamonds            | 24.95        | Linkword Language Course      | 54.95        |
| Dictator                    | 39.95        | Loan Analyzer                 | 25.95        |
| Drelbs                      | 39.95        | Lords of Time                 | 49.95        |
| Dungeons of Magdarr         | 49.95        | Magic Micro Mission           | 24.95        |
| Earthquake                  | 39.95        | Magic Stone                   | 39.95        |
| Edumate Light Pen           | 89.95        | Mailing List and Labels       | 39.95        |
| Empire of Karn              | 44.95        | Mangrove                      | 23.95        |
|                             |              | Match Point                   | 69.95        |
|                             |              | Mega Run                      | 39.95        |
|                             |              | Metamorphosis                 | 39.95        |
|                             |              | Microstics 1                  | 24.95        |
|                             |              | Mission 1 Project Volcano     | 79.95        |
|                             |              | Mission Om                    | 34.95        |
|                             |              | Monopoly                      | 29.95        |
|                             |              | Monster Maths                 | 39.95        |
|                             |              | Mothership                    | 49.95        |
|                             |              | Motocross                     | 49.95        |
|                             |              | Motor Mania                   | 44.95        |
|                             |              | Mr Robot & his Robot Factory  | 49.95        |
|                             |              | Murphy                        | 24.95        |
|                             |              | Mychess                       | 59.95        |
|                             |              | Nato Commander                | 39.95        |
|                             |              | Ninja                         | 29.95        |
|                             |              | O'Riley's Mine                | 79.95        |
|                             |              | Odyssey                       | 39.95        |
|                             |              | Orc Attack                    | 32.95        |
|                             |              | P.C. Fuzz                     | 32.95        |
|                             |              | Paddington & Disappearing Ink | 29.95        |
|                             |              | Paddington's Early Visit      | 29.95        |
|                             |              | Paddington's Problem Picture  | 29.95        |
|                             |              | Paint Pic                     | 59.95        |
|                             |              | Pakacuda                      | 39.95        |
|                             |              | Panic                         | 44.95        |
|                             |              | Panic Planet                  | 29.95        |
|                             |              | Panorama                      | 69.95        |
|                             |              | Papermate                     | 89.95        |
|                             |              | Pedro                         | 39.95        |
|                             |              | Personal Data Base            | 89.95        |
|                             |              | Pesky Painter                 | 23.95        |
|                             |              | Pingo                         | 39.95        |
|                             |              | Pipeline                      | 29.95        |
|                             |              | Pitfall 11                    | 32.95        |
|                             |              | Pooyan                        | 39.95        |
|                             |              | Poster Paster                 | 49.95        |
|                             |              | Potty Pidgeon                 | 39.95        |
|                             |              | Practron                      | 49.95        |
|                             |              | Psytron                       | 59.95        |
|                             |              | Purple Turtles                | 24.95        |
|                             |              | Pyjamrama & Automania         | 59.95        |
|                             |              | Pyramid                       | 39.95        |
|                             |              | Quest                         | 39.95        |
|                             |              | Quovadis                      | 89.95        |
|                             |              | Raid Over Moscow              | 69.95        |
|                             |              | Return to Eden                | 44.95        |
|                             |              | Revenge of the Mutant Camels  | 49.95        |
|                             |              | Ring of Power                 | 24.95        |
|                             |              | River Raid                    | 49.95        |
|                             |              | Robbers of the Lost Tomb      | 24.95        |
|                             |              | Scuba Dive                    | 49.95        |
|                             |              | Select 1                      | 24.95        |
|                             |              | Sentinel                      | 39.95        |
|                             |              | Shamus                        | 89.95        |
|                             |              | Sheep in Space                | 29.95        |
|                             |              | Shoot the Rapids              | 39.95        |
|                             |              | Siren City                    | 39.95        |
|                             |              | Snowball                      | 69.95        |
|                             |              | Software Star                 | 39.95        |
|                             |              | Solo Flight                   | 59.95        |
|                             |              | Soooper Froot                 | 24.95        |
|                             |              | Space Sentinel                | 59.95        |
|                             |              | Space Shuttle                 | 69.95        |
|                             |              | Spaceage 2101                 | 34.95        |
|                             |              | Spellbound                    | 64.95        |
|                             |              | Spider and the Fly            | 32.95        |
|                             |              | Spider-Man                    | 39.95        |
|                             |              | Spills & Trills               | 89.95        |
|                             |              | Spirates/Snowmen              | 24.95        |
|                             |              | Spirit of the Stones          | 99.95        |
|                             |              | Spitfire Ace                  | 49.95        |
|                             |              | Spreadsheet (Micro Swift)     | 69.95        |
|                             |              | Spritemaster                  | 69.95        |
|                             |              | Spy Hunter                    | 39.95        |
|                             |              | Spy vs Spy                    | 59.95        |
|                             |              | Squash A Frog                 | 29.95        |
|                             |              | Staff of Karnath              | 59.95        |
|                             |              | Star Battle                   | 59.95        |
|                             |              | Star Command                  | 23.95        |
|                             |              | Star Fighter                  | 59.95        |
|                             |              | Star Trooper                  | 39.95        |
|                             |              | Starbase Defence              | 24.95        |
|                             |              | Starwart                      | 29.95        |



### VIXEN

# Osborne 'out-Osbornes itself'

By Selwyn Arrow

Osborne's latest portable weighs in at only 10kg. On a desk, it occupies just over half the width (325mm) of the original Osbornes and is about three-quarter their overall size. The attached keyboard flips up to cover the screen and a handle is recessed into the left-hand side.

As would be expected from the company that started the rush to provide "bundled" software, Osborne provides nine assorted pieces ranging from business through to screen utilities, and even includes a game.

Sometimes referred to in the adverts as the Osborne 4, the Vixen packs a 128mm (7in diagonal) monitor and two disk drives — double sided double density of course — into the front panel. The 60 keys on the hinge-down keyboard include cursor controls on either side of the space bar and a function key. This is left blank for some reason best known to the manufacturer.

It lacks a numeric keypad, even the ersatz type, as found on most briefcase computers, but a serial routine is incorporated so that a RS232 numeric keypad (or other input device) can be used simultaneously with the keyboard.

The keys have a positive enough feel although they do have quite an amount of side play/wobble. The keyboard is not removable as it hinges down to double as a stand, allowing the front to tilt up by about 90mm to give a readable angle for the screen. This means your eyes must look down nearly double the ergonomic 15-20 degrees from horizontal recommended for comfort.

With a 128mm monitor just beyond your fingers, the viewing distance for the 80 column by 24 line screen is not too hard on the eyes, especially with its easily read 8 x 10 pixel characters. As with the Executive, it is a vast improvement over the Osborne 1 and its tiny 52-column screen.

Alongside the monitor are two vertically mounted half height 5.25in disk drives, each 40-track, double-sided double density and each able to store 390K — equivalent to about 100 pages of text. There are no disk storage slots as on earlier Osbornes; there's simply no room! But several



*The Osborne Vixen*

disks can be safely stored between the screen and the keyboard in its closed position during transport.

### *Three disks provided*

Three disks were provided with the review machine. These included CP/M 2.2 (more about this later); TurnKey to automatically take care of the start-up process; WordStar 3.3 word processor with MailMerge 3.3; SuperCalc2 electronic spreadsheet; Microsoft's MBASIC; Osboard business graphic drawing board; MediaMaster for reading and writing many other disk formats; and Desolation, a game which makes full use of the Vixen's graphic capabilities.

Osborne's implementation of all these can be summed up in just one word — fast! The performance of the business software certainly outpaces most other microcomputers today, including 16-bit machines (see sidebar).

As well as its improved performance, the Vixen is truly very simple for anybody to use. It has a near foolproof auto-start procedure at turn-on and in less than one second, does a complete system test. Skilled or novice, so long as a user can understand the applications provided on the menu (as shown in the accompanying printout), then by typing only one number, it does the rest. No more having to learn the

quirks of CP/M, though the operating system's full facilities are again only one menu command away if required.

Whatsoever, this menu does not need to be reinstalled when new applications are added to the disk; it dynamically adjusts itself to accommodate them. This "turnKey" (turn the key to make it go) system also takes you back to the menu whenever an application is completed. And the menu descriptions are in English, not computerese. For those into that language, it's all done with comments on the first line of each Submit file.

In addition, the keyboard has a full 255 character type ahead buffer (using spare RAM in the 8155 chip) which enables you to queue up characters ahead of the screen display, even while booting up. This does mean you must be careful not to depress any key for too long under these circumstances as the auto-repeat can cause unforeseen problems with multiple commands.

This buffer is also available under program control, enabling characters to be entered as if typed in from the keyboard. For example, your favourite WordStar set-up commands can be placed there automatically whenever that application program is called, to save you entering them each time.

The Osboard graphics package is an electronic drawing board which can be used to draw, edit, save, load or print graphic scenes for use on

graphs, logos, forms, or game layouts. Desolation, a good example of the latter, is actually part of the Rembrandt Business Graphics Toolkit, the remaining components of which are available commercially. It provides 10 graphics characters at a time using the numeric keys. There are 31 different characters to choose from, and all can appear on screen at the same time. A useful set of block commands is also available. Screens of mixed graphics and alphanumerics can be easily added to MBASIC and assembly language programs.

### The gem of the utilities

MediaMaster is, to my mind, the gem of the utilities provided with this computer. With the proliferation of so many different formats for 5.25in disks, this type of program is essential if you want to exchange information with other computers. It may be data for SuperCalc or it may be the latest public domain software, but invariably it is not in your own computer's disk format. MediaMaster to the rescue! It reads, writes and formats (prepares a disk for writing) 26 different formats, including IBM PC-DOS data disks (not programs as they are in 16-bit code). The Vixen can, of course, run only Z80 family programs.

These 26 formats are used by at least 200 different types of computers, from Actrix to Zenith. A very handy utility indeed. Unfortunately, MediaMaster will not look at double-sided disks other than those in Osborne or PC DOS format. A pity!

The Vixen does lack in one other respect — it has only one serial port,

## Two-year gestation

By Selwyn Arrow

For the last two years, there have been rumours in the overseas press over the proposed appearance of the Vixen, or the several other code names for this eight-bit machine.

The original Vixen hardware was finalised in late 1982 and by December of that year, its software system was available as a higher performance Osborne 1. It was due to be launched in USA sometime after the Executive in 1983. But the Vixen project was placed on hold in favour of improving the Executive, then it was cancelled with an IBM PC compatible project about to commence.

Meantime, two Osborne employees began working on the Vixen prototype in their own time. Then in October 1983 disaster struck when the company went through its bankruptcy troubles, from which it is now successfully "trading its way out".

With no development deadlines or production department pressure, the prototype machine's CP/M operating system was completely redesigned over this two-year period to be much faster and simpler to use. Disk access was redesigned, screen writing speeded up, and keyboard scanning is now done in

software. CP/M itself was actually made smaller and faster. Above all, everything was thoroughly tested over a relatively long period well before Vixen went into production.

The final result of this two-year gestation is a dream CP/M system that surpasses even the latest CP/M Plus facilities. Yet all these improvements were made without changing the structure or addresses of CP/M 2.2 by using optimised Z80 code in place of the 8080 code inherited from the original implementation. For instance, one heavily used BDOS (Basic Disk Operating System) routine, a lookup table, now runs 70 microseconds faster. This may not seem much, but when it is used thousands of times, the savings add up to much speedier disk access.

But why go for CP/M when there are now well over 100 US companies joining the rush to IBM PC compatibility? Osborne feels there are too many jumping on that bandwagon and it simply cannot last for much longer. As there are a great many worthwhile CP/M based products available, the newly reorganised Osborne Computer Corporation is backing the Vixen to succeed in the marketplace.

even if that will run at from 50 up to 38.4K bits per second. In this communications age, a modem is becoming close to a necessity and this would use up the one serial port leaving nowhere to plug in the optional serial keypad, printer or whatever. A centronics parallel printer interface is provided at the rear, as is a video out socket for connecting a larger monitor if required. The only other items behind the removable rear panel are the

screen brightness control, power cord and fuse, on/off switch, reset switch, and a small fan. There are no controls or sockets on the front panel.

### The available memory

The memory layout uses 64K RAM with the top 4K shared by both screen RAM and BIOS storage RAM, plus 4K of bank switched system monitor ROM. A hardware "switch" determines which is required and enables either RAM or ROM accordingly. A lot of CP/M's BIOS routines are stored in this ROM instead of taking up valuable RAM space. The 59K CP/M then leaves plenty of RAM available for application programs.

Another aspect that has been improved is the definable function keys. The 10 functions are used by typing "control 0-9" and functions can be nested within each other, ie, one function key can call or even define another, including itself! Functions can be redefined from within a program simply by depressing the function-key-setup key (the blank one), then typing the number and definition of the key.

Documentation supplied consists of four thick A4 ring bound volumes,

SUBMIT FILE MENU

Screen 1 of 2

- 0 CPM EXIT
- 1 BACKUP YOUR SYSTEM (OR APPLICATION PROGRAM) DISK
- 2 PREPARE A FORMATTED DATA DISK
- 3 RUN WORDSTAR (THE WORD PROCESSOR)
- 4 RUN WORDSTAR AND LOG INTO DRIVE "B"
- 5 RUN SUPERCALC2 (THE SPREAD SHEET)
- 6 CREATE A WORDSTAR PROGRAM DISKETTE
- 7 CREATE A SUPERCALC2 PROGRAM DISKETTE
- 8 INSTALL WORDSTAR FOR YOUR PRINTER

SELECT 0 - 8 or A - X, -> NEXT SCREEN, v COM MENU

A sample menu from the Vixen

## HARDWARE REVIEW

weighing in around 2.2kg. As they are not the same small sized typeset volumes supplied with the earlier Osbornes, these may be pre-release copies. Their originals were obviously done on a dot matrix printer — using WordStar I'll bet!

They are certainly comprehensive though. Each is designed as a learn-as-you-go series covering all the software supplied. For the more serious user, more advanced literature would be required. Each has an index and the appendices in volume 2 cover the system specifications in some detail. A technical manual is mentioned as being available but was not included.

I would not like to have to carry the Vixen more than a couple of blocks, and so would have to label it a "luggable" rather than a true

portable. Remember, it does need a power point from which to operate even if it will fit more easily under an airline seat than its predecessors!

After a few hours use, I found I was peering down at the screen. The alternative would be to raise the screen to a higher level, but then the keyboard would be too high! The ergonomics of this machine are not optimum (for me anyway) but that's the price you pay for fixed keyboards on such a portable.

To sum it all up. Osborne has out-Osborned itself by producing a good looking pick-up-and-go computer that outperforms any other. It has supplied plenty of good software at a price that should make many any opposition think twice — further proof that eight-bit CP/M computers are alive, well and progressing.

## Microcomputer summary

|  |  |
|--|--|
| <b>Name:</b>                               | Vixen (Osborne 4).   |
| <b>Manufacturer:</b>                       | Osborne Computer Corporation, USA.   |
| <b>Processor:</b>                          | Z80A.  |
| <b>Clock speed:</b>                        | 4MHz.  |
| <b>RAM:</b>                                | 64K.   |
| <b>ROM:</b>                                | 4K.  |
| <b>Operating System:</b>                   | CP/M 2.2 (enhanced).   |
| <b>Input/output:</b>                       | RS232 serial port; Centronics parallel port; external monitor interface.   |
| <b>Keyboard:</b>                           | 60 keys, including four cursor keys and function key giving access to 255 definable function keys; 255 character type ahead buffer.  |
| <b>Display:</b>                            | 80 column, 24 line, built-in 180mm (7in) amber monitor uses 8 x 10 dot characters; windowing and a 25th line available.              |
| <b>Mass storage:</b>                       | Dual, double density half height 5.25in, 40-track disk drives, 390KB each.   |
| <b>Sound:</b>                              | Inbuilt speaker; beep only.  |
| <b>Graphics:</b>                           | 255, character oriented.   |
| <b>Software:</b>                           | CP/M 2.2, WordStar 3.3, MailMerge 3.3, SuperCalc2, MBASIC 5.21, MediaMaster, TurnKey, Osboard, Desolation, all included in "bundle". |
| <b>Languages:</b>                          | MBASIC, Z80 machine language.  |
| <b>Cost:</b>                               | \$3978, includes all the above software.   |
| <b>Options:</b>                            | External 10MB hard disk with carrying case; external monitor; numeric keypad (serial).   |
| <b>Reviewer's ratings (5 the highest):</b> | Ease of use 5, documentation 4, support 4, expansion 3, value for money 5.   |

(Review machine supplied by Sirius Systems Ltd, Auckland).

## Versatile plotter

Roland DG has begun production of a flat-bed A3 size X-Y plotter compatible with the DXY-800 eight pen plotter. Now available here, it is both IBM PC and Apple compatible and, with drivers available from DG will run Autocad, Lotus 1-2-3, pGraph, BPS, and more.

The plotter will also operate programs written for the HP 7475 and 7475, and has both parallel and serial interfaces on board. It costs \$3000.



**COMPUTERS  
FOR PEOPLE**

**FOR SANYO 550  
SALES AND SUPPORT**

35 Taranaki St, Wellington  
Phone 847-668, 847-628  
69a Rutherford St, Lower Hutt  
Phone 664-069

## XY PLOTTERS

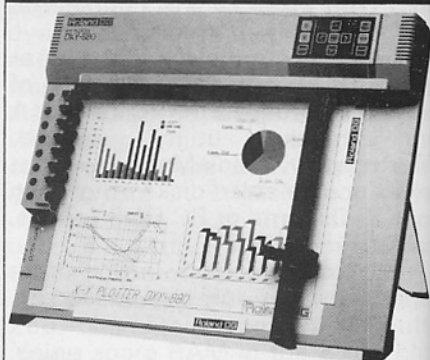

**DXY 980:** eight column plotter with digitizing capability

**DXY 880:** with hi-level graphics

**DXY 800:** user-programmable or run Lotus, Symphony, etc.

**DXY 101:** Single-pen

**FOR**

- ★ Schools
- ★ Business Graphics
- ★ Advanced Hobbyist-Artist
- ★ CAD, CAM
- ★ Professional user

The Roland range covers them all

**Roland DG**  
ROLAND DG CORPORATION

N.Z. Distribution and Service  
**Concord Communications Ltd**  
1 Ngaira Ave, Epsom. Ph (09)  
504-046. P.O. Box 36045,  
Northcote, Auckland 9.



**SANDFLY  
SOFTWARE**

putting the byte back into  
computing!!

**SANDFLY BYTES AGAIN!  
PERSONAL BANKING SYSTEM  
for the ZX81 now only**

**\$19.95**

Dust off the little black machine and put it to work with the most comprehensive banking program around.

Over 10000 PBS Programs sold!  
Send cheque or postal note to:—

**SANDFLY SOFTWARE,  
P.O. BOX 45, TE ANAU.**



# RIGHT PRICE. RIGHT SIZE. RIGHT SPEED. *That's Riteman!*



RITEMAN II

RITEMAN 15

RITEMAN PLUS  
(Tractor feed and cover optional)

RITEMAN BLUE PLUS

If you're looking for an Epson\* or IBM\*\* compatible dot matrix impact printer that's lower in price, smaller, durable, and fast enough to keep pace with your work flow . . . we'd like to show you a Riteman!

Four great new printers. All priced well against comparable Epson models. All substantially smaller. Yet solid as a rock. With print speeds up to 50% faster than the competitors.

The Riteman Plus, Riteman II, Riteman 15, and Riteman Blue Plus with IBM graphics. All are backed by a full one-year warranty. And, as you can see, they're great-looking, too!

For further information contact your local Riteman dealer, or Warburton Franki

\* Epson is a registered trademark of Epson America, Inc.

\*\* IBM is a registered trademark of International Business Machines Corp.

## RITEMAN:

Distributed exclusively in Australia and New Zealand by:



# Warburton Franki

A DIVISION OF THE ANI CORPORATION LTD (INCORPORATED IN N.S.W.)  
 • ADELAIDE (08) 356-7333 • BRISBANE (07) 277-0222 • HOBART (002) 28-0321  
 • MELBOURNE (03) 795-9011 • PERTH (09) 277-7000 • SYDNEY (02) 648-1711  
 • AUCKLAND N.Z. (09) 444-2645 • WELLINGTON N.Z. (04) 69-3016

WF936/81

## HARDWARE REVIEW

### SPERRY PC

# Taste of successful recipe

By Peter Brown

One of the key elements of success in today's market is "IBM compatibility". Any manufacturer who cannot claim at least some degree of compatibility has little chance of making a significant impact.

Recognising this, Sperry Computer Systems has developed a machine which, it claims will run *any* software written for the IBM PC and will support any hardware supported by the IBM.

The Sperry PC comes in seven basic configurations, — each designed to meet different user needs. The most elementary is the Model 20 which comes with monochrome monitor, two 360K floppy disk drives, 128K RAM, parallel and serial interfaces, real-time clock/calendar (with battery backup), and a keyboard with six feet of cord. This comes with MS-DOS 2.11, GWBASIC and some training software.

A Model 50 was supplied for this review. This consists of a single 360K floppy disk drive, 10 Megabyte fixed hard disk, 128K RAM, serial RS-232C interface (parallel interface is optional with this model), real-time clock/calendar (with battery backup), keyboard plus 6ft curly-cord, and a high-resolution (640 x 400 pixels) colour graphics display. MS-DOS 2.11, GWBASIC and training software are standard with all models.

The Sperry Personal Computer is based on a 16-bit 8088 microprocessor with two, switch-selectable clock speeds — 4.77MHz

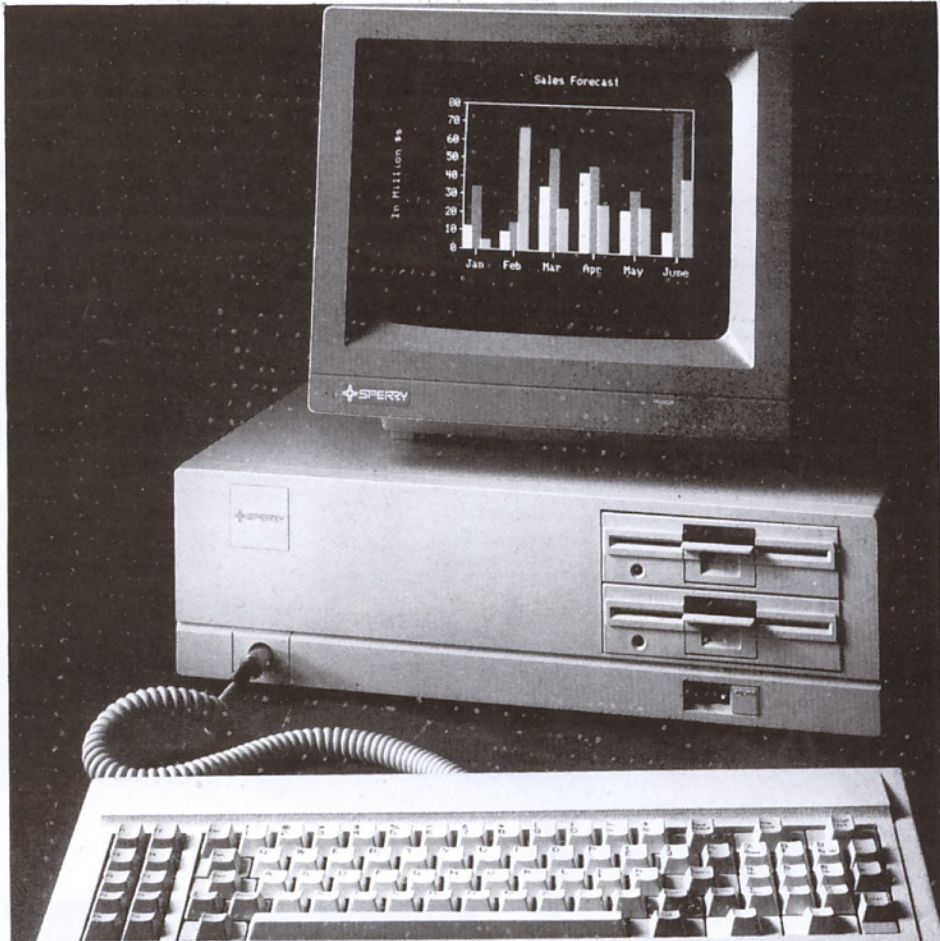

The Sperry Personal Computer

and 16MHz. The basic 128K RAM can

be expanded in 128K steps up to 640K, and the auxiliary storage ranges from two 360K, 5.25in floppy diskettes to one 360K 5.25in floppy diskette plus a 10M fixed disk.

All models have, as standard, asynchronous communications, allowing data rates of up to 9600 bits per second and supporting a range of character formats.

Keyboards are an individual thing and the Sperry keyboard suited me, although it is quite heavy. The 84 keys include a separate numeric pad and 10 programmable function keys. Apart from the weight, it is easy and comfortable to use, and with 6ft of cord (which plugs into the front of the machine), the operator is not forced to sit right up against the monitor.

Sperry's 12in colour/graphics monitor features a high-resolution display of 640 x 400 pixels in its normal mode. However, the colour graphics interface provides the ability to select a resolution of only 320 x

## Microcomputer summary

|                        |  |
|------------------------|--|
| <b>Name:</b>           | Sperry Personal Computer   |
| <b>Manufacturer:</b>   | Sperry Computer Systems  |
| <b>Microprocessor:</b> | 16-bit 8088  |
| <b>Clock Speed:</b>    | Switch selectable between 4.77MHz and 7.16MHz  |
| <b>Memory:</b>         | 128K RAM standard — expandable in 128K steps to 640K.  |
| <b>Keyboard:</b>       | Low-profile keyboard with 84 keys including separate numeric keyboard and 10 programmable function keys  |
| <b>Display:</b>        | Monochrome and range of colour/graphic monitors available. Format is 80 or 40 characters by 25 lines   |
| <b>Languages:</b>      | GW BASIC included as standard with MS-DOS. Other languages also available.   |
| <b>Cost:</b>           | Basic unit (Model 20) \$8100; other configurations range up to \$15,560  |
| <b>Peripherals:</b>    | Standard disk drive arrangements range from two 360K floppy diskettes to one 360K floppy, one 10M fixed disk. Will accept any IBM PC compatible hardware |

### Reviewer's ratings (5 the highest):

Documentation 1; ease of use 3; language 3; expansion 3; value for money 4; support 3.

Review unit supplied by Sperry Computer Systems, Wellington.

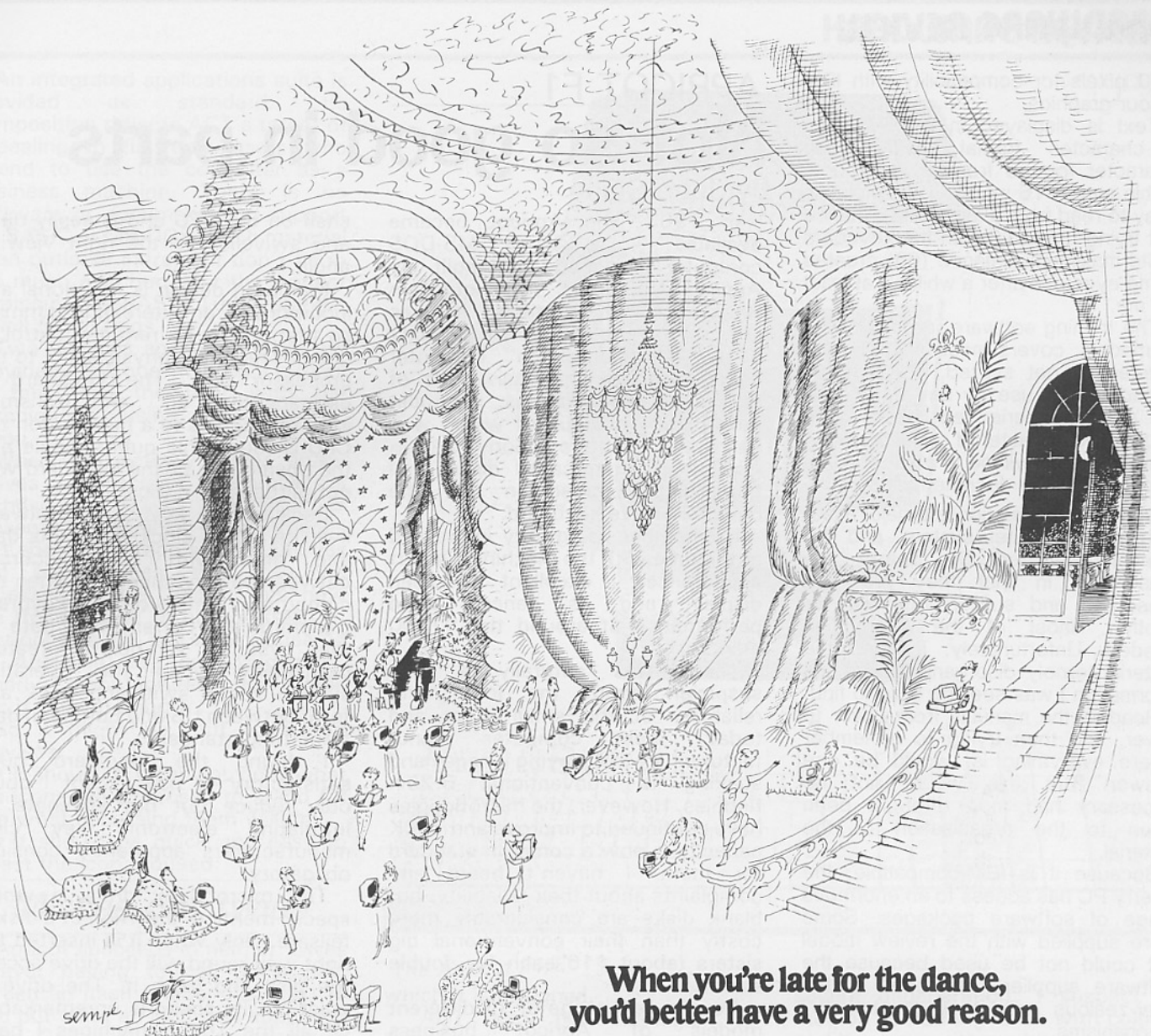

**When you're late for the dance,  
you'd better have a very good reason.**

The party started about three years ago for the personal computer.

And there was dancing.

But there wasn't much talking.

Because as more and more computer companies arrived, there were some very real compatibility problems.

Until one latecomer arrived. Sperry.

With a remarkably simple solution. The Sperry PC.

It was able to run all IBM compatible software.

It was able to run all this software with

stunningly more dramatic graphics and from a substantially more comfortable keyboard than IBM's.

And, with the flick of a special "turbo" switch, the Sperry PC could even run 50% faster than IBM.

Enough for one night? Not for the people from Sperry.

For the Sperry PC had the additional ability to plug into the real brains of an organization—the main computer. Whether that system was IBM or Sperry.

Or both.  
The Sperry PC.

An admittedly attractive arrival.

But when you get there late, you'd better have something important to bring to the party.

Contact Sperry, Greenock House,  
39 The Terrace, Wellington. Phone: 72 1129  
or Sperry, Downtown House,  
Custom Street, Auckland. Phone: 32 772.

© SPERRY Corporation, 1983

**SPERRY**



**The Sperry PC.  
What the personal computer  
should have been in the first place.**

**SPERRY PERSONAL COMPUTER  
SPECIFICATIONS**

|  |   |
|--|---|
| <b>OPERATING SYSTEM</b>                    | <b>AUXILIARY MEMORY</b>                                       |
| MS DOS Version 1.25 or 2.0 with G.W. BASIC | Up to two internal 5 1/4" diskettes                           |
| <b>MICROPROCESSOR</b>                      | 10MB internal fixed disk when configured with single diskette |
| High-Speed 16-bit 8088                     | <b>USER MEMORY</b>  |
| <b>DISPLAY SCREENS</b>                     | Standard 128K bytes, expandable to 640K                       |
| High Definition monochrome display         | <b>DIAGNOSTICS</b>  |
| High resolution color display              | Power-on self test  |
| <b>IBM compatible graphics.</b>            | <b>CLOCK</b>  |
| <b>COMMUNICATIONS</b>                      | Time-of-day with battery back-up                              |
| Built-in Asynchronous                      |   |
| <b>KEYBOARD</b>                            |   |
| 84 keys, 6 ft. cord                        |   |

200 pixels for compatibility with IBM colour graphics.

Text is displayed in a 25-line by 80-character format, with each character formed from 7 x 14 dots within an 8 x 16 matrix. The display is easy to read from a moderate distance but trying to read it with the keyboard at its maximum distance (6ft) created some eyestrain after a while — at least for me.

The training software, provided with all models, covers most of the basics needed to get started, but is a bit superficial for use by any other than the most inexperienced users. Once you have mastered the training programs, you will be in a fair position to cope with the documentation.

Good documentation is a major asset with any computer system, and the manuals supplied by Sperry are reasonable in that they are well presented and supply, one way or another, most of the information needed. Unfortunately, I found the material terribly disorganised and the information I was seeking hard to find.

Reading the manuals from cover to cover, and then trying to remember where everything is, would be one answer. But this would not be necessary had more thought been given to the organisation of the material.

Because it is IBM-compatible, the Sperry PC has access to an enormous range of software packages. Some were supplied with the review model but could not be used because the software suppliers had been a little over-zealous with their "anti-pirate" mechanisms.

The Model 50 can be expanded still further by adding extra memory (up to a maximum of 640K), interfacing it with a variety of printers, plus a range of additional communications interfaces. It will also run any of the hundreds of IBM-compatible peripherals on the market.

With the Sperry PC, Sperry Computer Systems has introduced a well-designed and engineered product in its own right. It has the added advantage of being able to be switched down to run IBM PC compatible software and hardware. And this has been achieved at a price slightly more realistic than most manufacturers offer.

Prices (at the time of writing) ranged from \$8100 (including sales tax) for the Model 20 up to \$15,560 (including sales tax) for the Model 50.

Although I found the documentation disappointing and was not greatly impressed by the training software, in general the Sperry Personal Computer will be a useful addition to the marketplace.

## APRICOT F1

# Not so good in parts

By John Slane

In 1983, the Apricot became available — a 16-bit MS-DOS computer designed and built by Applied Computer Techniques in Britain. At that stage, it was described in the company's publicity as a "4th Generation" computer because of an impressive list of innovative specifications, the most immediately obvious of which was its use of the Sony 3.5in microfloppy hard-cased disks, and the LCD microscreen on the comprehensive keyboard.

I remember being very impressed at the time with the machine's smart appearance, excellent screen display, and its general good performance at around the \$7000 mark.

There was naturally a little suspicion about the long term reliability of the small disks and today, most computer manufacturers are still playing it cagey and sticking to conventional 5.25in floppies. However, the microfloppies have continued to improve and 720K capacity is now a common standard for them. I haven't heard any complaints about their reliability, but blank disks are considerably more costly than their conventional big sisters (about \$16 each for double sided).

Now, a new range of 11 different models of Apricot business computers is being promoted in New Zealand by Barson Computers. These are all Intel 8086 16-bit MS-DOS types. One of them, the F1e, is being promoted specifically as an educational computer — mainly, it seems, because it is supplied with LOGO instead of a business applications package.

The Model F1 comes as the entry point in the business range at just under \$5000 without monitor. The data box shows what you get.

## A lot of style

The styling designers at ACT are to be congratulated. As with the first Apricot, these computers are very distinctive, elegant and pleasing. By contrast, the software engineers don't win any gold stars. But more of that later.

The F1 is quite deep but very narrow, and occupies very little width on an office desk. The monitor perches comfortably on a recessed

shelf on the CPU and is easily tilted and swivelled to the right viewing angle.

Keyboard design is functional and incorporates an interesting gimmick so that, like a TV remote control, it doesn't require a physical link to the processor unit. The keyboard is permanently "on" and transmits infra red signals to a receptor on the CPU. I found this quite reliable and the positioning of the keyboard was not particularly critical.

Because the keyboard is always live, its inbuilt clock maintains date and time with high accuracy between battery changes. When the computer is turned on, the keypress transmits the current time/date to the system. A helpful feature particularly when the operating system keeps switching back and forth between US and European date formatting standards.

I found the keyboard quite satisfactory to use except I could only reduce but not eliminate an infuriating electronic key click manufacturers apparently consider obligatory.

The microfloppy drive is worth special mention. Insertion of a disk is failsafe. Only when it is inserted the right way round will the drive accept the disk and latch it. The drive is quiet but its speed is unremarkable. Of all the 16-bit machines I have tested, only one was slower in writing to and reading from a random file.

## Not so marvellous

The F1 comes with a single double-sided drive with 720K capacity. That's enough capacity for a wide range of uses. It's not so marvellous when it comes to essential backing up of programs and data. Although the processor is provided with 256K of RAM, it doesn't use this very efficiently when it comes to backing up disks or copying files. I counted eight disk changes to one back-up of only 300K.

It could be argued that two disk drives, each 360K, is a more practical configuration than one drive of 720K since copying and backup is a frequent and necessary part of any serious computer use. (I wonder how MacIntosh users would react to that advice!)

An integrated applications suite is provided as standard. Its composition reflects ACT's target of appealing to first-time users who intend to use the computer as a business machine. There is no software or documentation support for BASIC or MS-DOS. Such material is an optional extra, but don't be in too much of a hurry for the Apricot version of GW-BASIC. I understand it is still full of bugs.

Two manuals and three disks are provided. Disk one includes a tutorial to familiarise the user with the technique of using the "activity" menu.

When the activity menu finally arrives on the screen, (the process is surprisingly slow), the user is presented with nicely drawn images and some text representing utilities and programmes that can be accessed. These "icons" are now the trendy thing to have instead of text-only menus, and were pioneered by Apple in Lisa and Macintosh. Clearly, manufacturers now think this is a good thing!

So it might be, but with two provisos:

- It should be clearly obvious what the icons are supposed to stand for and what accessing them will do.
- It should be quick and easy to select the icon required.

## Misses out twice

Apricot succeeds in neither. I was forever having to call up a help screen (in itself a laborious task) to find out what an icon was supposed to do. Generally, the description was brief and appropriate. What a pity I couldn't use the help screen as the menu itself!

The laborious nature of the selection comes about when you don't have or don't use the \$420 "mouse". The cursor has to be slid about all over the screen by using selected keys on the numeric keypad. It's slow and tedious and can't be done without switching your attention to and from the keyboard and screen.

Hewlett Packard does it much better with its "touch screen". A cheaper alternative would be to resurrect the old "light pen" which in its modern version would incorporate one or more select buttons in its handle. There's a free suggestion for ACT!

The applications program includes a very elementary database manager (Superplanner) which although it doesn't allow much creativity, is efficient within the parameters for



## The Apricot F1/E

which it is designed.

"ACT Diary time manager" or something similar, seems an obligatory facility these days. My pocket planner diary (made of paper) leaves this sort of application for dead on the basis of flexibility, ease of access and portability. I have to confess I couldn't work up any enthusiasm to review the ACT electronic version.

However, word processing is a bread-and-butter facility and I was interested to see what the Apricot would offer. The first enormous disappointment was the appallingly bad presentation of text on the screen. I had already noted I would have to make some unfavourable comment about the ugly print font as standard on the F1 Apricot. Then I discovered a font utility that enabled me to design my own characters.

With some satisfaction I created alternative characters to the most illegible ones in the standard font ("m" and "w" were the most urgent to change) but when I switched to "Superwriter", the text suffered a

severe degeneration. I suspect it may be something to do with colour coding but with only the green screen monitor supplied, I can't confirm this.

## Legibility a must

Regardless of how good a word processing program is, if the text isn't easily legible, I have to describe the program as indifferent.

Potentially good features include provision for a wide range of imbedded codes, both for formatting and printing. I was pleased to see the end of line and carriage return symbols (which are just garbage) could be turned off. I was less pleased to find that any change to print parameters was not remembered between edits or printing and had to be reformatted time after time.

A spelling checker of 20,000 words is supplied, but is probably best forgotten. Painfully slow. No immediate presentation of words in context for decisions on action

## HARDWARE REVIEW

(correct, ignore, add to dictionary). Easily the weakest spelling checker I have used.

As with Superwriter, SuperCalc presents fuzzy text and numerals except for row and column labels. This tends to confirm the phenomenon is something to do with being colour capable. Doesn't do intelligent things like recognising labels and numeric input from the first character entered and requires entries to be pre-defined.

I am unable to report on the effectiveness of the ACT sketch program. Although it would load and present the first screen, it wouldn't do anything else even though the latest release notes said it should.

If the Apricot F1 performed as well as it looks, ACT would have a winner. Instead, it suffers from sloppy preparation of software and poor screen presentation of text. In nearly every applications program, things don't work as the screen and the manual indicate. Even the "F1 Starter Pack Supplement" of 14 pages which seeks to correct the glitches in the supplied software is not up to date.

Maybe if the price and specifications of the F1 are attractive, it could be better to abandon the Apricot software and go straight to third party software that meets your need.

Any serious business user will want reliable service from the distributor for both the hardware and the applications programs that run on it. From my experience as a reviewer, I would have to express my concern about the tardiness of Barson Computers in not getting the review unit to me until nearly three weeks after the arranged date. Then, the first unit had a faulty keyboard and an early breakdown in the CPU. The latter was unfortunate, but the keyboard fault could have been found with any cursory predelivery check. Some essential data needed as a prerequisite to writing a review was also slow in arriving.

## Distributor's comment

Barson Computers NZ Ltd's managing director, Doug Pauling, comments on John Slane's review:

It is Barson Computers normal policy to meet reviewers before delivering a unit for review.

This policy was not adhered to in this case, mainly because of lack of resources to provide the equipment

## Microcomputer summary

|                             |   |
|-----------------------------|---|
| <b>Name:</b>                | ACT Apricot F1  |
| <b>Manufacture:</b>         | Applied Computer Techniques (UK) Ltd  |
| <b>Microprocessor:</b>      | Intel 8086 16-bit   |
| <b>Clock speed:</b>         | 4.77Mhz   |
| <b>RAM:</b>                 | 256Kbyte (expandable to 768Kbytes)  |
| <b>ROM:</b>                 | 32Kbytes (boot, and generic BIOS)   |
| <b>Input/output:</b>        | Centronics parallel printer port, (standard); serial RS232C port (standard) for printer and communications. Full function 92-key "soft" keyboard incorporating QWERTY layout, numeric keypad, four machine-specific functions keys and 10 "fixed/general" function keys. Linked to systems unit by infra-red. (Optical light-pipe for use in multi-machine environments, included as standard.) |
| <b>Keyboard:</b>            |   |
| <b>Display:</b>             | Monitor output options: Monochrome/colour 9in or 12in monitor; & composite monochrome monitor   |
| <b>Graphics:</b>            | Text and graphics are not differentiated, there are three selectable modes: 640 x 256 pixel bit-mapped using any four colours from 16 (cf. four grey levels for monochrome monitor); 640 x 200 pixel bit-mapped; 320 x 200 pixel resolution bit-mapped, using up to 16 colour (cf. up to 16 grey shades for monochrome monitor.)  |
| <b>Sound:</b>               | Programmable tone/noise generator and integral loudspeaker.   |
| <b>Price:</b>               | Basic unit, with 256Kbytes RAM, 1 x 720 Kbyte 3.5in disk drive, keyboard, operating system and bundled software, \$4910 (including sales tax); monitor options: 9in monochrome — \$835; 12in hi-res 16-colour RGB monitor — \$1113 plus cable.  |
| <b>Operating system:</b>    | MS-DOS 2.11 (included as standard) CP/M-86, concurrent DOS, UCSD p-system (all optional)  |
| <b>Inclusive software:</b>  | Tutorial (icon/mouse), GSX graphics extensions, Activity (icon/mouse), ACT Diary time manager, ACT Sketch text/graphics pictorial, SuperCalc 1 spreadsheet, SuperWriter Word processor/dictionary, SuperPlanner activity manager.   |
| <b>Peripherals/Options:</b> | 10Mbyte mass storage device; infra-red mouse  |
| <b>RAM expansion:</b>       | 128K, 256K, 384K  |
| <b>Software/languages:</b>  | Wide range of major software and languages as available for MS-DOS, CP/M-86 systems.  |

to the reviewer with various shows and demonstrations running simultaneously.

The reviewed machine was not quality checked. It is unfortunate the keyboard had a sticky key and more unfortunate the CPU developed a faulty relay. Both these faults were not reported immediately to Barson.

It is believed Barson reacted immediately once this information was known.

## MAF picks Apricots

The Ministry of Agriculture and Fisheries has signed a \$500,000 contract with Barson Computers NZ Ltd to supply Apricot computers for its offices throughout the country.

Included in the order is an Apricot Point 32 file server which will run a network of the machines at the ministry's dairy division in Auckland.

This site will be one of the first in the world to run the MS-DOS 4 operating system in a networked environment.

Each computer will include 10 Mbytes of Winchester disk storage in the modern 3.5in size and 512 Kbytes of central

## GWBASIC

The Apricot GWBASIC interpreter has now been "debugged" and will be released for the complete range of Apricot microcomputers on April 1.

GWBASIC will provide the BASIC program access to the Apricot's inbuilt graphics and communications facilities as well as providing a superior screen editor to the normal MSBASIC editor.

memory.

A director of Barson Computers, Graeme Bristow, believes his company won the contract because the Apricots can transfer files to the existing MAF Prime supermini computers and because they offer high resolution graphics and transportability.

Unlike 5.25in Winchester disks, the Apricot xi disks have been designed with transportability in mind. Whenever the Apricot xi is switched off, the disk heads retract the lock, preventing inadvertent damage to the disk surface and enabling the machine to be carried without risk.



# ki microline serial dot matrix printers....

**OKI Serial Dot Matrix Printers can print almost anything  
(with the possible exception of illuminated manuscripts)**

OKI believe that Graphics Capability is no longer a luxury — it's an essential.

In the OKI range of printers, graphics capability is included in all models at no extra cost. Charts, graphs and displays are duplicated at lightning speed but still with the same exacting detail, care and attention that might have gone into an 11th century illuminated book.

The OKI reputation for High Performance and Versatility has made these printers one of the world's biggest sellers.

AWA are proud to be associated with OKI's versatile range of Serial Dot Matrix Printers — the greatest thing in printing in 900 years.

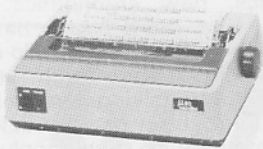

**Microline 80**  
80 cps  
Unidirectional  
80 Column  
132 columns condensed

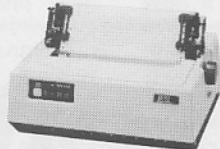

**Microline 92**  
160 cps  
Bidirectional  
80 Column  
Dual Interfaces

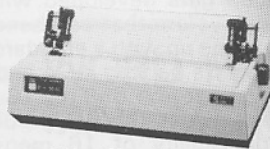

**Microline 93**  
160 cps  
Bidirectional  
136 Column



**OKI 2350**  
350 cps  
Bidirectional  
136 Column  
Two colour printing  
Wide Interface Availability



**OKI 2410**  
350 cps  
Bidirectional  
136 Column  
Two colour  
Technology Intensive.

## OKI

Guaranteed by:

**AWA New Zealand Limited**

For further information contact  
AWA Data Systems Division:

**AUCKLAND**

P.O. Box 1363, Grey Lynn  
Phone: 760-129

**WELLINGTON**

P.O. Box 50248, Porirua  
Phone: 851-279

**CHRISTCHURCH**

P.O. Box 32054  
Phone: 890-449

AWD 2609

# Apple of the future

John MacGibbon concludes his interview with Apple founder Steve Wozniak.

**MacGibbon:** The IIc has the new 65C02 microprocessor and changes in ROM. Will the IIe get these as a retrofit?

**Wozniak:** It would be reasonable to expect it, but I can't guarantee it.

**MacGibbon:** Would such a retrofit make the IIe fully compatible with a IIc?

**Wozniak:** Much more. Until the ROMs are identical they cannot be exactly identical. There's a mouse built into the IIc, and special addresses got assigned to operate it. If you look at it from an engineering point of view, it's hard to imagine that we would go to those extents — or that we could — without messing up the joystick on the IIe. You can never make anything totally identical. Just closer.

**MacGibbon:** So there could be software written for the IIc that will never run on a IIe?

**Wozniak:** I don't think it would be done by Apple. For example, we came out with a mouse card for the IIe at the same time as the IIc was released. And we built in standard entry points for subroutine calls, and we said as long as you use only these entry points the way we document them, it will work on a IIc or a IIe identically.

However, someone outside Apple could work on software products that work on only one of the products. They could do funny calls to operating systems, to undocumented entry points in the ROMs. Then if we ever do a ROM change for improvements, we didn't know about their product and it would possibly not work. We go through that all the time. But the computers are reasonably compatible.

**MacGibbon:** What price would a retrofit be?

**Wozniak:** I don't know. But you could probably make your own estimates though. What you've got to change is pretty much differences in the ROMs: ROMs that are easily replaceable, or we introduce some mouse-text characters in one character generation ROM, we have better 80-column handling firmware and we have some interrupt handling firmware in the monitor ROMs, and its got the 65C02 processor. The total price on five or six chips is not that great.

**MacGibbon:** Surely a lot would depend on what Apple decided to charge for the software contained in those ROMs.

**Wozniak:** Exactly. But we might be trying to ease the whole world for the future, and try to get to one compatible standard rather than two . . .

**MacGibbon:** What built-in memory is the Apple IIe likely to move up to beyond the extended 80-column card's 128K?

**Wozniak:** You would not believe. I'm fighting so hard for them to support many megabytes. In the easiest and cleanest ways, you have to have an



*Steve Wozniak, holding Jesse (2½) and his wife, Candi, holding Sara (three months) at a welcome in New Zealand.*

operating system that supports it. Then you've got to wait a while until applications start getting developed to utilise that much memory. But once an application gets developed with a new operating system that can handle it, we have to come up with a standard for how the memory's banked in — and it might be we just use the 65816, 16-bit 6502 processor. It has the 6502 built-in plus the addressability of 16 megabytes. I think that's the cleanest way.

**MacGibbon:** And that could be put into an existing IIe?

**Wozniak:** It could be plugged into an existing IIe, II Plus or II. As odd as it sounds, we could go back and finally bring our oldest owners up into the world.

**MacGibbon:** Could you put it into a IIc?

**Wozniak:** No. But there are other schemes for adding just memory and modifying applications like Appleworks, to effectively utilise it. Modify LOGO or BASIC or Pascal to utilise more memory.

But the final clean solution that will get all the developers on line is: "Here is a solution for memory addition, here is the appropriate way that we intend to support with an operating system". And then they'll write applications. Say if you have a 64K machine, it uses 64K. If you have a one megabyte machine, it uses all

one megabyte.

**MacGibbon:** Appleworks would certainly benefit from the extra memory. The spreadsheet alone gives you far more cells than memory available to support them.

**Wozniak:** Right. And also the database portion of it. There really are occasions when you want a megabyte or more for keeping a list. It would be so wonderful if Appleworks had a megabyte.

**MacGibbon:** How far into the future are we looking for the Apple II 16-bit development?

**Wozniak:** I can't say. Believe it or not, there's no work going on in our project, no design quite yet. It's getting closer, and I'm pushing for it.

But the funny thing is, we've had designs completed to breadboard stage in the past for that processor. Trouble is, you have to get the right partitioning where everything comes together and makes sense. The computer has to come out very sleek, very high performance. It really has to do the job we want, easily and supportably. You can run up against a bunch of roadblocks, but we're working on some new . . . trying to break through now. Because we want to present in the way that it will be around for five to 10 years.

**MacGibbon:** Could it happen, say within two years, or is it further down the track?

**Wozniak:** No, no, no! If it's further down the track, that's ridiculous once the processor is here.

The trouble is, if we start a new machine from scratch now, we need new plastics, new ergonomics, new everything. You know we'd have to redesign it, do all the software, do all the testing, to get it into high volume production. You're talking a minimum of a year and a half from now for delivery.

If we come up with simpler solutions, just like a plug-in card, that looks like a co-processor, but does some amazing magic things that you don't notice until you use it. That could possibly be done in a time frame approaching eight months starting from scratch.

**MacGibbon:** Just need the decision to do it.

**Wozniak:** Right. And there's pretty much some agreements going on now. We might have hit a good partitioning. I can't talk about specific details, but every once in a while you just click onto something that makes a lot more sense than what you were doing before.

I'm trying to do my best, along with everyone else, to help make the right decisions. Even before, when we had a lot of high performance built into a product with a 16-bit processor, the computer side of me sort of liked a lot of these things, but to the programming



side of me, it just didn't make sense. You know sometimes you've got to give up something, even if it's the neatest processor in the world. If it's not cleanly supportable, in the end, forget it.

**MacGibbon: Has Apple any intention of competing against the low end — the Commodore 64/Atari type computers?**

Wozniak: We try to provide useful products that we feel pay for themselves in the home. And the only way a Commodore or an Atari seems to pay for itself — because of the image of those companies and their products, not the technical capabilities of the products — is in games and entertainment, learning processing and writing a few routines. But those are all entertainment. They're not really used as a business tool in the home.

We tend to sit in a middle ground: the high end of the home, low end of business. We don't have any competition there, if you really think about it. The lower end products below us never really got an image for productivity tools; the higher ones up above us have more capability through technology — the amount of memory for example.

## Dysan/Xidex merger

The Dysan and Xidex Corporations have merged to create one of the world's largest diversified data storage products companies and the No. 2 floppy disk maker.

Dysan will operate as a division of Xidex, retaining its existing manufacturing operations, product lines, marketing organisation and sales force.

Subscribe today

# A 'living piece of history'

**MacGibbon: It's popular to say that the Apple has been expanded far beyond what you had ever conceived. Have you been surprised at the things that have been done with the Apple II?**

Wozniak: Yes, because at first I thought I was some rare person trying to do all these neat things so simply, with a neat elegant machine of my own. Now there are a million people who are that brilliant and doing those things. Everybody who got into our code wound up knowing more about it than I did, even though I wrote it! It's a little shocking to all of a sudden see that I'm nowhere near first class as far as design is concerned. The only thing I've got left is my own style.

When we first came out with the Apple II, we thought that all we'd sell was 4K. That was all anyone ever needed, to learn how to program games in BASIC. That was learning computers. They could run a little colour program that could teach them maths addition on the screen. We figured that in the home it would store recipes and keep track of your cheque book. You know, tasks that are ridiculous for a computer to do. Really. Our first-ever colour ad showed a person working his cheque book in front of the computer.

Oddly enough, we did the floppy disk almost by accident to make that program feasible. It was a personal project of Mike Markkula (Markkula was the first person Wozniak and Steve Jobs added to the team as marketing manager). The cassette tape was too slow, so the floppy disk came about almost by accident.

It turned out the market started going towards business, especially when VisiCalc came out. We got new perceptions: the market told us what it wanted, rather than us guessing. It was

too scattered in the early days. We had no idea where it really would go. And when it finally settled down in a business direction, it was much different than we predicted.

**MacGibbon: In some ways you're regarded as a living piece of Silicon Valley history. The guy who started it all off in the garage. How do you react to that attitude toward you, wherever you go?**

Wozniak: There were a lot of people talking about, you know, little technical freaks, kind of like myself. You know, not businessmen. They were always talking about what you could do with a home computer of your own, but it was always "build it yourself".

I was into slick engineering designs. I know I had a good part of everything. With the Apple II, it was the first time ever for a plastic case, first time ever BASIC went in ROM, first time ever we had 48K bytes of RAM built in, the first time with colour, the first time with graphics, the first time with game paddles and sound. It was like so many things had never been done in a low-cost computer. All built into a small board. So it was radically different from all the computers that preceded it. It set the path for the future.

I played a very technical role, and Steve Jobs played a very important product role, as far as thinking about what we need to build a product for — for thousands of people if not millions.

**MacGibbon: What is your current position at Apple?**

Wozniak: Engineer. Just a logic designer, programmer, whatever comes my way. I pretty much don't have time to actually do any of that yet. But I'm trying to. Even right now, I'm trying to design a board.

I also participate in some lower levels of management within the Apple II

# fulltext

55/80

**WORD PROCESSOR**  
**MAIL MERGE/SORT**  
**SPELLING CHECKER (optional)**  
**ASSEMBLER (6502/65C02)**

 **apple II+**  
**IIe IIc**

- ★ **Announcing.... FULLTEXT 55/80 version 4.**  
**Now even easier to use, even more powerful.**
- ★ **New! The Fulltext integrated Spelling Checker with 45000 word New Zealand dictionary. Add up to 7000 of your own.**
- ★ **The complete word processing system!**

Fulltext 55/80 .....\$125  
Spelling Checker upgrade ... \$55  
Fulltext with Spelling Checker. . \$175

See your Apple dealer or write:

**SPACIFIC SOFTWARE**  
P.O.Box 8035, Dunedin, Tel 738 396

- ★ Requires 64K memory. DOS based.
- ★ Gives 55 characters per line on screen and upper and lower case even on an Apple ][+.
- ★ Uses 80-column card if present to give 80 characters per line.
- ★ Compatible with full //e, //c keyboard. Compensates for missing features of ][+ keyboard.
- ★ Type-ahead buffer. Preview mode. Built-in Mailmerge/Mailsort. Wordsort and concordance. Calculator!
- ★ All menu/prompt-line driven using key-letters (L for Load, E for Edit, F for Find, D for Delete).
- ★ Full word-processing Editor.
- ★ Allows insertion of any control characters in text, giving simple and full control of your printer.
- ★ Advanced formatting options: page numbering, page headings, indentation, justification, definitions auto-indent/auto-numbering of (sub-) sections and (sub-) paragraphs [ 1. 2. 3. etc or a) b) c) etc ].
- ★ Comprehensive 125-page manual with full descriptions. Disk includes SELF-TEACH file for fast learning.
- ★ Simple to learn; powerful to use.

# PEOPLE

division. Pretty much from the level of an owner of the company, some more global perspective than an engineer trying to prove he's clever and can think of a neat thing to add in. Sometimes an engineer loses a bit of common sense because they're not users.

**MacGibbon: You said you are also an Apple fellow. What does that involve?**  
Wozniak: I never got a letter from Apple to tell me officially what it means. I can attend board meetings if I want. I think I

could probably get a budget to work on some independent projects. But I can do that in Apple or at home as much as I wish anyway.

**MacGibbon: What computers do you have in your own home?**

Wozniak: An IBM PC I bought the first week it was out, Breadboards of Apple I's and our early Apple II's. I probably have an Apple II in the house somewhere. I've got an Apple II Plus, a Number of Apple II's and IIcs, a Macintosh, Lisa, the Grid Compass and a Data General One. On my desk at work, I have a Macintosh and an Apple II. Those are really the only two I use.

**MacGibbon: What do you use most?**

Wozniak: An Apple II. You know you get familiar with one, and you just use it for ever. You just want one that does the job satisfactorily and you know why it does it. Computers are not like hi-fis where it's real easy to change.

**MacGibbon: What five disks would you take to a desert island?**

Wozniak: First of all, I would punch holes in the disks to use the back sides. And I would use the back sides as my initial blank disk portion.

I would not take Appleworks if I'm stuck on a desert island. I'd waste a whole disk, and all I could do was keep track of the rest of my software, which after all is only on five disks.

I wouldn't take Pascal because it takes up two disks. I would want some mathematical functions like logarithms,

cosines and sines to help me in my own little mathematical explorations and games, numerical research and the like. I might take MagiCalc to assist me in that. I've already got Applesoft in the computer, right?

I would load up, as tightly as I could, my favourite games onto a couple of disks, using both sides. As many games as I could. I would not waste precious disk resource on long adventure games. Not even on one disk.

I'm sorry. In the end I've got to take Pascal. I've got to take it for development purposes. Or Forth. I'd try somehow to merge in Pascal and Forth, and DOS.

I don't think I'd take Locksmith!

**MacGibbon: Do you play games much?**

Wozniak: No, believe it or not, I'm the sort of person who will get an occasional game and get addicted to it, and I'll play that game heavily for the next two or three years. But I don't take up games very often, because I prefer a game I can get into on a many-month basis.

**MacGibbon: What's your all-time favourite Apple arcade game?**

Wozniak: Choplifter. Dung Beetles was good. Sabotage I loved when it first came out. You shot planes out of the sky back and forth, and I wore every paddle out that I ever got in my hands.

**MacGibbon: Do you play adventure games?**

Wozniak: No. I don't have time. Anything I know is going to take a hundred hours, I don't even bother starting, although at the Olympics I had a two-week vacation and actually did work my way through an adventure game called Secret Agent. It was just about the right timing for my stay there. Of course, I've got a kid too, so I only had a few hours a day to play it.

**MacGibbon: Are you pessimistic about the future in terms of things like nuclear issues?**

Wozniak: Not at all. If I really started to think about the future, I'd think about the past, and I'd say, what has any technology or anything we've ever got in millions of years of existence done for us? And I'd have to say nothing! Nothing!

Are we one bit happier than the guy who lived a million years ago? On the average day, are we happier or sadder? He had as good a life as we have. We just always want to feel that by understanding things we will get happier, but we never do. And not only does our technology create understandings of things, which might make us a little more content, but it creates things like nuclear bombs. But I'm not going to load my mind down.

I decided 15 years ago that anything that was going to lead me into an unhappy life of my own, I didn't want to know about. I read the right books back then, although I don't even remember what they were.

I don't want to wake up every morning with a list of 10 major things that are bothering me. I won't let anything bother me. So I'm one of the happiest people you'll ever find on the planet.

## COMPUTER GAMES FOR HIRE

Games available for weekly hire for the following computers:

★ ATARI ★ APPLE ★ CAT  
★ TRS 80/SYSTEM 80  
★ COM 64 ★ VIC 20 ★ BBC

Send for catalogue and membership details to:

COMPUTER GAME RENTALS  
P.O. BOX 30947, LOWER HUTT.

Name.....

Address.....

Type of Computer.....

## ELMA Miniature Coding Switches

Mounting dimensions

Width 10.16 mm

Height 10.5 mm

Depth 10.35 mm

### NEW TYPE 07

#### Features

BCD- and hexadecimal coded  
Shorting or non shorting switch mode  
Mountable in horizontal or vertical position  
Row mountable in pitch  
Operation by screw driver or stainless steel spindle (knob)  
Sealed and washable  
Solid terminals (0.4 x 0.7 mm)  
Rotation with positive detent setting

#### Life

10 000 switching cycles

#### Terminations

for direct mounting on circuit boards;  
2.54 mm (0.1") pitch

#### Mechanism indexing

36° = 10 positions (BCD)  
22°30' = 16 positions (hexadecimal)

If you are designing digital "gadgets" we have numerous types of BCD & coded switches

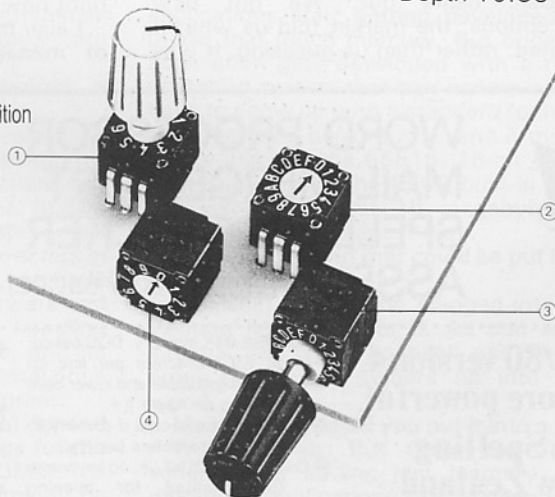

- ① Vertical with spindle
- ② Vertical without spindle
- ③ Horizontal with spindle
- ④ Horizontal without spindle

For further information send to:

**S.D. MANDENO ELECTRONIC EQUIPMENT CO.**

10 WOODHALL ROAD, EPSOM, AK 3. PH 600-008. TELEGRAMS "NUCLEONIC"

*This is the last article in a series on integrated software products. Previous articles have reviewed the fundamentals of integration and looked at particular products. Visi On, Symphony and Framework have already been reviewed, and this month, we review Open Access and present a comparative chart for all four products.*

# Open Access makes a foursome

By John J. Vargo

Open Access is an integrated product from Software Products International, incorporating the application modules most desirable in the business world. Although an integrated product in the sense of common menu structure and data interchange between modules, Open Access does not use interactive windows. It uses windows as a basis for menu display and special feature access only. Standard features of the product include: full use of colour; virtual memory; only 192K RAM required; three-dimensional graphics; time management module; word processor; spreadsheet; full featured database; business graphics. Open Access includes all these in the basic package, requiring no add-ons or upgrades to achieve all functions.

Billed as an integrated product, Open Access has a number of useful integrating features. These include: use of similar menus for the different applications; a help window available from any module; a search window allowing easy selection of needed files; transfer of data between modules or with 'outside' programs; a calculator window for simple calculations within any module.

## *The working environment*

The working environment uses a number of different windows for different purposes. Generally, the windows will appear in the same place on the screen each time you invoke the required feature. For example, the "calculator window", which allows you to use an on-screen electronic calculator whenever you need one, always appears in the upper left corner of the screen and is always the same size.

The non-interactive nature of "windows"

differentiates this product quite significantly from all of the products previously reviewed in this series. A significant outcome of this approach to windowing is the inability to view more than one application at a time within Open Access.

When first entering Open Access, you select the application you would like to work with. The application then loads from disk and you are presented with that application and its associated menus. Files (to modify, create or delete) are selected using the search lists feature which displays a menu allowing you to scroll through the files available on your current data disk. Once you have the required file and application, it is possible to transfer data between applications and also transfer control to a new application.

For example, if you wished to search a database for certain records and then analyse those records, it would be possible to use the information manager module, then transfer the selected records to the spreadsheet module. By selecting the context option, the data as well as control is transferred to a spreadsheet which appears on screen ready for you to use. On the other hand, if the context option is not selected, that data may be transferred to a spreadsheet, but you would continue to work in your original database.

## *The "macro" procedures*

This package allows the creation of automated procedures (often referred to as "macros") which save you having to go through the same procedure over and over again. For example, if you were using the communications module to regularly log onto a network, give your identification

code, acknowledge a response etc, it would be possible to record this whole process as a macro. By the invocation of the macro through the use of the macro key (special function key), specifying the macro file name followed by execution of the macro, the procedure would be automatically carried out.

The use of macros in Open Access can be a bit tricky. You must record the macro from beginning to end without a mistake, otherwise you have to do it all over again. And when preparing to execute a macro, you must be at the exact point including cursor placement, environment settings etc. that existed when the macro was first recorded. In spite of these idiosyncracies, the macro feature is very worthwhile and a real timesaver on repetitive jobs.

The hardware requirements are quite minimal compared with many similar integrated products. A dual disk IBM-PC (or direct compatible) with 192K of RAM, and you are ready to start. Because the program uses a virtual memory scheme, any extra memory is not used directly. Certainly, performance benefits may be derived by use of larger memory with a portion of it set up as a RAM. As this package uses colour extensively in its displays, a colour monitor would be a real plus if you like colour (and who doesn't). But it will run with a monochrome screen.

## **Word-processing**

Word processing is a key application in any integrated product and Open Access does well in this area supporting the usual features — left, right, or centre justification; bold, italic, and underline print; copy text from another file; headings, trailers, page numbering; text search and replace.

As the search function of the word processor does forward searches only, it is

# P. C. POWER LTD.

## Personal Computer IBM Software Specialists!

Importers and Suppliers of:

- NASHUA floppy disks
- OPEN ACCESS

D BASE III, LOTUS 1 2 3, Symphony, FRAME WORK, Flight Simulator, CONDOR

For **FREE** monthly COMPUTER PRODUCTS NEWSLETTER

Name .....

Address .....

Phone ..... Computer Type .....

TELEPHONE (04) 693-050 420 High Street, Lower Hutt.

## SOFTWARE REVIEW

important to place your cursor at the beginning of the file to be searched before executing the search. Searching is allowed for whole words as well as partial words, but "wild card" characters are not supported. Copying of text and moving of blocks of text are accomplished easily, just by following the on-screen prompts.

One of the more interesting features of this word processor is the ability to assign characteristics to a series of paragraph types. Margin settings, justification word wrap and indentation may all be pre-established for up to eight different paragraph types. You can then invoke a particular style of paragraph as you need it through your document.

Naturally, the word processor will communicate directly with the information manager (database) to produce form letters and the like.

## Spreadsheet

Electronic spreadsheets, as originally introduced by VisiCalc five years ago, were a tremendous "invention". This type of productivity tool has matured, as many "visi-clones" have been introduced with many new features. The Open Access spreadsheet has all of the usual features you would expect from a good spreadsheet including: formula replication; block move and copy; built-in financial functions including internal rate of return; table search and lookup function; inter-model referencing; sorting of data.

This spreadsheet also has a feature unusual for a micro-computer spreadsheet (although often found on mainframe financial modeling packages). This is "goal seeking" which allows the user to automate

the process of trial and error when modifying variable values to determine an end solution. By choosing the goal seeking option, you are led through a series of steps which allow you to specify the dependent variable(s), the target value, and the independent variable(s). The computer will then run through five iterations (more if you request more) and determine the closest values for the independent variable(s) to achieve the target value of the dependent variables.

This may sound a bit complicated and a short illustration will clarify it. You have a model which specified sales, cost of sales, expenses and profit. What level of sales would be required to achieve a profit of \$500? Once you have your spreadsheet set up, you would normally try different values until you reach your target profit. With goal seeking, the program itself will try out different values, some higher and some lower, bracketing the target until the difference approaches zero — the point at which you have reached your target — and you know what level of sales is required for a given level of profit.

This concept can be extended to explore a change in the cost of sales level in conjunction with a change in the sales level to achieve a particular profit. In this case, you have one dependent variable (profit) which "depends" on changes in the two independent variables (sales and cost of sales) for its final (target) value.

This is a useful feature in many problem solutions. Some other spreadsheets have a feature which accomplishes much the same function, often called the "iteration" function (as in Lotus 1-2-3), and other products which have a built-in programming language (like Framework) could use a looping structure to achieve a similar result.

## Database processing

Most integrated products are built around a key feature (Symphony on the spreadsheet and Framework on its wordprocessor). Open Access has the information manager (or database manager) as its strong point.

This module is built on the relational model, and is a true database manager (as opposed to an electronic file card system). One of the more interesting features is the information retrieval system. A query language derived from the IBM mainframe SQL language is used — a blessing or a curse depending on your opinion of SQL. The query language allows ready access to the data in your database using four primary terms — FROM, WHERE, SELECT and ORDER. It is possible to have up to 32,000 records per file since the program uses a virtual memory scheme, and may have up to five files open at one time.

Pass Bits & Bytes  
to a friend

## OPEN ACCESS™ It's 6 in One or a Half Dozen of the Others.

Open Access™ breaks the software price barrier. \$1250 This super program can perform virtually every managerial or business task you're ever likely to encounter. You could buy at many times the price, 6 individual non-integrated programs, but why bother when you can have Open Access™?



LEADING EDGE

LEADING EDGE  
WORD PROCESSING™

\$740



Tallgrass  
Technologies  
Corporation

Hard discs  
and tapes  
12-70 meg.

**IRMA** — 8 unique commercial products  
linking micros to mainframes.



Summagraphics®  
CORPORATION

Digitizers

All of these fine products are supported in NZ by:

**THE  
MICRO  
SOURCE LTD**

3 BYRON AVENUE,  
TAKAPUNA,  
AUCKLAND 10.  
TELEPHONE 496-445  
P.O. BOX 33797,  
TAKAPUNA.

**NOW AVAILABLE  
IN NEW ZEALAND**

**From  
this**



**to this**

**Nobody puts  
ideas on paper  
so many ways.**

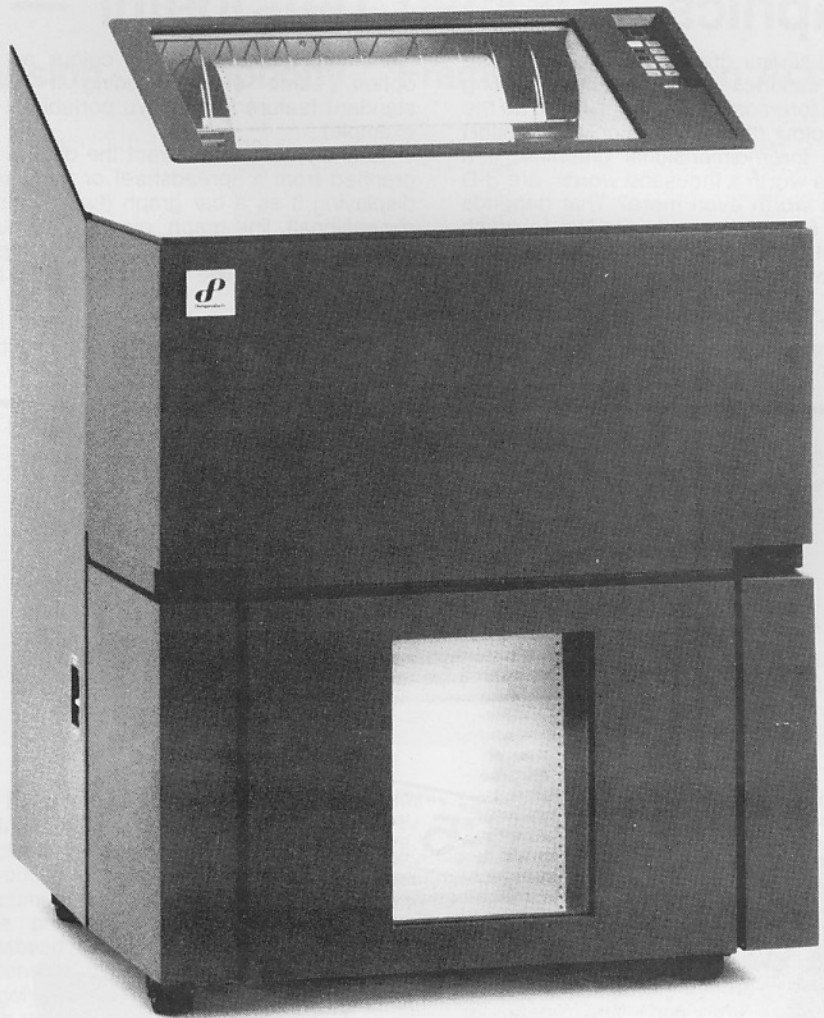

## **Dataproducts computer printers.**

For 22 years, they've been something of a secret shared by a cadre of high-technology customers — mainly the leaders of the computer industry.

Dataproducts makes more different kinds of computer printers than any other independent printer company in the world.

Dataproducts have learned more about when and where and how people use their computer printers. What jobs they need them to perform.

For example, if you're using your printer with a personal computer, you probably need one that can handle a variety of functions.

The pint-sized Dataproducts printer in the picture costs about as much as one good software package.

It prints spreadsheets, graphics and illustrations, labels, multi-part forms — even letters that look like they were typed.

The printer on the right finishes a full computer printout page in less time than it takes to sneeze. At 2,000 lines a minute, it prints much faster than you can see.

In between these two special-duty Dataproducts printers are whole families of other Dataproducts printers.

No matter what it is you will use your computer printer for, we ought to get acquainted.

**MEC** DEALER  
PRODUCTS

THE MICROCOMPUTER ELECTRONIC CO LTD,  
27 GREAT SOUTH ROAD, NEWMARKET, AUCKLAND.  
P.O. BOX 9224, AUCKLAND 1, NEW ZEALAND.  
TELEPHONE (09) 504-774, TELEX NZ 60721 MEC.

TCC11004

## SOFTWARE REVIEW

### Graphics

The business graphics portion of Open Access includes a number of interesting features foremost of which would be the use of colour (if you have a colour monitor) and the three-dimensional graphics. If a picture is worth a thousand words, are 3-D graphics worth even more? That depends on your needs. If you would like to graph the level of cash flow from four product lines over the next 12 months, the answer is yes.

Colour can be very useful in highlighting trouble spots in forecasts or bright spots in financial reports. More computer

manufacturers are offering colour as an option, some even including it as a standard feature (the Sanyo portable is an example).

Naturally, you can extract the data to be graphed from a spreadsheet or database, displaying it as a bar graph (two or three dimensional), line graph, pie chart (regular or exploded) or in overlaid graphs (superimposing a line graph on top of a bar graph).

If you do not have a colour monitor do not despair; you can still use this product with a monochrome screen, using a variety of

background patterns to differentiate the data items.

### Time management

Time, like many things, is not a renewable resource. Most business people would like more time, or be able to manage what they do have more efficiently. Open Access has included in its integrated package a time management module, which allows you to: maintain monthly calendars (up to 1999!); scratchpad calendar notes; daily appointment calendar; check for conflicts in appointments; search for appointments by subject or person; maintain a file of address/phone cards.

This time management module is an application written in the context of the information manager, and has the fundamental limits of 32,000 appointments, calendar notes etc. per file.

Whether a desktop electronic calendar will replace the paper variety remains to be seen. In most cases, I doubt it — certainly not until the computer is in our pocket, and we can talk to it (another five years?!).

### Summary

Open Access is an integrated suite of applications making use of common menu structures and data interchange via data file transfers. It uses windows to display certain fixed features of the package, but the windows are not interactive, not allowing the on-screen movement of data from one window to another. The package allows only one application to run at a time.

Documentation appears quite complete, but those who like well indexed technical manuals (who doesn't?) will be disappointed as the general level of indexing is poor. In spite of these limitations when compared to products like Symphony and Framework, Open Access is still a very functional and useful productivity tool.

### Seeking a Fortune

The major international computer group, Fortune Systems Corporation, has opened merger negotiations with the IBM compatible manufacturer, North Star Computers.

Fortune is one of the leaders in the commercial application of the Unix operating system and North Star has more than 100,000 of its IBM compatible Dimension, Horizon and Advantage workstations installed around the world.

## Printer Special

### Brother HR-5 with Adaptor



usually

~~\$625~~

Special  
offer  
**\$399**

Limited Stock

Imagine a fully featured dot matrix RO printer that can printout both **bidirectionally** and **unidirectionally**, on ordinary paper, and still fit into your briefcase, leaving room for your hand-held or home computer as well. And it's more than that. Since the HR-5 can operate on four standard sized **flashlight batteries**, it prints out a full 80 column page of your text, computer program or command list wherever, whenever and almost without a sound. Incorporating a **CENTRONICS parallel** or **RS-232C** serial interface, the HR-5 is compatible with many personal computers and a variety of software. Brother's high quality printer head not only **prints on ordinary paper** with its ribbon cassette but it can print on **thermal paper as well**. The HR-5 zips silently through your text at a good 30 characters per second, presenting you with a clean, clear hard copy right on the spot. Weighing-in at under 2 kg, the HR-5 is the lightest, most compact and versatile RO printer available today with a 3 month guarantee.

#### CASH with Order PLEASE

Please make your cheque out to:

Post to: **Business Electronics Ltd**  
61 Hobson ST. P.O. Box 588,  
Auckland. Ph. 798-569

Packing & Postage  
Total  
Cheque herein

|     |    |
|-----|----|
| \$3 | 00 |
|     |    |
|     |    |

## Comparison chart — integrated packages

| Feature                             | Vision | Symphony | Framework | Open Access |
|-------------------------------------|--------|----------|-----------|-------------|
| <b>Word processing</b>              |        |          |           |             |
| On screen special features          | yes    | no       | yes       | yes         |
| Bold, italic, underline             | yes    | yes      | yes       | yes         |
| Subscript, superscript              | yes    | yes      | no        | no          |
| Search, replace                     | yes    | yes      | yes       | yes         |
| <b>Spreadsheet</b>                  |        |          |           |             |
| Word processing features functional | no     | yes      | yes       | no          |
| Sorting                             | yes    | yes      | yes       | yes         |
| Macros available                    | no     | yes      | yes       | yes         |
| Auto. recording of macros           | no     | yes      | yes       | yes         |
| Finance functions incl. IRR         | yes    | yes      | yes       | yes         |
| <b>Database</b>                     |        |          |           |             |
| Virtual memory                      | no     | no       | no        | yes         |
| Word processing features functional | no     | yes      | yes       | no          |
| Wild card search                    | no     | yes      | yes       | no          |
| Linking with spreadsheet            | no     | yes      | yes       | yes         |
| Password control                    | no     | yes      | no        | no          |
| <b>Other</b>                        |        |          |           |             |
| Built-in programming language       | no     | yes      | yes       | yes         |
| Multitasking                        | no     | no       | yes       | no          |
| <b>Windows</b>                      |        |          |           |             |
| Size and placement by user          | yes    | yes      | yes       | no          |
| Interchange of data                 | yes    | yes      | yes       | no          |
| Common menu commands                | yes    | yes      | yes       | yes         |

## Overall summary

During this series on integrated business software, we have looked at the general topic, and reviewed four individual products. New integrated products are being released continuously. Some of them will undoubtedly be better (and some worse) than those reviewed. Which of these will win the current round of the micro-software sweepstakes remains to be seen. Without doubt, this will be determined in the marketplace based on: product speed; ease of use; functions provided; price; marketing.

A short synopsis of the products reviewed may be useful.

**Visi On:** Uses a mouse and icons much like the Apple Lisa. All standard applications are available, each at a separate price. Hardware requirements are high (512K RAM and a hard disk), and although it has many good features, it is quite slow in operation.

**Symphony:** A substantial upgrade from the excellent Lotus 1-2-3, adding a word processor, communications and upgrading the spreadsheet and database features. Extremely comprehensive, uses interactive windows to exchange data between applications (all applications are superimposed on an underlying spreadsheet). Its weakness is the level of effort required to learn to use it — this may prove too high for many.

**Framework:** Designed to work with dBASE III it is an easy-to-learn productivity tool which many will find suitable. The built-in outlining feature makes organisation of documents and reports a real pleasure. The primary weakness is the built-in database manager which is primarily an extension of the spreadsheet — this is largely overcome by the direct interface with dBASE III. It is very fast in most of its work and the use of windows is brilliant.

**Open Access:** Uses integration in a different fashion from the other three products. All four packages use co-ordinated menu systems, but Open Access is the only one which does not use interactive windows for data exchange between modules and allows only one application open in a window on screen. In spite of this, it is very useful, generally easy to learn and has the built-in time management module.

## YOU NEED US!

- Standard Telephone & Cables (NZ) Ltd
- Delphi Industries Ltd
- Databank Systems Ltd

These are just some of the manufacturers who recognise the advantages of employing

## PCB DESIGN SPECIALISTS

FOR EXPERT ADVICE ON — COMPONENT SOURCING  
 — PCB LAYOUT — BOARD MANUFACTURE  
 — COMPONENT SELECTION — PROTOTYPE ASSEMBLY

FOR PROFESSIONAL PCB ARTWORK DRAW ON OUR EXPERIENCE.  
 PHONE AUCKLAND 866-426



# CA DESIGN

# Chinese word processor promising

By Pat Churchill

A Wellington neurologist is developing a Chinese word processor on his BBC computer.

Many other people have tried unsuccessfully to do this over the past 15 years. But Dr David Fung is gradually evolving a system that looks like working.

Dr Fung, who came to New Zealand from Canton in 1950, attended school and trained at university here. His first contact with computers came in late 1970 while doing research on epilepsy in Essex. The system there involved a mainframe and paper tape "and that was the extent of my experience".

As time passed and equipment became more sophisticated, Dr Fung thought it time to get better acquainted with computers. Last year, he attended a computer course for medical people at Wellington Polytechnic.

It was then, viewing the graphics capabilities of an Apple, that he started wondering about the possibility of reproducing Chinese characters.

He was aware that for many years other people had been trying to evolve a Chinese word processor. "Even now, no Chinese books or newspapers are produced using a word processor."

One of the problems is that while English words are made up of 26 alphabetic characters, there are about 60,000 Chinese words, each individually different. How to code them was a major problem.

There are some five or six basic strokes in Chinese — horizontal, slanting left or right, a dot, crooked, vertical. Coding them was fine in principle, but words can have up to 25 strokes. Even simple words can have ambiguities. The length of a horizontal stroke in a Chinese character can change the meaning of a word — from "person" to "land", for instance.

Most people have used bit-patterns to define Chinese characters graphically. Dr Fung, however, defined the origin and end of each stroke according to the X, Y co-ordinates of a 24 x 24 grid.

"It's a system I've adopted and I don't see any reason to change it."

His developmental work has been done on a BBC computer, a system he chose because it fell into his price range and had high resolution graphics.

The 32K machine had 7 or 8K left after high resolution graphics were engaged. Dr Fung required at least about 50 bytes a word. For 5000 words, the 200K was

电步字 每是械的是在  
子和也个一从化所很工业  
计微有字个简汉以平业  
算型这也字单字英常发  
机化样是中是文的是文  
写及的特也部图文字英  
汉内复别没件形字用工  
字存杂与有字用笔作是  
也外障他字联笔划是由  
都存碍字体合划是二  
可储 不大小组成成适  
以容目同小的但是电个  
跟量前的的严是 虽子  
着的电 用裕这然计母  
进大子用规些部许算拼  
展扩计机规定部件多机音  
展算械定部件多机音  
从用机打所件多机音  
微的写以字汉的组用  
九型进汉每在字机成已

中文电子写字机

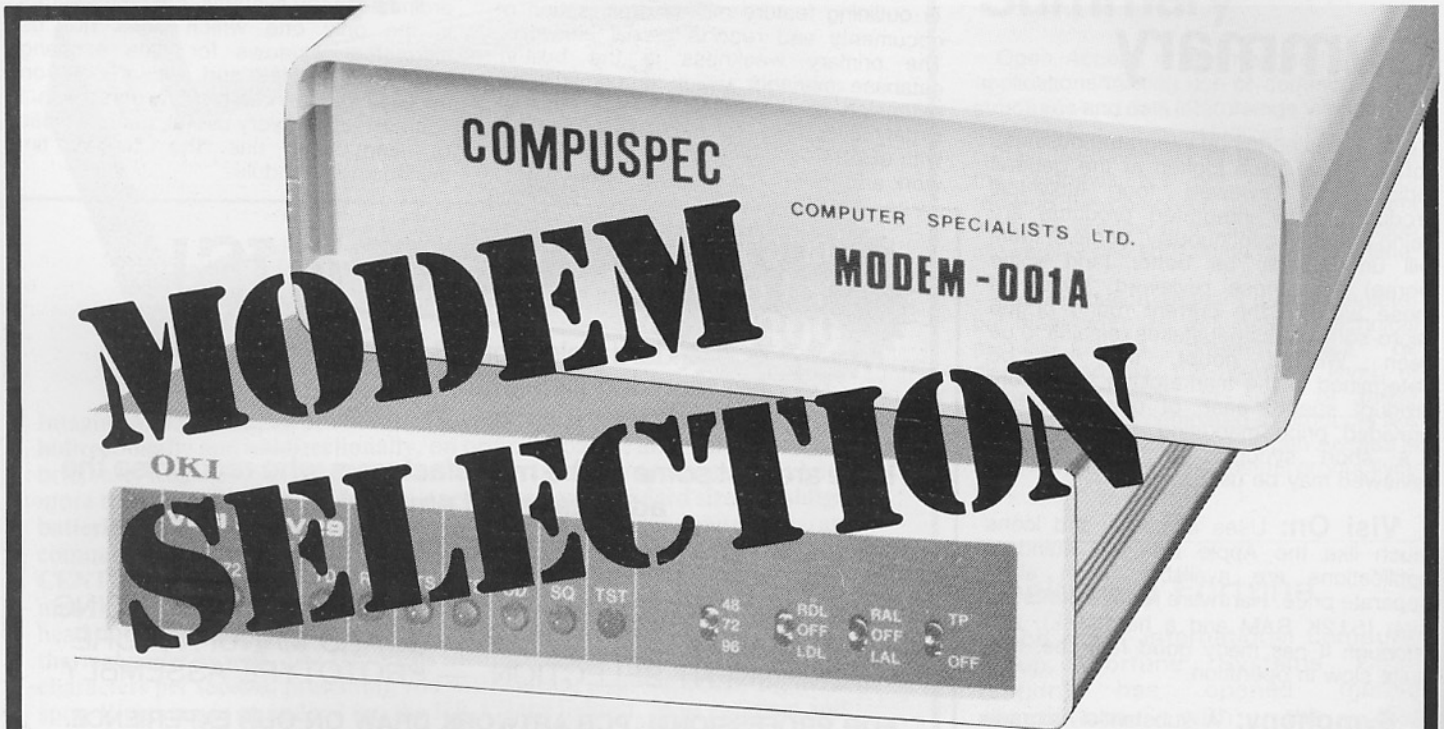

## COMWORTH SYSTEMS LTD. — MASTER MODEM DISTRIBUTORS

We've rationalised the high performance modem options to cover most requirements with NZPO type approved modems.

OKI Model VLSI 96/V29 9600 bps and OKI Model VLSI 48/V27 4800 bps modem for point to point data communications over leased lines.

IQ MODEM for PC's — an intelligent

modem for connecting your personal computer to the public switched telephone network and making it a workstation with full communication ability to the telephone data or videotex network.

**COMWORTH SYSTEMS** LTD.

P O Box 65 126 Mairangi Bay, Auckland 10. Phone (09) 478 7487

P O Box 3350 Wellington. Phone (04) 731 738

TCC 7005



这是新西兰 现在中国 我

国中文电子打字机 近来微型计算机的普遍化

和储存容量

的扩展进步用微型电脑

的扩展进步用微型电脑  
 字跟 重 什 做 什 我  
 字以 章 之 什 做 什 我  
 双可 发 用 业 业 业 业  
 写有 从 用 用 用 用 用 用  
 与有 从 用 用 用 用 用 用

我们要写汉字 时不是  
 我们要写汉字 和是

我们要写汉字  
 我们要写汉字

我们使用汉字你们海上一艘好不快

所以英文文字工  
 字母拼音组成的  
 文是由二十六个  
 是很平常的英  
 机的普通应用已  
 国家里电子计算  
 在工业发达的  
 中文电脑打字机

These samples of the printout of Chinese characters demonstrate the various formats.

Block 2 shows the features best. Block 3 shows the different thickness of the strokes on the same sentence - "We should write Chinese".

Block 1 reads:

Chinese electronic word processor.

In industrial advanced countries the use of computers is commonplace. English words are made up from 26 phonetic characters, therefore the English language is most suitable for computerised word processing. Chinese words are pictograms composed of strokes. Although many Chinese words are combination words made up from simpler radicals, these radicals in the individual words do not conform to standard sizes, therefore each word is unique. This is one of the obstacles in the mechanisation of Chinese word processing. In recent times the advances of miniaturisation of computers and the expansion of RAM and external storage capacity have enabled the development of Chinese word processing based on microcomputers.

Block 5 shows a portion of the above text.

## WORD PROCESSORS

stretching the capabilities of the BBC and its twin disk drives.

"I also needed an index of about 5000 words taking up a further 26K. I did that and got it working, but it was slow. It was taking up to four or five seconds for each word."

So Dr Fung got a second (6502) processor with a resulting 40K increase and put the index in that. Now it takes half a second for each word. He hopes eventually to put the whole file into RAM disk.

The complicated part of developing his Chinese word processor has been how to code the words. Ninety per cent of his efforts since he first got his system in 1983 have been devoted to developing a code.

"Many methods of coding have been tried in various countries over the past 20 years. Some 130 different systems have been evaluated and rejected, mainly because of unsatisfactory coding."

In Japan, Romanised pronunciation alphabet codes are used to call up the Chinese characters (Japan and Korea also use Chinese ideographs). The Chinese also use a Romanised system called pin-Ying on 32-bit mainframes.

"The trouble is the majority of Chinese don't know how to use the Roman system," Dr Fung said.

So far, he said, the best system had a two per cent ambiguity factor.

Dr Fung developed his coding system in a more pragmatic way, using a combination of perceptual and logical elements wherever practical.

Around 4000 words are adequate for a newspaper, according to Dr Fung. So far, he has coded about 5000. They require an average of four alphanumeric characters per word. A proposed keyboard will convert them into an average two keyboard strokes per word so that they are, in fact, faster to type than English words.

"This system has no ambiguities. I hope that if this is not the first serious attempt to produce a Chinese word processor on a micro computer, it could be the first successful one."

Dr Fung's next task is to tackle scrolling.

His whole program is written in BASIC; each word code is entered as a character string, then RETURN is hit. Normal word processing editing functions are used.

Horizontal or vertical writing is available (Dr Fung tipped the monitor on its side to demonstrate the latter). Words of different sizes and thickness can be formatted. A dump of a screen of text to the printer takes about 73 seconds.

"It is possible to produce tens of thousands of words from the keyboard. The limiting factor is it depends on how many are in the index."

One of Dr Fung's problems is that he has "a satisfactory career in the medical field" He can't afford the time to code all the words. As it is, he spends three or four hours a day after work testing and retesting his coding system. He has put a lot of hard work into his project since he bought his computer in May 1983.

He thinks his "Chinese people's word processor" will have practical application within a year.

Has Dr Fung been able to use his computer in his own medical field? "Not at the moment."

But, he adds, if he has enough energy, he'd like to work on the compilation of a Chinese/English medical dictionary. "A good one is needed."



**COMPUTERS FOR PEOPLE**

**FOR WANG PC SALES AND SUPPORT**

35 Taranaki St, Wellington  
Phone 847-668, 847-628

69a Rutherford St, Lower Hutt  
Phone 664-069

## HOW TO TURN THIS

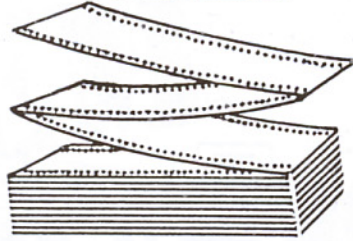

## INTO THIS



### PROBLEM:

As an EDP user you obviously face the monumental task of coping with the miles of material pouring from the printer at high speed.

To make this mass of printout information manageable it must be converted from continuous zig-zag folded stationery into readily accessible individual forms.

### SOLUTION:

CCP (Computer Printout Processing) is the answer and Bowe equipment is how you achieve it.

Bowe of West Germany has perfected equipment which matches the speed and accuracy of the printer's output. Its four main functions are: CUTTING, FOLDING and INSERTING... turning information into vital documents.

# BÖWE

**BOWE**  
CCP Equipment from

# Delairco

**Delairco Electronics Ltd.**

10 Lion Place, Auckland Tel: 79 8704

DEL23

Phone today or write for literature on Bowe Computer printout process. Or ask a Delairco consultant to contact you to arrange an obligation-free demonstration.

# Like finding gold

By Rev. M.L. Spackman

The chicken or the egg has its counterpart when it comes to upgrading or buying a computer. Do you decide on your computer and then look for a shop and a salesperson to sell you one, or is it more advisable to proceed in the reverse order? My recent experience suggests the two should be tackled in tandem — or preferably, find the right salesperson first!

I had come to the conclusion, rather reluctantly, that my small rubber-keyed home computer was just not adequate for business use — not that I had expanded it to its full capabilities! But even if I had, it would still be very much a home computer trying to do a business job. Most of the home computers either didn't have a respectable tough-type keyboard or else had severe limitations when it came to screen column width.

The question then came to mind: "Why not a small business machine?" Good thought! Two disk drives were considered mandatory to give maximum flexibility; 80-column screen width, word processing, spreadsheet and database programs were a must! I had some idea of what they could do, and what I wanted to do with them, but needed to find exactly which ones

matched my requirements! So my search began!

First, a list was drawn up of all the machines considered to be in the running, along with their appropriate advantages and drawbacks.

Second, columns to summarise the cost of "extras," such as additional disk-drive(s), interfaces, etc.

Third, the bottom line showing the total cost of each hardware package.

Fourth, the same analysis for the appropriate software.

## The moment of truth

Now dawned the moment of truth... the search for a "salesperson" who could grasp just where I was "at" and point me in the right direction. To my consternation, this proved far more difficult than assessing the relative merits of different software or hardware packages.

As I visited one shop or agency after another, I was amazed at the lack of personal interest shown by some attendants. In one shop, the attendant was polite, but "sorry my husband is out at the bank. He'll be back in an hour!" In another shop the attendant was only

slightly interested as I cast an eye around the variety of machines. In yet another, the sales manager was decidedly cool, with about an E rating for politeness, volunteering of information or interest in the customer.

My frustrating search continued. I had read and inwardly digested all the facts and information on the blurb-sheets, but it was the human aspect of buying a computer which finally brought me to a halt.

Was there no good computer sales person out there who understood the customer!... who could anticipate the questions he/she might want to ask, or could provide the information which a customer didn't realise he needed, but would be grateful to receive? Perhaps I had inadvertently discovered the missing dimension in salesmanship! Or maybe it was simply because the enthusiasts who opened up computer shops had had no training in selling?

## He respected my intelligence

And then, finally, almost at desperation level, I struck gold. (No! that

# INTRODUCING THE OSBORNE VIXEN.™

The company that introduced the first portable business computer is back.

### This is Vixen.

The essence of the Osborne concept.

Yet improved in every respect. We took the best features of existing Osbornes and put them in a smaller case. With a bigger screen. 80-column display. And even faster response time. Result: The most powerful portable in its class. The Vixen is a fraction of the size of other Osbornes — yet it's packed with features lap-sized computers make you sacrifice.

### Designed to endure.

Look what Osborne gives you now:

- Two double sided double density half-height 400K disk drives let you store up to 100 typed pages per disk.
- 7-inch diagonal, power-saving built-in amber monitor.
- 80-column, 24-line display with easy-to-view, 8 x 10 dot characters.
- Serial and parallel ports let you connect the Vixen to any printer or modem.
- CP/M® operating system, for access to the huge library of CP/M productivity software.
- 90-day warranty.
- All in one neat little package.

### The Vixen is data-disk compatible with IBM PCs — and more.

Free Media Master™ software lets you exchange data diskettes between the Vixen and over 200 other computers, including the IBM PC.

Your computing capabilities just expand 200 times over.

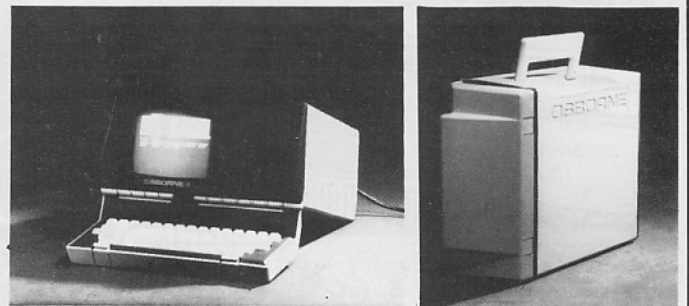

**OSBORNE**

### Free productivity software: An Osborne tradition.

When you buy the Vixen, we give you software tools for writing, for creating spread-sheets, custom programming, graphics and plain having fun. You get Wordstar® /Mail Merge,® Super Calc 2,™ Desolation, Media Master,™ MBASIC Osboard and TumKey, Free.

**\$3978 complete with software**

## New Zealand Osborne Distributors



34 Te Pai Place,  
Henderson, Auckland, 8.  
P.O. Box 83-118,  
Edmonton, Auckland, 8.  
Phone 836-3784

### CONTACT YOUR NEAREST OSBORNE DEALER

Sirius Systems Ltd., Auckland. Phone 836-3784  
Thames Radio & Electronics Ltd., Thames. Phone 86-768  
Lakeland TV & Stereo, Taupo. Phone 88-888  
Compusales Ltd., Wellington. Phone 844-146  
Peanut Computers, Chartwell, Wellington. Phone 791-172  
Ross & Staig TV Services, Nelson. Phone 80-397  
Businessworld Computers Ltd., Christchurch. Phone 64-617  
Eclipse Radio & Computers Ltd., Dunedin. Phone 778-102

# AVM COMPUTERS

# Radio Shack®

## INTRODUCING THE NEW TANDY 1000 MS-DOS PERSONAL COMPUTER

Packs Everything You Need  
Together—including Software



# SAVE \$2500

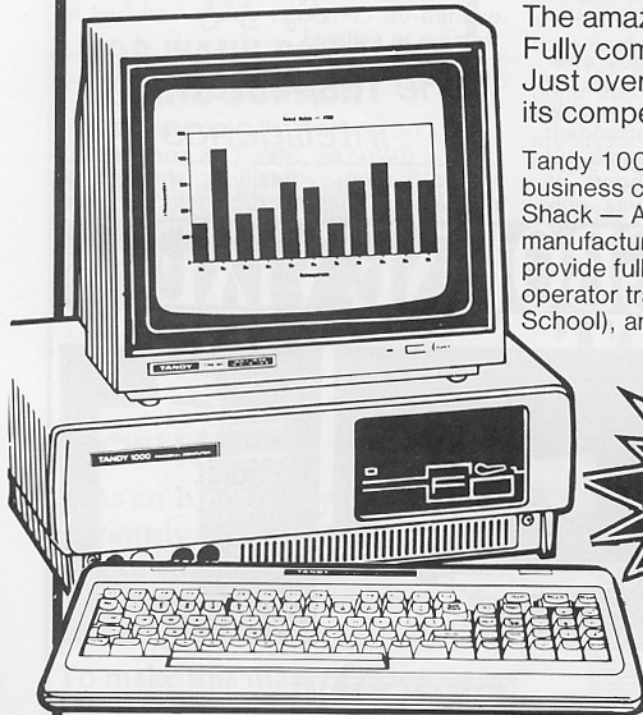

The amazing Tandy 1000 P.C.  
Fully compatible with IBM.  
Just over **HALF THE PRICE** of  
its competitors.

Tandy 1000. The latest addition to the  
business computer range from Radio  
Shack — America's largest  
manufacturer of small computers. We  
provide full software back up, plus free  
operator training (in our Computer  
School), and finance plans.

**\$4945**  
**OR FROM**  
**\$207**  
**MONTHLY**

HIRE PURCHASE, RENTAL OR  
USAGE PAYMENT PLANS.  
TALKING TO US COULD SAVE  
YOU A LOT OF MONEY.

**Comes with DeskMate™ Disk Software  
for Word Processing, Electronic  
Filing, Spreadsheet Analysis,  
Telecommunications and More**

Tandy 1000 gives you more features than an  
IBM PC for less money! Plus, unlike the PC, every  
Tandy 1000 comes with DeskMate software, featur-  
ing applications you want most. IBM PC compatibil-  
ity lets you choose from the most popular software  
on the market.

MS/TM Microsoft. IBM/TM International Business Machines Corp.

**P.O. Box 2823 PH. 797-279**  
**149 HEREFORD ST. CHRISTCHURCH**

## BEGINNERS

wasn't his name!) Yes! I found a salesman who actually took people seriously! Someone who was patient with a mildly computer-literate person like me who had to ask simple (probably to him "dumb") questions, but certainly never hinted that was how he felt about them (if he did). He actually respected the intelligence of the customer!

You see, I knew how to load and save programs on tape. That was easy. I could write programs in BASIC. But I had never had any experience with disks... in fact never even handled one. As for understanding MS-DOS! This was a whole new field (no pun implied) and like most beginners, felt woefully inadequate and self-conscious when talking with an "expert."

It was about 5:45pm, hurrying home from an interview when I passed this shop. At this stage, I was still trying to compare the machines adequately, but without much help from some assistants.

The shop would surely be closed but I thought a few minutes looking through the window might be interesting. The lights were still on. As I gazed at the line-up of machines inside, a movement from behind one of the office partitions caught my attention. A cheery, well groomed assistant approached the door and asked if I would like to come in. My "just looking thanks" comment didn't deter his invitation, so I gratefully accepted and entered the shop. What I found different with this (polite, courteous etc) salesman was that he didn't try to sell me a machine but asked questions first.

"Are you attracted to any particular machine?", "What would you be requiring it for?", "Have you used a machine like these before?"... and so on. What I realise now is that he was building up a personal mental dossier of just where I was at. He could then anticipate my questions, neither talking "down" to me nor "over my head." When I admitted I had no experience using disk drives, I was not given a scornful "what an idiot" glance but a reassuring "it's no trouble at all... here I'll show you what you do."

I warmed to this kind of salesperson who seemed human. "Hands-on" trial was offered and gratefully accepted. The advantages and finer points of the machine I was interested in and the software which came with it were carefully explained. His own particular expertise was with the spreadsheet programme. I was introduced to the boss who, I was assured, was more familiar with the database and word processing programs, as well as technical understanding of the machine in question.

I became more and more impressed, both with the machine and with the salesman. Financial details had still to be finalised on the home front so no promise could be given or contract signed. I appreciated his sensitivity on this matter.

**Subscribe today**

*Silent doubts intercepted*

But I was still just a little apprehensive about whether or not the software suite would exactly fit my requirements. I had been caught out once before when I had bought a "compatible" machine, only to find it very much "incompatible." My silent doubts were quickly intercepted and I was offered the loan of the ring binder manuals for one of the programs.

Here was surely an example of trust and goodwill. No pushing of the merchandise on to an unsuspecting or uncertain customer just to make a sale. "Take it home for the weekend and see what you think of it!" Here was a salesman who tried to please and, in the process, won a customer.

The machine and a printer were purchased after some very helpful financial arrangements were made with

the same friendly courtesy. When the day arrived to take delivery of the package, a time was pre-arranged so that the salesman would be free and uninterrupted. The machine was lifted from its copious packing of polystyrene right before my eyes so that each part could be carefully inspected to my satisfaction.

It was assembled, plugged together (each step carefully explained) and finally switched on. Nothing happened! A careful recheck of all the connections. Still no life! The manager was summoned (he had the technical knowledge). Again, everything was checked. There was no life from either disk drive, not even the indicator light. A small screwdriver was summoned and the case unscrewed. The culprit was clearly revealed. Neither of the two disk-drives had been plugged into the motherboard. A few seconds later (just time for me to have a look inside) and all was humming merrily away.

I didn't really think the pre-delivery check was necessary. After all, I had been a "ham" for just on 25 years and an enthusiastic constructor. But I was grateful that they took nothing for granted. I can just imagine the deflation of ego had I arrived home with my new "toy," plugged in, and nothing happened!

I have had cause to ring only twice for further explanations on some fine points which the manuals had overlooked, and each time was met with a warm and most helpful response. My congratulations to the salesman concerned. He is truly a professional.

Oh, the name of the machine? A Sanyo MBC-555. A great machine with some fantastic software, and at an almost unbelievable price. The name of the firm? Well, that just might be giving it away too much! See if you can find him in your search?

**"If you want to do it right...  
XIDEX - it!"**

*The Precision Flexible Disks*



Having carefully selected and purchased your computer you now want to be sure of optimum operational performance and that's where Xidex Precision Flexible Disks come in.

Xidex Precision Flexible Disks are produced to a production level that exceeds all known industry standards world wide and that delivers real benefits to you the end user.

The Disk Jacket is 33% thicker which helps eliminate contaminants and damage from extensive handling. Each disk is quality controlled by 18 exacting tests and each and every 5 1/4" and 8" disk carries a 10 YEAR WARRANTY — BEAT THAT. Also, every time you buy 10 x 5 1/4" disks we give you a free unique library file! Every disk is guaranteed 100% error free, so, if you want the very best and you want to do it right Xidex — it! today.

Distributed by:

**XIDEX New Zealand  
Dealer enquiries welcome**

P.O. Box 6501 Wellington.  
Telephone 843-788.

**XIDEX**  
NEW ZEALAND LTD.

**Businessworld**  
COMPUTERS LIMITED

XIDEX NEW ZEALAND LIMITED have appointed all BUSINESSWORLD locations as a master distributor for their precision flexible disks. For purchase of XIDEX Products, contact your nearest BUSINESSWORLD COMPUTERS LIMITED Branch.

# From teacher to trader

In recent years, there have been a number of arguments about computers in schools, many focussing on the hardware choice and its implications.

However, as the use of computers in schools grows, the philosophy behind the educational requirements has also evolved.

A number of computer companies have taken an "educationalist" under their wing to assist in developing stronger communication with the educators and those influencing the hardware choice in schools. (This choice seems to come down to individuals in schools involved in the use of and/or the fundraising for the equipment).

A former teacher from Waiheke College, (and before that Auckland Girls' Grammar), Peter Revell, is one of these educationalists who has taken the opportunity to "work with education from the other — business — side" for a few years. He recently joined Barson Computers NZ Ltd, the distributor of the Apricot and BBC computers.

Peter believes computer studies

need to move away from dedicated programming and application courses to general studies which use computers and computing as a tool. From his as yet brief experience in the commercial world, he has observed several areas of frustration for parties on both sides.

"At this very moment, we have a system in a college that is down. I really feel for the head of computer studies there because he is left with a day of classes to entertain — and those lessons to catch up on later."

This is especially difficult where there are few computers in a school and access is limited for the huge numbers of students seeking experience in the field.

On the other side of the coin, while the distributors will do all they can to assist in such a situation, other areas of support can be abused.

"We have a tremendous range of software here that I would like teachers to try out. We recognise it's especially difficult for those out of the main centres to keep up with what's available, but to provide software for reviewing, we would

have to be confident there would be no piracy."

And the reality is that educationalists have established some notoriety for their ability to pirate software from a wide range of sources . . . perhaps understandable when you have a group of people keen to advance with the latest technology — and a funding system that falls very short of matching that growth.

Not all educationalists are convinced the new technologies are the way of the future though. In some schools, there is a concerted effort by some key staff members to steer clear of the revolution.

Revell has noted two distinct areas showing a reluctance to get involved: teachers in the primary area, an area he considers highly important because there are few, if any prejudices from the pupils; and a reluctance on the part of many female students.

Many of the male students become attracted through games and then want to develop computer skills to create their own, he says.

## GOOD FURNITURE IS IMPORTANT TO THE EFFICIENT OPERATION OF YOUR COMPUTER SILKWOOD FURNITURE IS GOOD

- Practical
- Efficient (Ergonomic)
- Modular
- Full Work Stations
- Closeable Units
- Unique (registered) Designs
- Unique Polished Finish
- Matching Bookcases/Cabinets



Many More Efficient Office Work Stations Built Up From Exactly The Modules You Need — **Extendable.**



This "DATA CENTRE" Wheels Anywhere — Opens Up To A Complete Work Centre — Takes Most PC's With Printer. **\$374 plus freight**

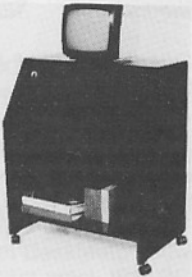

"COMPUTER BUREAU" Perfect For Home Computers. Everything Tidy And Efficient. **\$258 plus freight**



All Silkwood Units Have **Unique Copy Shelf** Between Keyboard And Screen.

Brochures/Prices/Retailer List from:—

# SILKWOOD

Manufacturing Ltd  
8 Tironui Road Papakura, Auckland Phone 298 7089

However, fewer girls are attracted to the games and thus to computing, although there are a number of women heading computer studies departments in secondary schools.

Schools' computer needs vary, depending on the applications; schools need to analyse their requirements and priorities, whether they be music or commerce, before making their choice, which will almost certainly be tempered by financial constraints.

And it is to help qualify those needs and provide communication between commerce and the teachers that Peter Revell has taken a sojourn into the commercial world.

"I have an empathy with the teachers' situation and any recommendations I make, I have to believe in.

"There are a variety of options available and it's important the first step taken is to establish the school's priorities and needs. That move alone can be a pointer toward the most suitable hardware for the job.

"I have been in the situation of many of those making this decision — and could be again when I return to the classroom."



*Peter Revell... on the "other side"*

# SUPATECH **SPECTRUM** SALE

## 16K



includes \$200  
**FREE** Software

30 only, offer only  
until stocks run out.

**Send to: SUPATECH ELECTRONICS 430 Mt. Eden Rd., Mt. Eden, Auckland. Ph 60-5216**

Name .....

Address .....

Phone No .....

|                                     |          |    |     |    |
|-------------------------------------|----------|----|-----|----|
| Please send me .....                | Quantity | \$ | 299 | 00 |
| ..... Spectrum 16K                  |          | \$ | 2   | 00 |
| ..... Postage & Handling            |          | \$ | 24  | 95 |
| ..... plus power supply if needed   |          | \$ |     |    |
| I enclose my cheque/money order for |          | \$ |     |    |

Please charge to my credit card No: .....

Type of card: .....

Expiry date: .....

Signature of Cardholder: .....

# LETTERS

## Poor support

After some time surveying the various PCs on the market, I settled on the Atari 800 XL. The Atari has many outstanding features which I am gradually assimilating into education programs (my first love) with some success.

My major concern is that there appears to be many Atari owners wandering around in limbo in my area of the country. Glancing through American magazines - I use the

word glancing, as that is all you can do - I notice thousands of possibilities in hardware and software which we, in this country, can only dream about.

This would not overly concern me if it were not for the fact my fellow enthusiasts with most of the other brands can obtain the same hardware and software in greater variety and at a fraction of the price here in New Zealand. What are the

Atari distributors in New Zealand thinking of - providing a good machine but failing to go anywhere near competing with the other distributors in the software area?

I wonder if there is any point in developing my own software in education programs. Perhaps in time, the Atari will sadly die, as owners realise what a poor back-up deal the distributors are giving to the customers. Are they really trying to compete in variety and price with the others?

I have some reading and Maori language programs on my trusty ZX81 and wonder if it is worth the trouble modifying them for the Atari!  
- R.G. SUTTON (Turangi).

## Monaco's comment

In reply to R.G. Sutton I would like to make the following observations.

I do sympathise with Mr/Mrs Sutton's plight in respect of educational software, particularly in relation to reading or Maori language. People like your correspondent have informed us that the American style reading programs are not suitable for the New Zealand education system. As far as Maori is concerned, it would be almost impossible to obtain a program commercially for this subject. It is of high interest, no doubt, but only to a small group in market terms.

Last year, as no doubt all are aware, was a very turbulent year for Atari, full of difficulties and uncertainties about supply, resulting in a shortage of many lines. Notwithstanding this, we managed to increase significantly the number of Atari owners and increased the range of software titles available by around 200% compared to the period before Monaco became the distributor.

In addition, we specially introduced some software into the educational range specifically aimed at the primary school age group. The total number of Atari software titles available at present is 101.

However, owing to the rapid growth in the number of Atari owners and strong encouragement from us, a number of other companies have started importing and are selling a large number of Atari third party software titles covering a wide field of application, thus boosting the total number of

# TANDY COMPUTERS DISCOUNTED!

**MOLYMERX MAIL-ORDER PRICES and TANDY Computers**  
The best combination in New Zealand

| Model Computer  | Retail Price                                   | MOLYMERX COMPUTING MAIL-ORDER PRICE     | DOLLARS SAVED                             |
|---|--|---|---|
| <b>TANDY 1000</b><br>IBM PC Clone<br>128K RAM<br>1*360K Disk Drive<br>Expandable to 640K<br>and Hard Disk Dr<br>IBM "extras" such as<br>parallel printer port,<br>Colour graphics, mono. adapter,<br>are supplied FREE as is<br>MSDOS & GW BASIC<br>MOLYMERX supplies FREE-<br>a useful INTEGRATED SOFTWARE package | <del>\$3795.00</del>                           | <b>\$3489.00</b>                        | \$315.00                                  |
| Model 1000 - 2 Drives<br>Green/Amber Mon  | <del>\$4510.00</del><br><del>\$380.00</del>    | <b>\$3996.00</b><br><b>\$ 279.00</b>    | \$514.00<br>\$ 83.00                      |
| <b>TANDY 1200</b><br>IBM XT Clone<br>10 Meg Hard Disk<br>+ 1*360K Fl. Disk  | <del>\$9085.00</del>                           | <b>\$8590.00</b>                        | \$495.00                                  |
| <b>TANDY 2000</b><br>The state of the art!<br>8Mhz 80186 MSDOS computer<br>2 * Disk Dr<br>10 Meg Hard Disk<br>Built-in  | <del>\$7690.00</del><br><del>\$12,810.00</del> | <b>\$ 7080.00</b><br><b>\$11,473.00</b> | \$610.00<br>Save an astonishing \$1337.00 |
| <b>TANDY 100</b><br>(Portable Perfection)<br>8K<br>24K  | <del>\$1690.00</del><br><del>\$2100.00</del>   | <b>\$1280.00</b><br><b>\$1690.00</b>    | \$310.00<br>\$410.00                      |

### SOFTWARE AVAILABLE from MOLYMERX COMPUTING

OPEN ACCESS, LOTUS 123, MULTIPLAN, MULTIMATE, pfs SERIES, DB II, DB III, HOME ACCOUNTANT, PC DRAW etc  
SYBIZ ACCOUNTING, CHARTER ACCOUNTING, MODEL 100 ROM SOFTWARE

(You'll like our prices for these too)

### HOW TO ORDER THESE BARGAINS

MOLYMERX COMPUTING HAS A 24 HOUR ORDER LINE for  
PHONE ORDERS (Answerphone) - Ph. AUCK (9) 817-4372

Advice Line is (9) 836-9873

VISA, BANKCARD, BANK DRAFTS & CHEQUES accepted as are  
Personal Cheques (but see THE FINE PRINT below).

Written Orders to P.O. Box 60-152 (18 Okewa Rd.) Titirangi Auck.  
Telex: 60657

### THE FINE PRINT

Cheques Not cashed or Cards debited until goods are dispatched. Personal cheques must be cleared prior to dispatch. Freight is extra eg Model 1000 to Wellington is about \$75. Any delay in dispatch order beyond 24 hours will be notified personally to allow you the option of cancelling your order.

### AND WHO THE HELL IS MOLYMERX?

We have been selling Mail order software mainly for Tandy and System 80 computers in New Zealand for 3 years. We have an Australian subsidiary and thousands of well served and satisfied customers in both Australia and New Zealand. We can offer ther AMAZING hardware prices because we have excellent contacts in the USA and England who trust us to act well on their behalf and who can buy in the enor - mous numbers to allow them to sell to us at prices New Zealanders have only dreamed about until now.

**1985 is the year when Sales Tax is down and the goods tax not yet introduced. Buy mail order NOW if you know what you want and demand the best prices. It will never be less expensive!**





available software titles of over 400.

Living in Turangi, a place I know well (although for a totally different reason than computers — it is my favourite trout fishing spot), might make it more difficult to be totally up with developments in the Atari hardware and software range. Naturally, any request of this nature directed to us by your correspondent would be actioned promptly.

We accept that the emphasis of the software is on entertainment, but since worldwide, more than 65% of software sales still remain in that area, this trend will not come as a very great surprise.

What about all the other titles and nice things advertised in the American magazines which one can just "glance" at, as your correspondent points out? Well, that is something we will have to accept as a reality. The same can be said of many other product lines magazines in bookstores.

I am not certain which magazines your correspondent is referring to, but if the *Antic-The Atari Resource* and *Analog Computing* magazines we import in support of Atari computers are those in question, at least they provide evidence that:

- Atari home computers are a mature product with a well established large user base.
- They contain a host of tips and information exclusively for Atari users and, in addition, at least four interesting type-in programs.
- They give your correspondent an indication of things to come.

None of these are provided for in any home grown magazine.

Although Atari has been well established in USA, it is only very recently that a real effort has been made to market it in this country and, I might add, with a considerable degree of success.

We have sent your correspondent the latest information regarding Atari and the new products as well as a software catalogue.

With reference to the comment on pricing, we invite your correspondent to make an objective price comparison between the comparable brands on the market. We believe your correspondent may have to revise his/her opinion on that score.

If your correspondent is wondering whether or not to develop some educational programs for the Atari, I suggest please do! Remember, it is because of the activities of all computer owners combined that a software base will grow and be able to cater for special needs. This is one

of the interesting and challenging points about owning a home computer and not having the ready, off-the-shelf, specialised software provided. Call it pioneering, if you like.

We would also like to congratulate your correspondent for selecting the finest home computer money can buy, even though it is recognised that we have to do some more work in the support areas which, with a technology based, fast evolving product, will have to go on forever regardless.

The fear expressed by your correspondent that Atari "will sadly die" will have to be dispelled to the land of fairytales. Atari has never looked stronger or more ready to take on the market than in 1985!

— FELIX MEIJER (Divisional Manager, Atari, Monaco Distributors Ltd).

Buy computer books today

# SuperWriter™

**SORCIM**

## SUPERWRITER

SuperWriter from Sorcim is a fully integrated text processing system that allows you to create, edit and print letters and reports. SuperWriter also checks for correct spelling. This greatly increases productivity and expands the range of tasks office workers can tackle quickly and efficiently.

SuperWriter makes the most of your video terminal. It supports draft and letter quality printers simultaneously. It makes the fullest possible use of any terminal features eg. highlight, underline, low intensity and any programmable function keys.

SuperWriter makes mailing lists and form letters a breeze. Up to 120 variables, each up to 55 characters, can individualize standard text. SuperWriter can adapt to existing file formats to extract data. You can skip unneeded portions, select specific records and merge records all to specified files.

SuperWriter's documentation is typeset and with easy-to-comprehend screen display examples. The unique "Answer Key" facility means that the manual is available to you "on-line", keyed to the operation you are currently doing. This is a great help for those commands which you use only occasionally.

An exclusive feature enables SuperWriter to load up SuperCalc and to read and write files in its own format, or those used by other popular products.

SuperWriter is available configured for the IBM PC under PC DOS, or for systems running MP/M, CP/M-80 or CP/M-86. A minimum of 56K of internal memory is recommended for efficient operations.

**SuperWriter**  
The word  
processing  
software from  
the company  
that brought you  
**SuperCalc.**

**\$599\***

(price subject to exchange fluctuations)

Includes mailmerge, spelling checker & printer spooling

### Contact NZ Distributors

Computer Store  
div. of Albertland Enterprises Ltd.  
P.O. Box 31-261 Ph (9) 499-458 Auck.

Dealer Enquires welcome.

Send to Computer Store  
FREEPOST 907  
P.O. Box 31-261  
Auckland, 9.  
Ph. (9) 499-458

Yes I want to learn more about your quality software. I use a

CPU..... DOS.....

Main interest:  WP  Languages  
 Financial  Other

NAME.....

ADDRESS.....

# Minotaur's Maze

by David Gilbert

In this 16K game, you must move through a maze while avoiding a minotaur. The game begins with you at the top left-hand corner of the screen, and the minotaur at the top right-hand corner. At this stage, the maze is invisible, but as you move, the nine squares around you are revealed. Thus the maze gradually becomes visible as you try to reach the bottom right-hand corner.

The program, as listed, contains one maze, but more can be added. This can be done by moving lines 61, 62, and 63 to 900, 901, and 902, and then adding the new maze(s) between lines 50 and 900. After each maze, add a line GOTO 900, and to cause a maze to be selected

```
at random, add:
6 LET Z=INT(RND*NUMBEROFMAZES)+1
7 GOTO (Z * 50)-40
```

```
10 DIM A$(20,30)
11 LET A$(1)= ""
12 LET A$(3)= ""
13 LET A$(4)= ""
14 LET A$(5)= ""
15 LET A$(6)= ""
16 LET A$(7)= ""
17 LET A$(8)= ""
18 LET A$(9)= ""
19 LET A$(10)= ""
20 LET A$(11)= ""
21 LET A$(12)= ""
22 LET A$(13)= ""
```

```
23 LET A$(14)= ""
24 LET A$(15)= ""
25 LET A$(16)= ""
26 LET A$(17)= ""
27 LET A$(18)= ""
28 LET A$(19)= ""
29 LET A$(20)= ""
50 CLS
61 PRINT "
```

```
62 PRINT "THE OBJECT OF THE G
AME IS TO MOVE YOUR MAN FROM
THE TOP LEFT CORNER OF THE
MAZE TO THE BOTTOM RIGHT CORNER
LE UNTIL THE MAZE IS INVISIB
. HE WILL TRY TO CATC
EAT YOU.
=7, DOWN=6, LEFT=5, RIGHT=8, UP
```

```
63 PRINT "THE MINOTAUR WILL S
TART AT THE TOP RIGHT CORNER OF
THE MAZE. HE WILL TRY TO CATC
H YOU AND EAT YOU.
PRESS ANY KEY TO
```

```
998 IF INKEY$="" THEN GOTO 998
999 CLS
1000 PRINT "MINOTAUR'S
MAZE
```

```
1010 FOR I=1 TO 18
1020 PRINT " ";TAB 30; " "
1030 NEXT I
1040 PRINT "
```

```
1050 LET X=2
1051 LET MX=2
1052 LET XX=2
1053 LET MMX=2
1054 LET MMY=29
1055 LET MY=29
1056 LET YY=29
1059 PRINT AT XX,YY;" "
1070 PRINT AT X,Y;" ";AT X-1,Y-1
;A$(X-1,Y-1);AT X-1,Y;A$(X-1,Y);
;A$(X-1,Y+1);A$(X-1,Y+1);AT X,Y-1;
;A$(X,Y-1);AT X,Y+1;A$(X,Y+1);AT
;A$(X+1,Y-1);A$(X+1,Y-1);AT X+1,Y;A$(
;X+1,Y);AT X+1,Y+1;A$(X+1,Y+1)
1071 LET YY=Y
1072 LET XX=X
1073 IF X=19 AND Y=29 THEN GOTO
9500
1050 PRINT AT MMX,MMY;" ";AT MX,
MY;" "
```

```
1061 LET MMX=MX
1062 LET MMY=MY
1083 IF MX=X AND MY=Y THEN GOTO
9000
1090 LET X=X+(INKEY$="6" AND A$(
X+1,Y)=" ")-(INKEY$="7" AND A$(X
-1,Y)=" ")
1100 LET Y=Y+(INKEY$="8" AND A$(
X,Y+1)=" ")-(INKEY$="5" AND A$(
Y-1)=" ")
1110 LET MX=MX+(MX<X AND (A$(MX+
1,MY)=" " OR A$(MX+1,MY)=" ") )-
(MX>X AND (A$(MX-1,MY)=" " OR A$(
MX-1,MY)=" ") )
1120 LET MY=MY+(MY<Y AND (A$(MX,
MY+1)=" " OR A$(MX,MY+1)=" ") )-
(MY>Y AND (A$(MX,MY-1)=" " OR A$(
MX,MY-1)=" ") )
9000 GOTO 1059
9999 STOP
9000 CLS
9004 PRINT "
```

```
RED BY THE YOU HAVE BEEN CAPTU
EVIL MINOTAUR.HE WI
LL TAKE YOU
BACK TO HIS CAVE AN
D HAVE YOU
FOR SUPPER.
```

```
RY AN EASY YOU SHOULD GO AND T
"PACMAN" MAZE GAME SUCH AS "
```

```
PLAY AGAIN. PRESS ANY KEY TO
```

```
9005 FOR I=1 TO 70
9007 NEXT I
9010 IF INKEY$="" THEN GOTO 9010
9020 CLS
9030 RUN
9050 CLS
9060 FOR I=1 TO 78
90610 PRINT " ESCAPED "
90620 NEXT I
90630 PRINT AT 12,0;" "
```

```
KEY TO PLAY AGAIN. PRESS ANY
9040 GOTO 9010
```

## 90 Page Software Catalogue for TRS-80/System 80 Users!

as we publish new software we send you free UPDATES.  
Our offer is to keep you informed of NEW products,  
NEW services and our regular special prices.

Fill in the coupon and return to:



**Molymex Ltd.**  
P.O. Box 60-152  
Titirangi,  
AUCKLAND  
NEW ZEALAND  
**(817) 4372**

Bankcard/Visa accepted

I enclose \$ . . . . . at \$5.00 per copy  
TRS 80 Catalogue

Name . . . . .

Address . . . . .

Phone . . . . .

Dealer enquires welcome



## MICRO SOFTWARE HIRE CLUB

OPEN WEEKDAYS & SATURDAY MORNINGS

### Commodore VIC20 & 64 BBC - SPECTRUM - ELECTRON

☆☆ BRANCHES ☆☆

**AUCKLAND**  
C.B. CENTRE PH 444-8063  
15A Porana Rd., Takapuna  
THE COMPUTER TERMINAL PH 419-0543  
257 Hinemoa St., Birkenhead  
ROSEBUD VIDEO CENTRE PH 864-151  
16 New Bond St., Kingsland

**ROTORUA**  
CHANNEL FIVE PH 89164  
87 Fenton Street

**GISBORNE**  
PERSONAL & BUSINESS COMPUTERS LTD  
PH 88-256 115 Gladstone Road  
NEW PLYMOUTH  
TRIO BUSINESS CENTRE LTD PH 85-226  
635 Devon Road  
TOKOROA  
COMPUTER CENTRE PH 64-900  
Dreghorn Place  
TAURANGA  
OPENING SOON

★ ★ Trade enquiries welcome ★ ★  
A Branch Franchise may be available in your area.  
Please Contact Phone 444-8063 or write  
Box 33-196 Takapuna, Auckland.

# Help with your business

By Dick Williams

Here's a program suitable for small companies or individuals who feel they need some assistance from computers in their business activities.

Along the way, you should be able to see the routines I will be using, and why, and be able to use them in your own programs.

Most programs, even the very large and sophisticated, are made up from a collection of short routines or small self-contained mini-programs within the main program. This way of building up a program from small bricks helps a lot in getting a program to run the way you intended.

It is easier to test parts of the program in isolation from the main program, and it is less difficult to incorporate additional features to a program if there is some kind of structure to it.

One of the easiest ways to give a bit of structure to a program is to put a REM (short for REMark) line at the start of a section of program, and leave a few spare lines between blocks of program. For example, lines 10 to 50 for the main part of the program and lines 1000, 2000, 3000, 4000 for small subsections

of program. This makes it fairly easy to see what you are doing and at the development stage of a program, that's high on the priority list.

After getting a program running and actually doing what it's supposed to, I start removing spaces and tidying up the program. For example, a print statement such as PRINT "JIM" would be squeezed up to PRINT"JIM". This saves one byte and the program runs fractionally faster.

Over a long program, a lot of bytes can be trimmed out with a consequent reduction in program length, and less time spent saving and loading. A small reduction in run time is achieved by placing sub-routines near the beginning of a program because the computer always starts from the beginning checking every line for the right one.

It can be very confusing though, to have subroutines mixed up with parts of program. I find it more productive to place them at the end of my programs while getting them working, then sometimes move them up nearer the front.

I find it easier to make a program that is easily read and makes some kind of sense as you read it rather than one that is all over the place.

Most business programs call for an input module which allows for input from the keyboard and is usually set up in advance so that various users can easily understand what they have to do. In addition, there has to be some form of aborting the input in the event of a mistake, together with a means of trapping errors or illogical inputs.

One input line may be for alphabetic characters only, and the computer must be able to tell if an incorrect entry has been made and advise the operator. The program here uses one type of input module which will accept any input data and requires the operator to verify that the information is satisfactory before committing it to the computer's memory. This can be extended further to allow only alpha on one input line and say numerals on others.

There are all sorts of possibilities, depending on the end use. After verification of the input data, the computer will put all three sets of input

## DID YOU KNOW?

That in a comprehensive review, taking 5000 hours, of 14 productivity packages including Open Access and Symphony. . . .

**FRAMEWORK** was judged  
**NUMBER 1**

See why at your local computer dealer.

Get a demonstration of this easy to learn and easy to use program. It offers word processing, spreadsheet, database, graphics and communications in a single integrated package.

For the IBM PC and compatibles. Requires dual 360K floppy disk drives, monochrome monitor. Recommended 384K RAM.

Distributed by: **arcompact**

Phone: (071) 393-309  
P.O. Box 852  
HAMILTON

**IBM** is a regd. Trade Mark of International Business Machines  
**Symphony** is a regd. Trade Mark of Lotus Development Corporation  
**Open Access** is a regd. Trade Mark of Software Products International  
**Framework** is a regd. Trade Mark of Ashton-Tate

data into a computer line and allocate a number just as though you had typed it in yourself.

This is done in two parts. In line 85, the numerical data is turned into string data (B into B\$, C into C\$) and together with alpha data (A\$) formed into a portion of a line which, when printed, will hold all input data. Then in line 105, the computer adds a number (X) which it found when the program was first run at line 200.

Thus, when the program is first run, the first line number it will make will start with 201 and each time after that the computer's self-generating line numbers will go up by one.

Most business packages retain input data inside the computer in the form of strings — which is all very nice for the computer but totally invisible to the operator.

Many small business owners with whom I have discussed computers find the idea of their valuable data being held inside a computer so that they can't easily see it does not inspire total confidence in the machinery.

Getting the computer to manufacture a listing of the input data in a simple form that can be easily altered appears to overcome some reluctance to use these modern business tools at the small company level.

Line 110 is the last in the input section and breaks out of the program to leave the current manufactured line on screen ready for a press of the CR key to place it in the program listing in the same manner as any other line number.

After compiling the required item and price information, say, to prepare a tender for a house alteration or a fencing job or similar list of items and prices, the next step would be to add up the individual prices to obtain a total.

This is done by break run 115. The computer will start at line 115 and print out on the screen each item, price, and quantity together with a subtotal, and at the end of the list of items, a grand total.

The user can then determine if the total price would be satisfactory for a competitive tender and if not, examine the listing of the items to see where any prices can be reduced. Having decided to alter an item price or quantity or both, another run 115 will produce an amended price which may be closer to the target price.

Save the program to tape and you have a complete record of the items, prices and quantities for a particular job, contract or tender. The program shows data in lines 201 to 207 with an end in line 999.

The gap between 200 and 999 can be filled with data so there is plenty of room for a fairly large list of items.

There is always the risk with cassette storage that the power fails right at the end of a long list of valuable data. The only way to overcome this is to save the program with the newly written data at regular intervals.

There are three aspects in the program which you may not have seen before.

An input line will collect everything in the screen line. If you want to have a series of headings, it is necessary to print them in the correct position first, then over-print them with the same heading in the input command.

This example will help.  
10 CURSOR 0,10:PRINT "ITEM"  
20 CURSOR 0,10:INPUT "ITEM";K\$

The input "item" fits exactly over the print "item" so you don't see the change from one to the other.

A small routine in line 105. Say you want to incorporate the variable, P, into a character string, X\$. You can't put it in directly with X\$=P because the computer will say type mismatch error and will not accept the variable. The correct method is to use X\$=STR\$(P) now P is incorporated into X\$.

But there is a small problem. Try this to see the problem (use direct mode):

```
CLS:P=5:X$=STR$(P):PRINT X$
Press CR. When X$ is printed it will show 5 but it will be one position away from the left-hand screen edge. If you ask for the length of X$ with
L=LEN(X$):PRINT L
```

You will get L as 2. The string is 2 long and it is away from the screen edge. The answer is that STR\$( ) puts a space in front.

This can sometimes be very inconvenient because numbers won't line up as you would expect them to. It can also lead to difficulties in knowing exactly where P or any other STR\$( ) number is in a long string. It's easy enough to overcome as long as you know what the problem is.

The string has a length of 2 and the left-hand character is a space, we need only the right character. This is done by: X\$=STR\$(P):L=LEN(X\$):X\$=RIGHT\$(X\$,L-1)

This works for any size variable. In line 120, there is a standard for/next routine for Y=1 to 1000 except that if the computer sees "end" the loop counter, Y is made to = 1000 and then GOTO the line after next which is line 145.

When you set up a for/next loop, the computer makes a pile of numbers and keeps then in a loop stack. As each pass around the loop is completed, a new number is pulled off the stack. When all numbers are used up, the stack is empty and the computer moves on to the next instruction.

However, if the stack is not emptied — as would be the case if it met "end" after say only two passes around the loop — there would still be a big pile of numbers left on the stack and this could create a possible stack management problem for the computer. Clearing the stack if a loop is exited prematurely should stop this.

The number formatting routine starting at line 170 ensures all numbers print neatly with the decimal points lined up. Each subtotal has a capacity of \$99999.99 and the grand total capacity of \$999999.99. The subroutine will not cope with numbers with more than two digits to the right of the decimal point such as \$19.346. Such numbers can be

inadvertently input at the input module and a suitable trap to filter out the third number is like this:

```
170 S=INT(S*100+.5)/100:S$=STR$(S):ETC.
```

The number, 19.346 multiplied by 100 equals 1934.6 plus .5 equals 1935.1 INT(1935.1) (short for integer), takes only whole numbers. So the number is now 1935 and divided by 100 equals 19.35, \$19.346 becomes \$19.35.

The computer does get a little slow with the number formatting routine and adding the trap slows it down even further. I would try to put the trap somewhere in the program where a slight delay would hardly be noticeable.

Can you figure out how to test B or C for excess decimal numbers, and if either or both fail the test how to trim them to the right size before the formatting routine'?

Next month, I will deal with putting names into alphabetical order.

```
10 REM<<< READ NUMBER OF DATA ITEMS >>>>>>>
15 CLS:GOSUB200:INPUT"PRESS D + CR ";K
$:IFK$<>"D"THEN15: REM
20 REM<<< SET UP INPUT MODULE >>>>>>>>>>>>
25 CURSOR0,2:PRINT"DATA ENTRY MODULE":
CURSOR8,3:PRINT"-----"
30 PRINT:PRINT"NUMBER OF ITEMS SO FAR
=" ;X-201
35 CURSOR0,9:PRINT"ITEM":PRINT"
-----":PRINT"PRICE":PRINT"
-----":PRINT"QUA.":PRINT"
-----"
40 CURSOR0,9:INPUT"ITEM ";A$
45 CURSOR0,11:INPUT"PRICE ";B
50 CURSOR0,13:INPUT"QUA. ";C
55 CURSOR0,17:PRINTCHR$(5):PRINTCHR$(3
0);"COST $";B*C: REM
60 REM<<<<<<<<<< CONFIRM INPUT >>>>>>>>>>>>
65 CURSOR0,20:INPUT "Y OR N ? ";K$:IFK
$="N"THENCURSOR0,20:PRINTCHR$(5):GOTO
25
70 IFK$<>"Y"THEN65: REM
75 REM<<< IF INPUT ZERO >>>>>>>>>>>>>>>>>>
80 IFB*C=0THENCURSOR0,20:PRINTCHR$(5):
GOTO 25
85 B$=STR$(B):C$=STR$(C):T$=A$+" "+B$+
"+C$: REM
90 REM<<< CLEAR TOP OF SCREEN >>>>>>>>>>>>
95 S$="
":CURSOR0,0:PRINTS$:PRINTS$:PRINTS$
100 REM<<< MAKE LINE NUMBERS >>>>>>>>>>>>>>>>>>
105 X$=STR$(X):L=LEN(X$):X$=RIGHT$(X$,
L-1):CURSOR0,2:PRINTX;" X=X+1:DATA";X$
;" ";T$
110 PRINT"RUN":PRINT"PRESS CR KEY":CUR
SOR0,0:STOP: REM
115 REM<<< READ AND ADD UP DATA >>>>
120 RESTORE:ST=0:T=0:FOR Y=1 TO 1000:R
EAD A$,B,C:REM<ITEM,PRICE,QUANTITY>
125 IF A$="END"THENY=1000:GOTO145
130 S=B*C:GOSUB170
135 PRINTA$;B;C;TAB(27);" ";TAB(28);S$
:S=VAL(S$):T=T+S
```

# C16 & Plus 4 — a case of smart marketing

By Paul Crooks

Excellent Commodore 16 sales in Britain and other countries indicate Commodore has launched another home computer success story.

Commodore has done it by intelligently selecting the computer markets in which to launch the C16.

The C16 won't be released on the huge US market simply because with the Commodore 64 (with all its features and support base) selling for under \$150, the C16 would have to be given away to compete.

So Commodore has chosen to release the C16 only on markets where it has a strong price/performance margin over competing computers and other Commodore models.

This wily piece of marketing seems to have caught many correspondents out, including Steven Darnold who, in this column last month, stated "prospects in 1985 look decidedly gloomy" for the C16.

Certainly, the C16 won't be a phenomenal success like the C64. But in its selected markets, it should do very nicely and at the same time, increase Commodore's dominance of the low end computer market.

For example, in New Zealand the C16 now sells at \$395 which is at least \$200 cheaper than any of its nearest competitors such as the Electron, Atari range and Spectrum Plus (Not the same price as suggested in last month's

column.)

It has an enhanced BASIC, compatibility with existing Commodore peripherals and has been launched with more software (about 50 titles and a lot more coming from UK software houses) than many new home computers.

With its price tag and these features, the C16, as Rob Fullerton stated in his full review in the February issue of *Bits & Bytes*, is aimed at the educational user or first computer user (which is why Commodore calls it the learning machine) and in those markets "it will take a lot of beating."

The future for the C16's big brother, the Plus 4, is still unclear as it has only recently been released overseas as well as New Zealand.

But again the Plus 4 has been aimed at specific target markets in specific countries.

Commodore calls it the productivity machine because of its built-in business software (word processor, spreadsheet, graphics and file manager) and 60K of user RAM.

Combine this with a price tag of \$895 and it is clear this computer has been released in New Zealand because it will appeal to the mass of owner-operated and small businesses looking for computer power at the lowest possible price.

Whether the built-in software will turn out to be sophisticated enough is up to the user to decide but the programs are fully interactive (you can switch from one to another for example to include a graph in a letter on the word processor), a facility which software provided with many other costlier machines lack.

Other proven software such as Easy Script and Superbase is also now available on the Plus 4.

A full review of the Plus 4 will appear in the May issue).

Rather than not having "a clue what to produce," as Steven Darnold asserted, Commodore has clearly followed the same marketing strategy that the large car manufacturers have followed for years — make a number of different

models to suit different markets, from small city run-arounds through family sedans to vans and trucks.

In Commodore's case, that product line has been extended by the release of the C16 and Plus 4 and will be largely completed with the release of its IBM-compatible PC computer here in the next month.

It is unlikely Commodore computers will come to dominate every computer market. But then General Motors doesn't dominate every car market — and its financial results are pretty healthy all the same.

## C64 manager

Commodore's database for the C64, The Manager, is a program designed to keep track of inventory, personnel, accounts payable, sales or accounts receivable. It is billed as a comprehensive electronic filing cabinet. Commodore reports an American college keeps a mailing list of 4000 names on the database.

## Commodore 64 writers

*Bits & Bytes* is expanding its coverage of the Commodore 64 and we would like to hear from C64 owners interested in writing regular or semi-regular articles.

We are looking for articles on:

- Original programs and utilities
- Hardware modifications
- Reviews of software
- Any other hints or information helpful to C64 owners.

Please write giving details of experience with the C64, how regularly you could contribute articles and any ideas you may have to:

The Editor, *Bits & Bytes*, Box 9870, Newmarket, Auckland.

## SEGA

```

140 NEXTX
145 S=T: REM
150 REM << FORMAT AND PRINT TOTAL >>
155 GOSUB170 :PRINT TAB(28);"-----"
":PRINTTAB(22);"TOTAL ";S$:PRINT
160 INPUT "PRESS CR KEY ";K$:CLS:GOTO
115
165 REM<SUBROUTINE TO FORMAT NUMBERS>
170 S$=STR$(S):L=LEN(S$):FORX=1TOL:IFM
ID$(S$,X,1)=". "THEN180
175 NEXTX:S$=S$+".00":GOTO185
180 IFX=L-1THENS$=S$+"0"
185 FORK=1T09-X:S$=" "+S$:NEXT:L=LEN(S
$):S$=RIGHT$(S$,L-2):RETURN: REM
199 REM <<<< DATA >>>>>>>>>>>>>>>>
200 X=201
201 X=X+1:DATA201 POSTS, 123.6, 11
202 X=X+1:DATA202 BATTERNS, 2, 244
203 X=X+1:DATA203 FLASHING, 1445, 1
204 X=X+1:DATA204 WIRE, 10, 2
205 X=X+1:DATA205 POSTS, 187, 10
206 X=X+1:DATA206 FOOTINGS, 110, 10
207 X=X+1:DATA207 STRAINERS, 23, 2
999 DATA END,0,0
1000 RETURN:REM<< RETURN TO LINE 10 >>
    
```

## SERVICE OF COMMODORE COMPUTERS

WE REPAIR: C64 SX64 VIC20 1515 1520 1525 1540 1541

ALIGNMENT OF DISK DRIVES

Grundmann Electronic Service & Development Ltd

P.O. BOX 143 WAIKANAE PH. (058)34291

# Machine language to data statement converter

By William Mackay

This utility, aimed at the serious Commodore 64 user, is a machine language program which will produce DATA lines from numbers in memory such as machine language programs. This means a routine in memory can be converted into a form which allows other users to type it in from a listing.

The routine uses addresses 02B0h to 02BDh and the cassette buffer for data storage, so any routines you may have in these areas will have to be shifted.

Type in the program as listed, save it on tape, and run it. The routine will be POKEd into place. Then NEW it, and enter SYS 49505. You will be asked for four numbers, which you must enter as four-digit hexadecimal: the start address and end address of the routine which you want converted to DATA lines, and the starting line number and life number increment of the DATA lines.

All these numbers must be entered as four-digit hexadecimal numbers, for

example 000A for 10. After the fourth correct input, you will be told how many DATA lines have been created. The BASIC loader used to POKE this program into place can also be used to POKE your new DATA lines into place if you assign the variable BYTESDIV16 with one less than this value. The data is created in lines of 16 bytes followed by a MOD 16 checksum, and the whole block is terminated by the high and low bytes of a MOD 65536 checksum.

To locate this routine in a different memory area, SYS base+718 will correct all absolute addresses, and SYS base+353 will run it.

If the sight of such a large amount of machine language data is too much for you, a copy on cassette can be obtained by sending \$4 to: William Mackey, 91 Songer St, Stoke, Nelson.

# Choosing a Payroll System

Read this before you decide

- The T.C.S. PAYROLL provides detailed reporting on each employee, detailed reports for each pay run, detailed reports for employers for M.T.D. and Y.T.D. totals.
- The T.C.S. PAYROLL is extremely flexible providing for multiple hourly rates, unit rates, extras and deductions.
- The T.C.S. PAYROLL calculates all tax deductions and retains totals for quick, accurate printing of IR12 tax forms.
- The T.C.S. PAYROLL provides for both active and non-active employees.

- The T.C.S. PAYROLL allows for a mixture of different pay frequencies between employees.
- The T.C.S. PAYROLL calculates cash breakdown and banking splits.
- The T.C.S. PAYROLL provides for rounding of pay if required.
- The T.C.S. PAYROLL was completely written in N.Z. and is fully supported in N.Z.
- The purpose of this Payroll system is to provide quick, accurate Payroll calculations, keep accurate records of employee totals and retain employer totals for necessary tax returns.

what you've been looking for?

**\$499**  
at only

there really is no choice!  
**T.C.S. PAYROLL**

FOR FURTHER INFORMATION CONTACT:—  
THAMES COMPUTER SERVICES,  
P.O. BOX 527 THAMES N.Z.  
PH (0843) 86 893

OR RETURN COUPON  
TO ABOVE  
ADDRESS

NAME ADDRESS

PH: DEALER ENQUIRIES WELCOME

**SPECIFICATIONS**

- Runs under MS-DOS 2. Available for IBM PC and compatibles also Sanyo 550 series (Commodore versions available)
- 128k memory for 200 employees
- 256k memory for 320 employees
- Hardware requirements:
  - Minimum 128k RAM Micro Computer (MS-DOS 2)
  - One 360k Disk Drive
  - 80 column printer

Thames Computer Services  
A division of James Electronics Ltd

```

0 GOTO20
1 *****
  x                                     x
3 x      MACHINE CODE TO BASIC        x
  x                                     x
4 x      DATA STATEMENT PROGRAM      x
  x                                     x
5 x      WRITTEN BY :                  x
  x                                     x
6 x      WILLIAM MACKAY                x
  x                                     x
7 x      OCTOBER 1984                  x
  x                                     x
9 *****
10 REM READ MC,POKE INTO MEMORY
20 BASE=49152:BYTESDIV16=59
22 REM BASE=START ADDRESS FOR ROUTINE
26 REM BYTESDIV16=NO OF FULL DATA LINES
30 BY=BY-1:S=0:PRINT"PLEASE WAIT WHILE M
  C. LOADED"
40 FOR J=BA TO BA + BY*16 STEP 16
50 FOR I=J TO J + 15
60 READ A:POKE I,A:S=S+A:NEXT
70 READ A:S=S-INT(S/65536)*65536
80 IFA<>S-INT(S/256)*256THEN PRINT"ERROR
  IN"INT((I-BA)/16)"TH DATA LINE":STOP
90 NEXT
100 READ A,B:A=256*A+B:REM MOD 64 K CHEC
  KSUM
110 IFA<>STHEN PRINT"TOTAL CHECKSUM IN E
  RROR":STOP
120 PRINT"DATA OK":END
1000 DATA160,00,32,207,255,153,60,03,200
  ,201,13,208,245,192,05,240,126
1010 DATA06,32,210,255,24,144,233,32,210
  ,255,169,00,133,251,133,252,161
1020 DATA168,185,60,03,56,233,48,48,215,
  201,10,48,12,56,233,17,218
1030 DATA48,206,201,06,16,202,24,105,10,
  10,10,10,10,162,04,10,228
1040 DATA38,251,38,252,202,208,248,200,1
  92,04,208,213,164,252,166,251,43
1050 DATA96,169,13,32,210,255,169,76,32,
  210,255,169,79,32,210,255,01
1060 DATA169,67,32,210,255,169,32,32,210
  ,255,32,00,192,134,251,132,125
1070 DATA252,169,13,32,210,255,160,00,32
  ,207,255,145,251,200,201,13,216
1080 DATA208,246,192,02,208,01,00,169,00
  ,145,251,152,56,101,251,133,27
1090 DATA251,144,222,230,252,176,218,160
  ,00,140,183,02,138,41,07,141,28
1100 DATA182,02,138,74,74,74,170,24,240,
  19,248,173,182,02,105,08,207
1110 DATA144,04,24,238,183,02,202,208,24
  5,141,182,02,216,96,173,183,146
1120 DATA02,240,05,105,48,145,45,200,173
  ,182,02,74,74,74,74,24,77
1130 DATA105,48,145,45,200,173,182,02,41
  ,15,105,48,145,45,200,169,209
1140 DATA44,145,45,152,56,101,45,133,45,
  44,02,230,46,160,00,96,117
1150 DATA160,00,165,45,145,34,170,185,46
    
```

```
.200,145,34,133,35,134,34,226
1160 DATA96,24,109,188,02,133,251,172,18
9,02,144,01,200,132,252,160,233
1170 DATA00,177,251,240,06,32,210,255,20
0,208,246,96,160,03,173,177,107
1180 DATA02,170,145,45,173,176,02,136,14
5,45,24,109,178,02,141,176,240
1190 DATA02,138,109,179,02,141,177,02,17
6,31,238,184,02,208,03,238,22
1200 DATA185,02,169,04,101,45,133,45,144
,02,230,46,169,131,160,00,52
1210 DATA145,45,230,45,208,02,230,46,96,
169,62,32,01,193,104,104,228
1219 REM ****
1220 DATA96,169,96,141,188,02,169,194,14
1,189,02,169,00,32,01,193,218
1221 REM ↑↑↑(TOP LINE),START OF MAIN
ROUTINE
1222 REM
1230 DATA32,00,192,134,36,132,37,169,14,
32,01,193,32,00,192,134,12
1240 DATA253,132,254,169,26,32,01,193,32
,00,192,142,176,02,140,177,141
1250 DATA02,169,51,32,01,193,32,00,192,1
42,178,02,140,179,02,169,89
1260 DATA00,141,184,02,141,185,02,141,18
0,02,141,181,02,165,45,56,121
1270 DATA233,02,133,45,133,34,165,46,233
,00,133,46,133,35,32,28,16
1280 DATA193,169,16,133,33,160,00,177,36
,170,230,36,208,02,230,37,54
1290 DATA24,109,180,02,141,180,02,144,03
,238,181,02,32,151,192,32,131
1300 DATA190,192,198,33,208,225,174,180,
```

```
02,32,151,192,32,190,192,198,216
1310 DATA46,160,255,169,00,145,45,230,46
,32,240,192,32,28,193,166,147
1320 DATA37,228,254,48,188,208,20,166,36
,240,182,165,253,10,144,04,26
1330 DATA138,10,144,173,202,228,253,48,1
68,160,00,174,181,02,32,151,42
1340 DATA192,32,190,192,174,180,02,32,15
1,192,32,190,192,198,46,160,149
1350 DATA255,169,00,145,45,230,46,160,01
,145,45,136,145,45,32,240,196
1360 DATA192,169,02,24,101,45,133,45,144
,02,230,46,169,13,32,210,217
1370 DATA255,173,185,02,174,184,02,32,20
5,189,169,85,32,01,193,96,146
1380 DATA83,84,65,82,84,32,79,70,32,77,6
7,46,32,00,69,78,102
1390 DATA68,32,79,70,32,77,67,46,32,00,7
0,73,82,83,84,32,05
1400 DATA66,65,83,73,67,32,76,73,78,69,3
2,78,85,77,66,69,70
1410 DATA82,32,00,73,78,67,82,69,77,69,7
8,84,32,00,76,73,18
1420 DATA78,69,32,78,85,77,66,69,82,32,8
4,79,79,32,76,65,77
1430 DATA82,71,69,13,00,32,76,73,78,69,8
3,32,79,70,32,66,234
1439 REM
1440 DATA65,83,73,67,32,67,82,69,65,84,6
9,68,13,00,169,104,64
1441 REM ↑↑↑ BEGINNING OF RELOCATOR
1442 REM
1450 DATA141,244,03,141,246,03,169,170,1
41,245,03,169,168,141,247,03,250
```

```
1460 DATA169,72,141,248,03,141,250,03,16
9,138,141,249,03,169,96,141,79
1470 DATA251,03,32,244,03,138,24,105,117
,133,34,152,105,00,133,35,52
1480 DATA138,56,233,244,133,251,133,253,
152,233,02,133,252,133,254,162,254
1490 DATA00,160,01,161,34,240,37,24,101,
253,133,253,144,03,230,254,234
1500 DATA24,177,34,101,251,129,253,200,1
77,34,101,252,136,145,253,165,106
1510 DATA34,105,03,133,34,144,02,230,35,
24,144,215,165,251,24,105,218
1520 DATA96,133,34,165,252,105,02,133,35
,165,251,24,105,98,133,253,154
1530 DATA165,252,105,01,133,254,165,34,1
29,253,165,253,105,05,133,253,255
1539 REM
1540 DATA144,02,230,254,165,35,129,253,0
0,107,00,00,241,01,01,18,43
1541 REM CHANGE THIS TO A 96 TO RUN ↑
↑ FROM BASIC (FROM BRK TO RTS)
1542 REM
1550 DATA01,01,03,00,00,09,01,01,03,00,0
0,09,01,01,03,00,76
1560 DATA00,11,01,01,03,00,00,00,00,01,13
0,151,00,03,190,00,23
1570 DATA10,151,00,03,190,00,13,240,00,0
3,28,01,34,151,00,03,82
1580 DATA190,00,06,151,00,03,190,00,20,2
40,00,00,00,00,00,114
1581 REM↑ END OF NECESSARY DATA
1590 DATA141,114
READY.
```

## Racer

By Matthew Ross

In this game, you are a car racer who must drive for as long as possible without hitting other cars or the edge of the road. After five collisions your car is a write-off. For those readers who don't want to type the program in, it is available from:  
Matthew Ross  
Aokautere Drive  
R.D. 1  
Palmerston North  
Send a tape or disk, a self-addressed mailer, and \$3.

```
1 PRINT"(CLR)":HS$="000000"
2 SID=54272:S4=SID+4:N=2:P=0
3 POKES3281,6:PRINT"(CYAN)":PRINT"(C/DN)(C
/DN)(C/DN)(C/DN)*TAB(12)*PLEASE WAIT
...."
5 RESTORE V=53248
6 QS=QS+1
7 IFQS>1 THEN GOSUB 1200:GOTO 20
10 GOSUB 1000
20 POKE V+21,255
30 TI$="000000"
40 Z=PEEK(V+31)
50 Z=PEEK(V+30)
100 SYS820
110 IF(PEEK(V+30)AND1)=1OR(PEEK(V+31)AND1)
=1 THEN GOTO 150
115 SYS820
120 F=PEEK(V):F1=PEEK(V+2):F2=PEEK(V+4):F3
=PEEK(V+12)
125 SYS820
130 IFF1)F THEN F1=F1-2
131 SYS820
```

```
132 F1=F1+1:POKE V+2,F1
134 IFF2)F THEN F2=F2-2
135 SYS820
136 F2=F2+1:POKE V+4,F2
138 IFF3)F THEN F3=F3-4
139 SYS820
140 F3=F3+2:POKE V+12,F3
149 GOTO 100
150 POKESID,0:POKESID+5,9:POKES4,128:POKES
4,129:FORT=1TO150:NEXT
160 POKES4,128:POKESID,0:POKESID+5,6:POKES
ID+24,0:POKESID+24,15
170 CR=CR-1:IFCR)O THEN GOSUB 1250:Z=PEEK(V+3
0):Z=PEEK(V+31):GOTO 100
200 SC$=TI$
210 PRINT"(CLR)":POKE V+21,0
220 PRINT"(HOME)(C/DN)(C/DN)(C/DN)(C/DN)*T
AB(15)*(RVON)
225 PRINTTAB(15)*(RVON) GAME OVER "
230 PRINTTAB(15)*(RVON)
235 PRINT"(C/DN)(C/DN)(C/DN) YOUR
SCORE WAS ";SC$
240 IFC$)HS$ THEN HS$=SC$
300 PRINT"(C/DN)(C/DN)(C/DN)*TAB(9)" <SPAC
E> TO PLAY AGAIN"
310 GETA$:IFA$(")" THEN GOTO 310
320 CR=5:PRINT"(C/UP)
":GOTO 2
999 END
1000 DATA00,00,CE,03,DO,EE,05,DO,EE,07,DO,
EE,09,DO,EE,0B,DO,EE,0D,DO,EE,0F,DO
1010 DATAEE,05,DO,EE,0D,DO,EE,0F,DO,EE,0B,
DO,EE,0D,DO,EE,0D,DO
```

```
1020 DATA00,00,A5,C5,C9,07,F0,0A,C9,02,F0,
18,C8,C0,01,DO,FB,60,CE,00,DO
1030 DATAAD,00,DO,C9,1E,DO,F0,A9,1E,8D,00,
DO,4C,69,03,EE,00,DO,AD,00,DO,C9,B4
1040 DATADO,DE,A9,B4,8D,00,DO,4C,69,03
1050 L=820:FORT=1TO95
1060 READA$:C=LEN(A$):A=ASC(A$)-48:B=ASC(R
IGHT$(A$,1))-48
1070 N=B+7*(B)9)-(C=2)*(16*(A+7*(A)9))
1080 IFN<0ORN>255 THEN PRINT"???" :END
1090 POKEL,N:TT=TT+N
1100 L=L+1:NEXT
1110 FORP=12288TO12350:READQ:POKEP,Q:NEXT
1115 V=53248
1120 POKE V+28,255:POKE V+37,0:POKE V+38,14
1130 FORT=2040TO2047:POKEI,192:NEXT
1150 REM ### CAR DATA ###
1160 DATA0,0,0,0,0,0,0,0,0,168,0,2,170,0
,0,168,0,1,169,0,1,153,0,0,184,0
1170 DATA0,184,0,1,169,0,1,169,0,1,169,0,0
,168,0,2,170,0,10,2,128,0,0,0,0,0
1180 DATA0,0,0,0,0,0,0,0
1200 PRINT"(CLR)(C/DN)(C/DN)(C/DN)(C/DN)(C
/DN)":POKE V+21,0
1210 PRINT"(RVON) (
RVOF)"
1220 PRINT"(RVON) R A C E R (
RVOF)"
1230 PRINT"(RVON) (
RVOF)"
1235 PRINT"(C/DN)(C/DN)(C/DN)(C/DN)(C/DN)"
TAB(8)"HIT (SPACE) TO START"
```

To page 92

# Very de-Scribe-able!

By Alex and Fred Wong

Good news for all Apple owners and users. Apple Computer's Texas manufacturing plant has built its two millionth Apple II, and with an alltime production high of another one every seven seconds, it's no wonder income and profits are at record levels too.

Now here's the bad news. *Softalk* magazine for the Apple II has finally succumbed to the rough seas of high finance, taking to the bottom with it *Softalk* for the IBM PC and that great magazine for the Lisa and Macintosh, *St. Mac*. And my subscription had six months to run too!

Following the introduction of the Apple IIc computer late last year for New Zealand's business market, a leading national packaging company, Kiwi Packaging Ltd, has bought a number of IIc packages to acquaint its top management with the potentials and limitations of the multi-terminal, on-line computer system. Managers have volunteered to take home an Apple IIc for three months to familiarise themselves with word processors, spreadsheets, databases and business graphics. Hard homework for anyone!

To extend the IIc's product range even more, Apple has released the Scribe, an economic, friction/tractor, six-colour, low volume, thermal transfer printer with a serial interface, designed primarily for use with the IIc.

## Hardware and installation

The Scribe arrived in its shiny red box all bright and gleaming and raring to go, so we whipped it out with the minimum of preliminary. The colour is naturally the IIc's Apple Fog (really very white!) except for the translucent black printer cover (only the middle printer lid tilts up.)

The buttons on the top include power, select (on-line), letter (the hardware switch between the two different modes of printing) and the line feed/form feed switch. At the back is a panel covering the six configuration dip switches. The power plug comes out the right hand side and the serial connector on the left, leaving the rear free for paper feed which comes from the forward tilting paper stand that can (and does) sit beautifully under the Scribe, and holds about 40 fan-feed pages.

To attach the Scribe to the IIc is simplicity itself with the optional accessory kit. Only the RS232C cable has to be plugged in. To attach it to an Apple II Plus or IIe computer, you need the Scribe accessory for the IIe

The rain in Spain falls mainly on the plain.

The rain in Spain falls mainly on the plain.

The rain in Spain falls

The rain in Spain falls mainly on the plain.

The rain in Spain falls

A Scribe print sample



An illustration from the Scribe

which comes with the Super Serial interface card, cable and manual. Preferably install it into slot 1.

## Printing — or maybe 'scribbling'

The Scribe "incorporates the latest in non-impact technology" (to borrow a phrase!) to use the thermal transfer printing method. Don't cringe at that inde-Scribe-able word; it's not really a thermal printer at all and needs no special paper. Thermal transfer means the head actually sends electricity via 24 elements to heat the carbon film ribbon to release ink onto the paper in a controlled fashion; traditional

impact dot matrix printers rely on physical contact between head, ribbon and paper.

The Scribe has two modes of operation — draft (in a 9 x 14 matrix) and letter (in huge 12 x 15 matrix). Fred and I are about to try both. In draft mode, it will print at 80cps (characters per second) for a standard 10cpi (characters per inch), a compressed 17cpi or a double width 5cpi. The text appears solid and well formed although still dot matrix. In letter mode (obtainable by the hard switch or through software control), it will print 10cpi or 5cpi at 50cps. The astoundingly good quality of this print is, in Fred's words, "something to write home about!"

In either mode, printing is uni-directional and it prints true descenders as well as subscripts, superscripts and underline. It won't handle italics or a user-defined character set but has seven international character sets as well as full graphics capabilities. The graphics mode has a maximum resolution of 160 x 144 dpi (that's . . . dots per inch), which means 1280 dpl (dots per line!).

Paper may be any kind from letter quality



## Printer summary

|                          |   |
|--------------------------|---|
| <b>Name:</b>             | Scribe  |
| <b>Manufacturer:</b>     | Apple Computer Inc.   |
| <b>Type:</b>             | Non-impact thermal transfer dot matrix                          |
| <b>Print speed:</b>      | 80cps in draft mode; 50cps in letter mode                       |
| <b>Print head:</b>       | 24 elements, in-line vertical                                   |
| <b>Chars/line:</b>       | 40, 80, 136   |
| <b>Graphics:</b>         | 160 x 72 dots per inch (1280dpi)                                |
| <b>Max. paper width:</b> | 254mm (10 in)   |
| <b>Paper feed:</b>       | Tractor or friction   |
| <b>Ribbon:</b>           | Cartridge containing single strike carbon film, black or colour |
| <b>Interface:</b>        | RS-232C serial interface  |
| <b>Data transfer:</b>    | 1200 or 9600 baud   |
| <b>Weight:</b>           | 6.4kg   |
| <b>Price:</b>            | \$845   |

(Review model from the Byte Shop, Fort St, Auckland).

single sheet, computer fan fold, transparencies to newsprint rolls. But as a thermal transfer printer, the quality of print depends (for better or worse) to a large extent, on the quality of paper used. Thick bond paper is a no-no while smooth (Xerox 4024 copier) paper is recommended.

Another Scribe innovation is the six-colour printing capability achieved by a special colour ribbon (yet to be released here). This ribbon has lengths of the three primary colours in sequence and mixed to give the desired shade. The black ribbon, which we estimate should last about 40 pages, costs an extortionate \$25, although the cost should drop as demand rises.

### Excellent piece of hardware

The Scribe manual for the IIc is indexed,

concise and clear, well decked with illustrations and examples. It is separated into a user's guide, which contains everything needed to install, operate and care for the Scribe, and a reference section which provides information on control codes, commands, graphics printing and hardware connections.

The only inexplicable "undocumented feature" of the manual is that instead of the first page of contents for the reference section, there is a list of figures and tables for the Apple colour plotter!

The Scribe printer is an excellent piece of peripheral hardware, not only for the IIc or the other Apple IIs but for any computer equipped with a serial RS-232C interface. If the task is low volume (about 60 pages a month) printing and near letter quality print is desirable, it would be an excellent choice.

The Scribe is valued at \$845 and, while we've got you by the pocket, so to speak, the price of a IIc introductory system, which includes the IIc, monitor and stand is \$3760.

### Short catalogue

A new short form catalogue of digital process instrumentation has been released by International Microtronics Corporation through its New Zealand distributors. The catalogue lists digital instruments for the recording and/or controlling of pressure, temperature, weight, current loop, flow, rate, VAC, VDC, RMS, resistance, time, frequency, event, interval, ratio etc. The instruments are claimed to interface with any transducers and to be IBM PC compatible.

Copies of the catalogue are available from Computer Store. (P.O. Box 31-261, Milford, Auckland 9).

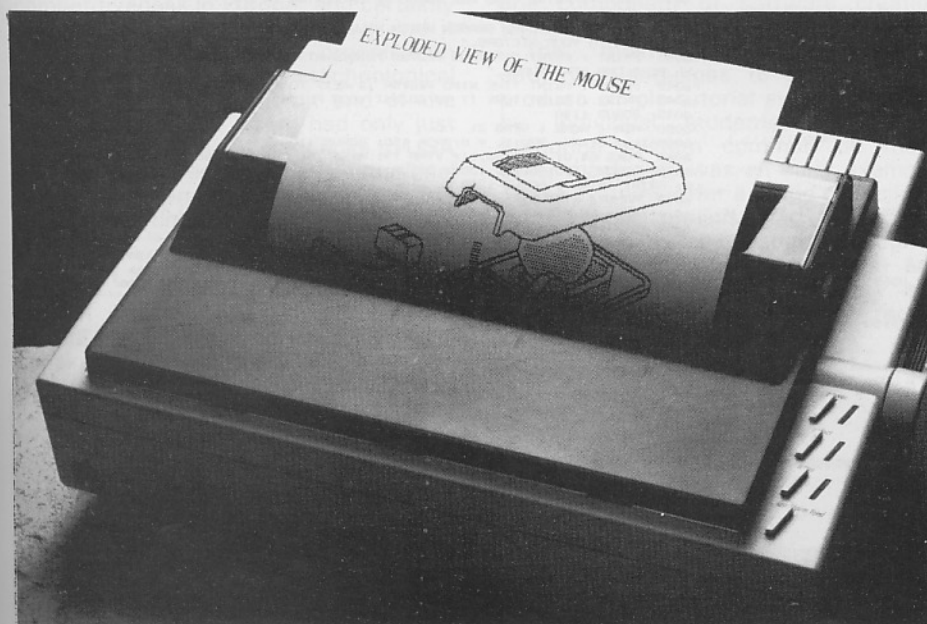

The Scribe printer

# Congratulations!

Our "Hands-On" holiday competition winner is S. Vaultier, of Foxton, with his program, "Vectors". We thought this one the best because it promotes the subject in a clear and interesting way.

```

1 IF PEEK (103) < > 1 OR PEEK (104) < > 64 THEN POKE 103,1: POKE 104,64: P
OKE 16284,0: PRINT CHR$ (4);"RUNVECTORS"
2 HOME : PRINT "THIS PROGRAM NEEDS A SUPPORT PROGRAM": PRINT : PRINT "FROM THE
APPLE SYSTEM MASTER (OR): PRINT : PRINT "PROGRAM EXAMPLE DISK"
3 PRINT : PRINT "AN EXPLANATION HOW TO SAVE THE PROGRAM": PRINT : PRINT "IS IN
THE PROGRAM LISTING."
4 PRINT : PRINT : PRINT : PRINT " " "": GOSUB 1150
8 REM BY S.VAULTIER 1985: WHEN TYPING, LINES 2 - 29 CAN BE LEFT OUT. SAVE PR
OGRAM AS "VECTORS"
10 REM *****
12 REM THIS PROGRAM USES A SUPPORT FILE TAKEN FROM THE SYSTEM MASTER TO GEN
ERATE LETTERS ON THE HI-RES SCREEN
14 REM THE FILE IS CALLED CHARGEN IN THE "VECTORS" PROGRAM
16 REM **** STEPS TO SAVE CHARGEN ****
18 REM (1) RUN THE "APPLEVISION" PROGRAM
20 REM (2) PRESS [RESET] WHEN THE GRAPHICS START
22 REM (3) INSERT THE "VECTORS" DISK, TYPE BSAVE CHARGEN,A#847,L#346
24 REM *****
26 REM N(I)-NOTES X(I),Y(I)-COORDS OF AIRPORTS M(I)-ERROR MESSAGES
27 REM SUBROUTINES:1100-DRAW GRID 1140-PRESS KEY 1200-POKES FOR TEXT DISPLAY 1
250-DOT 1300-PACIFIC 1500-BRACKETS 1530-INPT ROUTINE 1600-EXAMPLE ROUTINE 1700-G
ENERATE RANDOM X1,Y1
28 REM 1750-PLT X CPT 1760-PLT Y CPT 1770 DRAW VECTOR 1780-REMOVE VECTOR CPT
S
29 REM CHARGEN AT A#847 MUSIC GENERATOR AT A#300 PROGRAM STARTS A#4000
30 DEF FN R(X) = 1 + INT ( RND (1) * X)
40 DATA 173,48,192,136,208,5,206,1,2,240,9,202,208,245,174,0,3,76,2,3,96,195,17
1,152,144,128,114,102,96
48 FOR X = 770 TO 790: READ Y: POKE X,Y: NEXT
50 FOR I = 1 TO 8: READ N(I): NEXT
52 DATA AUCKLAND,110,150,NORFOLK,20,60,NOUMEA,20,20,SUVA,130,10,TONGA,180,20,
COOK IS.,240,30,AUCKLAND,110,150
53 FOR I = 1 TO 7: READ A(I): READ X(I): READ Y(I): NEXT
54 DATA YOU LAND IN THE SEA AND DROWN!,YOU'RE DEAD..DEADHEAD,CLUMSY DAF..A NAVI
GATION ERROR,TWIT..PLANES ARE EXPENSIVE,OH YOU DOZY TWIT,PICKLE- BRAINED NERD,
55 FOR I = 1 TO 6: READ M(I): NEXT
60 PRINT : PRINT CHR$ (4);"BLOADCHARGEN"
100 HGR : HCOLOR= 3
150 GOSUB 1600
200 GOSUB 5000
300 GOSUB 6000
400 HOME : VTAB 21: PRINT "QUIT?": GET A$: IF A$ < > "Y" THEN GOSUB 6050
999 END
1100 FOR I = XL TO XR STEP 10: FOR J = YL TO YR STEP 10: HPLT I,J: NEXT : NEXT
: RETURN : REM GRID
1140 VTAB 23
1150 INVERSE : HTAB 10: PRINT "PRESS A KEY.": NORMAL : GET A$: RETURN
1200 HCOLOR= 0: FOR I = 250 TO 270 STEP 10: FOR J = 120 TO 150 STEP 10: HPLT I
,J: NEXT : NEXT : HCOLOR= 3: RETURN
1250 HPLT XS = 1,YS = 1 TO XS = 1,YS = 1 TO XS + 1,YS + 1 TO XS + 1,YS = 1
1260 RETURN : REM ROUTINE TO PLACE SOLID DOT AT VECTOR START
1300 POKE 54,0: POKE 55,11
1350 HPLT 107,150 TO 103,130 TO 106,128 TO 101,120 TO 109,120 TO 108,127 TO 11
3,132 TO 109,151
1360 HPLT 117,150 TO 120,145 TO 121,150
1365 XS = 110:YS = 151: GOSUB 1250
1370 HPLT 0,0 TO 6,2 TO 20,12 TO 22,20
1380 HPLT 18,20 TO 16,20 TO 4,10 TO 0,3
1385 XS = 20:YS = 21: GOSUB 1250
1390 VTAB 3: HTAB 5: PRINT "NOUMEA"
1400 XS = 20:YS = 60: GOSUB 1250
1410 VTAB 8: HTAB 5: PRINT "NORFOLK"
1420 HPLT 127,0 TO 125,7 TO 132,10 TO 130,0 TO 127,0
1430 XS = 130:YS = 11: GOSUB 1250
1440 HTAB 20: VTAB 1: PRINT "SUVA"
1445 XS = 180:YS = 20: GOSUB 1250
1450 XS = 240:YS = 30: GOSUB 1250
1460 VTAB 3: HTAB 27: PRINT "TONGA"
1470 VTAB 4: HTAB 36: PRINT "COOK"
1480 VTAB 19: HTAB 8: PRINT "AUCKLAND"
1490 RETURN
1500 HPLT 244,115 TO 242,118 TO 242,142 TO 244,145
1510 HPLT 265,115 TO 267,118 TO 267,142 TO 265,145
1520 RETURN
1530 VTAB 22: INPUT "TYPE IN TOP NUMBER ";X1:XI = VAL (X1): IF ABS (X1) > 1
5 THEN HOME : GOTD 1530
1534 IF X1 = 0 AND X1# < > "0" THEN 1530
1540 GOSUB 1750
1550 VTAB 23
1555 INPUT "TYPE BOTTOM NUMBER ";Y1:YI = VAL (Y1): IF ABS (Y1) > 15 THEN H
OME : GOTD 1550
1557 IF Y1 = 0 AND Y1# < > "0" THEN 1550
1560 GOSUB 1760
1599 RETURN
1600 HOME : HGR : VTAB 21: PRINT "THIS PROGRAM SHOWS SOME USES OF VECTORS"
1610 GOSUB 1150
1612 HOME : VTAB 21
1615 PRINT "LETS REVISE THE WAY VECTORS ARE DRAWN.": GOSUB 1150
1620 HOME
1650 FOR K = 1 TO 4
1651 XL = 60:XR = 140:YL = 60:YR = 140: GOSUB 1100: REM GRID

```

```

1652 GOSUB 1500: REM VECTOR BRACKETS
1653 GOSUB 1700: REM RAND NOS FOR VECTOR
1655 GOSUB 1750: GOSUB 1760: REM PRINT VECTOR CPTS
1670 XS = 100:YS = 100: GOSUB 1250: GOSUB 1770: REM DRAW VECTOR
1672 GOSUB 1140: REM PRESS A KEY
1673 HOME : VTAB 21: PRINT "THE TOP NUMBER IS A HORIZONTAL MOVE": HGR : GOSUB 1
100: GOSUB 1500: GOSUB 1250: GOSUB 1750: GOSUB 1140
1674 HOME : VTAB 21: PRINT " ";XI;" MEANS MOVE "; ABS (X1);" SPACES";
1675 IF X1 > 0 THEN PRINT " RIGHT"
1676 IF X1 < 0 THEN PRINT " LEFT"
1677 FOR J = XS TO XS + 10 * XI STEP SGN (X1) * 2
1678 IF INT (J / 10) * 10 = J AND J < > 100 THEN POKE 768,N( ABS (J - 100) /
10): CALL 770
1679 HPLT J,YS: NEXT J: GOSUB 1140: HOME : VTAB 21
1680 PRINT "THE SECOND NUMBER IS AN 'UP/DOWN' MOVE": GOSUB 1140: HOME : VTAB 21
1687 PRINT " ";YI;" MEANS MOVE "; ABS (Y1);" SPACES"; IF Y1 > 0 THEN PRINT "
UP"
1688 IF Y1 < 0 THEN PRINT " DOWN"
1689 GOSUB 1760
1690 GOSUB 1140
1692 FOR J = YS TO YS - 10 * YI STEP - SGN (YI) * 2
1693 IF INT (J / 10) * 10 = J AND J < > 100 THEN POKE 768,N( ABS (J - 100) /
10): CALL 770
1696 HPLT XS + 10 * XI,J: NEXT
1697 GOSUB 1770: GOSUB 1150: HGR : HOME : NEXT
1698 HOME : VTAB 22: PRINT "MORE EXAMPLES? (Y/N)": GET A$: IF A$ = "Y" THEN HO
ME : GOTD 1650
1699 RETURN
1700 XI = FN R(8) - 4:YI = FN R(8) - 4
1704 IF X1 = 0 AND Y1 = 0 THEN 1700
1710 RETURN
1750 POKE 54,0: POKE 55,11
1751 HTAB 36: VTAB 16: IF X1 > 0 THEN PRINT " ";XI
1752 IF X1 < 0 THEN PRINT X1
1754 POKE - 16302,0: POKE - 16301,0: POKE 54,189: POKE 55,158
1759 RETURN
1760 POKE 54,0: POKE 55,11
1761 HTAB 36: VTAB 18: IF Y1 > 0 THEN PRINT " ";YI
1762 IF Y1 < 0 THEN PRINT Y1
1765 POKE - 16302,0: POKE - 16301,0: POKE 54,189: POKE 55,158
1769 RETURN
1770 XF = XS + 10 * X1:YF = YS - 10 * Y1: HPLT XS,YS TO XF,YF: IF X1 > 0 AND Y1
= 0 THEN HPLT XF - 4,YF + 4 TO XF,YF TO XF - 4,YF - 4
1771 IF X1 > 0 AND Y1 > 0 THEN HPLT XF,YF + 4 TO XF,YF TO XF - 4,YF
1772 IF X1 = 0 AND Y1 > 0 THEN HPLT XF + 4,YF + 4 TO XF,YF TO XF - 4,YF + 4
1773 IF X1 < 0 AND Y1 > 0 THEN HPLT XF + 4,YF TO XF,YF TO XF,YF + 4
1774 IF X1 < 0 AND Y1 = 0 THEN HPLT XF + 4,YF - 4 TO XF,YF TO XF + 4,YF + 4
1775 IF X1 < 0 AND Y1 < 0 THEN HPLT XF,YF - 4 TO XF,YF TO XF + 4,YF
1776 IF X1 = 0 AND Y1 < 0 THEN HPLT XF - 4,YF - 4 TO XF,YF TO XF + 4,YF - 4
1777 IF X1 > 0 AND Y1 < 0 THEN HPLT XF - 4,YF TO XF,YF TO XF,YF - 4
1779 RETURN
1780 POKE 54,0: POKE 55,11: HTAB 36: VTAB 16: PRINT " ": HTAB 36: VTAB 17: PR
INT " ": HTAB 36: VTAB 18: PRINT " "
1785 POKE - 16302,0: POKE - 16301,0: POKE 54,189: POKE 55,158
1799 RETURN
5000 HGR : HOME : VTAB 21
5001 PRINT "NOW THAT YOU ARE AN EXPERT AT DRAWING": PRINT "VECTORS WE ARE GOING
TO USE THEM TO": PRINT "HAVE A PLANE RIDE ROUND THE PACIFIC."
5002 GOSUB 1150
5003 XL = 0:XR = 270:YL = 0:YR = 150
5004 GOSUB 1100
5006 GOSUB 1300
5007 GOSUB 1780
5008 GOSUB 1500
5009 HOME : VTAB 21
5010 POKE 54,189: POKE 55,158: POKE - 16301,0
5018 FOR I = 1 TO 6: GOSUB 1780: VTAB 21
5020 PRINT "STAGE ";I;" - ";A$(I);" TO ";A$(I + 1);": GOSUB 1530
5030 IF XI < > (X(I + 1) - X(I)) / 10 OR YI < > (Y(I) - Y(I + 1)) / 10 THEN
HOME : VTAB 21: PRINT M$( FN R(6)): GOSUB 1140: POP : GOTD 150
5040 XS = X(I):YS = Y(I): GOSUB 1770
5050 HOME : GOSUB 1140: HOME
5060 NEXT I
5066 VTAB 21: PRINT "YOU ARE ANOTHER LINDBERGH": GOSUB 1140
5070 RETURN
5070 TEXT : HOME
6010 PRINT "THIS IS WHERE IT GETS HARD.": PRINT
6020 PRINT : PRINT "YOU ARE GOING TO BE FLYING IN THE "
6025 PRINT
6030 PRINT "HURRICANE SEASON WHICH WILL REQUIRE YOU": PRINT : PRINT "TO MAKE AD
JUSTMENTS TO YOUR VECTORS."
6040 PRINT : PRINT "IF YOUR VECTOR POINTS AT THE TARGET": PRINT : PRINT "YOU WI
LL BE BLOWN OFF COURSE."
6042 PRINT : PRINT "THE WIND VECTOR IS NEXT TO THE BRACKET."
6043 PRINT : PRINT "USE IT TO ADJUST YOUR FLIGHT VECTOR."
6045 GOSUB 1140
6050 HGR : HOME : VTAB 21
6060 XL = 0:XR = 270:YL = 0:YR = 150: GOSUB 1100
6064 POKE 54,0: POKE 55,11: VTAB 19: HTAB 24: PRINT "WIND": GOSUB 1200
6070 GOSUB 1300: GOSUB 1500: GOSUB 1780: POKE 54,0: POKE 55,11: VTAB 19: HTAB 2
4: PRINT "WIND": GOSUB 1200
6072 HOME : VTAB 21
6074 XW = FN R(3) - 2:YW = FN R(3) - 2: IF XW = 0 AND YW = 0 THEN 6074
6090 XS = 180:YS = 130:XI = XW:YI = YW: GOSUB 1770
6100 FOR I = 1 TO 6: GOSUB 1780: VTAB 21
6110 PRINT "STAGE ";I;" - ";A$(I);" TO ";A$(I + 1);": GOSUB 1530
6120 IF XI + XW < > (X(I + 1) - X(I)) / 10 OR YI + YW < > (Y(I) - Y(I + 1)) /
10 THEN HOME : VTAB 21: PRINT M$( FN R(6)): GOSUB 1140: GOTD 6050
6130 XS = X(I):YS = Y(I): GOSUB 1770
6135 XS = XF:YS = YF:XI = XW:YI = YW: GOSUB 1770
6140 HOME : GOSUB 1140: HOME
6150 NEXT I
6160 VTAB 21: PRINT "WELL DONE!...THESE ARE QUITE HARD": GOSUB 1140
6999 RETURN

```

**Bits & Bytes — the reader-friendly**  
**magazine**

# Authoring language & Acornetti

By Pip Forer

The MX Mouse promised for review is still in customs as I write, being classified and re-classified. Perhaps Ag and Fish have got in on the act too to complicate matters. Whatever the case, we have brought forward the review of authoring utilities for teachers. First of all though, we could hardly pass by without comment on Acorn's financial problems and their eventual solution.

Acorn has been half bought, for an aria if not a song, by Olivetti of Italy. Is this cause for concern? In the long run, it could be argued to be cause for rejoicing (especially if you are not a Pom). Acorn's problems were largely brought upon its own head by inept marketing decisions – drains to a kamikaze assault on the US market, over-stocking of the Electron at least partly related to the delay in providing its expansion options; an attempt to advance too far on too many fronts with its business machines. The cash-flow problems that resulted toppled Hauser and Curry.

Olivetti is a revitalised typewriter firm that produced one of the best 8086 style business machines, capturing 15% of the European market, and then went on to team up with AT&T, the American communications giant (via a 25% AT&T shareholding), to go for a 7% market share in the States in 1985-6. Neither Olivetti nor AT&T has any dealings with the low end, personal or educational markets although AT&T has long been seen as ripe to enter the computer market.

The Olivetti connection gives the Italian firm access to the education market in general, but to Britain in particular. For the Acorn system, it offers two possibilities – an image as a European system, with possible greater competitiveness in Europe, and certainly Italy, if Olivetti looks that way; and it makes it part of a larger organisation with marketing and technological resources at the 16/32 bit end of the market (into which Acorn had only just moved) and with significant links to USA in both key fields. Acorn's educational and home users can look for benefits from this as time passes.

## Great claims

Great claims have been made for tutorial CAI, most of which have remained unfulfilled where teaching goals of any complexity have been involved. However for simple tasks, and particularly for on-going assessment, such systems do offer a fast way to create software. Normally, such software consists of at least four components:

- An editing system to create or modify lesson sessions.
- A delivery system to administer these.
- A branching control system to steer students through appropriate tuition paths – avoid material they already

know, reinforce weak areas etcetera.

- A record keeping system to record student progress, learning paths etcetera.

I got into this area through a data handling in geography course where students came to a lab after attending a lecture a few days before. We wanted to be sure the material in the lecture had been sufficiently absorbed to do lab work. How could we assess this? The answer was to create a multiple-choice assessment unit called ASK. All ASK does is allow the "teacher" to create a series of screens – either simply text or with multiple choice questions. Answers can be selected by a bar menu.

## At the chalkface

Meanwhile, back at the chalk face (and in industrial training), many users are more concerned with how to get a particular piece of teaching software up and running than with high finance. Educational programs are known to be expensive to produce in time terms. It is hard to arrive at meaningful figures for the usual ratio but 100 hours programming to produce an hour's instructional material is quite often mentioned as an average figure. One way to reduce the time taken in creating material is to use an authoring language.

In theory, authoring languages can be produced to create any form of software including simulations with animation. On future machines, integrated packages may appear to do this, and the Small-Talk system is often cited as a likely model for the all-singing-all-dancing authoring environment. However, on current eight-bit units we are usually restricted to systems that handle just one component of software creation (animation utilities, for example).

The most frequently produced authoring languages to date offer to produce simple tutorial systems for use by individual students. PILOT, an authoring system common on many other machines, was an early example. These systems offer a range of facilities from simply administering text pages and multiple-choice questions through to intermingling of text, graphics and sound, control of video imagery and complex student routing and record keeping.

In all cases, the system creates units for administration to students through a lesson-creating editing system that offers considerable gains over traditional languages. The units created by such systems can be used for a variety of purposes – from support in a lab that uses other approaches to computer-assisted learning to single-student use of stand-alone units designed to cover a topic on their own (often termed tutorial CAI).

## How it works

The system took a professional student programmer a few hundred hours to program (at that time no alternatives existed) but it allowed a teacher to produce question and answer sessions very quickly. In terms of our four components, the system works like this:

- The editing is full screen editing working on a screen at a time using teletext mode and allows up to 30 questions per session and nine variable length options per question page, only one of which can be correct. It is robust and simple to use but limited.

- The delivery system presents the questions page by page to the user, who simply needs to know how to use the arrow keys to answer.

- Routing occurs only at the end of the session when the "teacher" gets to set options depending on student performance. These include reviewing or redoing a question set, going to a new question set, running a BASIC program or sending a message to the user. For instance, a good student can be sent straight to a BASIC simulation, a struggling one given a "see me" message.

- Record keeping is in two forms. The cumulative answers for each question go to one file, so the teacher can see where the class in general is in difficulties (or perhaps where his or her questions are badly posed).

Individual records, question by question, are sent to a cumulative text file that can be read by a word processor (where SEARCH can be used to look for particular session or student results and which can be quickly edited down to give reports by class). On the network version, all users can be polled for results

## SPECIAL OFFER

Buy a Dick Smith 'CAT' Computer, Disk Drive and Controller (Normally \$2039.95), and get the EMULATOR CARTRIDGE (worth \$149.95) FREE!!! – Plus, since we prefer round figures, our price to you is just \$2000.00

CALL OR WRITE TO:

**KANE AGENCIES LTD**

304A HARDY ST.  
Ph (054) 84-066  
P.O. BOX 710 NELSON

Orders despatched promptly, FREIGHT FREE. Visa, Bankcard Accepted.

from a central machine. For instance, class feedback or opinion can be monitored easily and quickly.

Although ASK was established as an assessment system in practice it worked as a teaching aid. Students in two labs worked simultaneously on a session, with great benefits from their debate and interchange in trying to answer correctly. They also sought out the units at the end of the course as revision resources. It thus became a simple form of CAI.

However, ASK is a very elementary system. Supporters of true CAI seek

## The sale — another view

Acorn Computers, which made the BBC one of the largest selling computers of its type around the world, has sold a 49.3% shareholding to Olivetti, the Italian electronics conglomerate.

The move is seen as a strategy to allow the company to reduce its dependence on the volatile home computer market and strengthen its place in the world's education and training markets.

It follows media speculation in Britain on the company's future and the suspension of trading in its shares on the London Stock Exchange.

Acorn's New Zealand distributor, Barson Computers NZ Ltd, has welcomed the Olivetti involvement. Says managing director, Doug Pauling:

"The BBC micro has been enormously successful in this country, particularly in the education sector. We welcome not only a new degree of stability in a company which has grown at incredible rates in the last few years but also the creation of a specialist education and training division at the head office in Cambridge."

"One of the four divisions created under a new corporate structure just announced, this group is particularly responsible for the worldwide sale and support of the BBC system, its add-ons and derivatives. Its establishment

## Training courses

The schedule of IAL dealers and users' courses being run at Carrington Tech in Auckland this term is:

Tuesday, April 9: Order processing, debtors inventory.

Wednesday, April 10: General ledger, creditors' ledger.

Thursday, April 11: Job costing, bill of materials.

Tuesday, May 14: Order processing, debtors' inventory.

Wednesday, May 15: General ledger, creditors' ledger.

Thursday, May 16: Job costing, bill of materials.

The full day courses cost \$100 and each intake is limited to 12 people.

much more than ASK offers, including mixed graphics and text and controlled, internal branching. ASK was introduced here only to raise some of the component concepts of CAI systems.

The BBC has already produced two purpose-built systems for CAI that are available in New Zealand - Microtext, from Britain and Proforma, from Waikato University. Both are simple but powerful languages in their own right with considerable extensions for the demanding user. We will consider these in detail later and compare them to PILOT.

ensures education will be given priority long-term at Acorn".

Pauling says existing BBC users in New Zealand can be confident of continuing support for their machine and of its future development.

The Acorn agreement with Olivetti covers not only financial and marketing arrangements but also various aspects of product development and research.

"As an example of the British Broadcasting Corporation's confidence in the machine which carries its name, the corporation has renewed its contract with Acorn for manufacture and development of the micro for a further four years".

## New IBM PC software

IBM has released its most comprehensive family of PC software products with programs that allow an exchange and combination of information from a variety of jobs.

This modular suite of programs allows users to select according to their needs and includes a word processing program with a spelling verification aid, a file program, a reporting assistant to organise and sort files, and a graphing assistant to produce up to four line bar or pie graphs.

The programs have been designed for first-time computer users but will handle sophisticated requirements. Information can be transferred among the different programs — data from the filing assistant can be used with the graphing assistant to generate a graph or chart which can then be inserted in a report of letter prepared with the writing assistant program.

The series includes three sets of pre-defined solutions which can speed up and simplify record keeping and can be used with the IBM PC, the IBM PC XT and the personal computer, all with a minimum of 128K bytes of user memory and a double-sided diskette drive.

## Teach yourself

Teach-yourself disk-based training for Symphony dBASE III, Framework and Macintosh Multiplan has been released here by American Training International, represented by Total Computer Services Ltd, of Dunedin.

The Symphony tutorial has been praised by New Zealand dealers and the first-end users, because it's considered superior to the tutorial that accompanies Symphony and incorporates ATI's latest courseware techniques. These include fast reverse and forward of tutorial screens, instant help and special key assignments.

This version is a two-disk tutorial comprising basic and advanced features.

Prices of ATI modules are \$120 for tutorials on operating systems, BASIC and Apple II modules, with other modules \$185.

## BEANCOUNTER

A number of US distributors are evaluating BEANCOUNTER, an IAL package launched here last year and enjoying some success in Australia as well.

This accounting software package was specifically designed for ease of use, particularly for non-computer users. One of the first commercial applications for the package in New Zealand was with an Auckland engineering consultancy which uses it to produce letters, reports, engineering documents and specifications on a Macintosh.

As well as speeding the flow of technical information through the 25 member office, it has been used to streamline the administration process to keep track of work and clients.

## IBM in China

IBM China has been established as a wholly-owned subsidiary of IBM World Trade Americas/Far East Corporation to conduct IBM's business in the People's Republic of China. The new company, incorporated in USA, has offices in Beijing and Shanghai.

IBM is engaged in several business and technical projects with the Chinese government, and will provide 100 academic computing workstations, including software and Chinese character support, to selected universities in China.

# Beta-base database manager

By Bernard Gunn

Basically, a computer has only three functions: it may be a sophisticated programmable calculator, a typewriter with memory of many pages of text — even whole books, or it may merely be taking the place of a filing cabinet or card index as a store of names, addresses, lists of patients, customers, friends or nuts and bolts. Others may claim a computer's main current function lies in accounting and sending out monthly bills but I believe such activity is below the notice of a gentleman.

In the early days of computing, long lists of data, names and addresses of political party members etc. were stored on reels of 2400ft magnetic tape. Unfortunately, tape stretches somewhat and it was not possible to tell the computer to "reel off 2147 feet and read the name and address stored there". The only way to find name and address number 37,565 was to read off all 37,564 previous ones — an operation that could take several minutes.

When large rigid magnetic disks were first becoming available in the mid to late sixties, they were treated as a very long tape laid in circles. However, some clever person soon developed the idea of recording in an index which track and sector of the disk each record was stored in. So if the computer was asked to show on the screen record number 37,564, it did a mental calculation and came up with the fact it ought to lie on track 72, sector number 15 or whatever. The disk read-head was shot out and the record read off in a few tenths of a second — a great improvement.

Even then, it was sometime — the late seventies in fact — before even cleverer programmers began to construct indexes as to where different records might be located on other bases than serial number — where to find the name Smith as opposed to Aaronsson or Zilog.

Really intelligent readers will have already realised this is the very weakness of the human brain — it can store gigabytes of information if only we could find it again. If I think for several minutes, I may well be able to recall my

Montreal, Canada, telephone number of some six years ago — an entirely useless piece of information. Even then, I may not remember it correctly. It was 343-6830 (I think!). Had I stored it in my Beeb, it would have been recalled in the regulation 0.5 seconds, correct to 12 decimal places.

A program to help a user input data lists, edit, correct, find them again, search for particular names, book titles, or criminal cases, sort them alphabetically into new files, or merge two files into one, is called a database manager. Now, even home computers have them — some are very good indeed; some have some deficiencies.

A database manager for your IBM PC, such as d-BASE III by Ashton Tate, may cost as much as \$1200 and be worth every nickel. A recent database manager written for the Beeb costs only \$85 and it is very interesting to assess whether you are getting only 10% of the capability. This program, called Beta-Base, takes most of the work out of storing your data in your computer. At present, it is limited in capacity to one side of a disk (200,000 characters or about 70 pages). But this is to be extended to two and possibly four disk sides (280 pages).

The first step in creating a file ought to be to name it, then decide on the order and type of data to be put into it. In Beta-Base, this takes place rather oddly in the reverse order. You decide on the size and types of the fields and what they are to be called. You might have a field called "Name", 25 characters long, followed by one called "Telephone No.", of seven digits. Only then are you asked for a name for a whole file and how long it is to be.

If at this stage, there is not enough room on a disk, you would have to delete some old unused files to make room. To do this, you would have to abandon the program and go back to BASIC, unfortunate if you have just typed in names and specifications for 50 fields for a new file. When building up this list, field names are entered at the top of the

screen but appear in a list in the bottom — a neat check on what you are doing.

When you start to enter data however, no indication is shown on how long the field has been set to. If you have set a field called "COMMENTS" to 100 characters long, you do not know when space is running out until an angry beep is heard. d-BASE III has an asterisk only at the end of the field; other database managers show the field underlined or in reverse video, so you know exactly how much room is left.

Editing of previously entered data is quite good, though no word processing capability is included. Once a file has been created, say of several hundred names, you can search, for example, for all names called "SMITH". Unfortunately, this is not the same as a name which has been typed "Smith". This is a decided weakness, and a search file is limited to only 300 records which is even weaker.

One of the first needs of database manipulation is to sort into alphabetical or other order. Suppose you have a file of all members of the local sailing club. This isn't much use unless in alphabetical order. Oddly enough, Beta-Base will sort a searched file but not the original file. This is such a weakness it would probably put me off buying, in spite of its many other strong points.

Another apparent bad point appears to lie in the way the file is created as a continuous sequential string of records not just tucked in randomly wherever there is room.

Suppose you have a file 1000 records long, and the disk develops a fault halfway through. The file cannot be read in and Beta-Base cannot then build up a directory of where all the records are. Not satisfied with a partial list, it bombs out. So unless a complete copy has been kept, the entire file is lost — which is tedious, exasperating, annoying, provoking, and other things as well.

However, all things are possible in the world of computers and a clever programmer might be able to recover most of data, though I confess I failed.

While Beta-Base seems an excellent aid to teaching the essential points of database management, I feel it is too frail for serious work.

## Longer life

The Micropolis Corporation has boasted the reliability of its Winchester 1300, 1320 and 1350 series disk drives to 20,000 power-on hours.

The equivalent of more than nine and a half years of normal eight-hour working days, this is a substantial increase on its previous MTBF (mean time between failure) standard of 13,000 hours.

## HARRIS Electronics

- We specialise in the conversion of overseas computer & video tape recorders to NZTV channels. (Any quantities from individual units to large production runs.)
- Stockists of Commodore computers, hardware & software.
- Monitors repaired and aligned.
- We stock PAL and NTSC Monitors, also quality new and used TV's.

**653 Manukau Rd, Epsom. P.O. Box 84-017, Logan Park.  
Phone (09) 658-416**

# Subroutines and random numbers

By Barbara Bridger

As the programs you write become longer and more complicated, you should make more and more use of subroutines. A subroutine can be used when the same sequence of instructions is required at more than one place in the program, thus reducing the length of the program. The use of subroutines also helps to produce a well structured program which will be easier to debug and modify.

The straightforward command in Spectravideo BASIC to branch to a particular subroutine is "GOSUB line number" but there is also the statement "ON expression GOSUB list of line numbers" which can be used to branch to one of several subroutines depending on the value of the expression. The subroutine must start on the given line number and the last statement of the subroutine must be a RETURN.

The expression can take any value between and including 0 and 255 but other values will result in an "illegal function call" error message. Non-integer values have the decimal part truncated — 1.9 is treated as 1.

If the value is 0 or something greater than the number of line numbers in the list, the program will proceed to the next executable program statement. The list of line numbers does not have to be in ascending order and any particular line number can appear more than once in the list. The maximum number of line numbers in the list appears to be limited by the length of list that can be fitted into one program line.

This example shows the use of the ON... GOSUB... statement to control sprite movement from joystick input.

```
10 SCREEN 1
20 U$=""
30 FOR I= 1 TO 8
40 READ A
50 U$=U$+CHR$(A)
60 NEXT I
70 SPRITE$(1)=U$
80 DATA 16,16,16,16,254,16,1
90 X=126:Y=95:C1=1:C2=1
100 DI=STICK(1)
110 ON DI GOSUB 140,180,160,
200,150,190,170,210
120 PUT SPRITE 1,(X,Y),1,1
130 GOTO 100
140 Y=Y-C1:RETURN
150 Y=Y+C1:RETURN
160 X=X+C2:RETURN
170 X=X-C2:RETURN
180 X=X+C2:Y=Y-C1:RETURN
190 X=X-C2:Y=Y+C1:RETURN
200 X=X+C2:Y=Y+C1:RETURN
210 X=X-C2:Y=Y-C1:RETURN
```

Here is a useful subroutine written by R.W. Curwood. If you want to get a printout of a screen picture which involves sprites, these need to be made part of the foreground. The subroutine will do this for a high resolution (16 x 16) sprite. It is necessary to assign values to C (colour wanted for sprite), S (sprite number), and X, Y (sprite location on screen 1, 2) before calling the subroutine.

```
1000 TE$=""
1010 FOR I=0 TO 15
1020 TE$=BIN$(VPEEK(14336+I+
S*32))
1030 IF LEN(TE$)<8 THEN TE$=
"0"+TE$:GOTO 1030
1040 FOR J=0 TO 7
1050 IF MID$(TE$,J+1,1)="1"
THEN PSET(X+J,Y+I+1),C
1060 NEXT J,I
1070 TE$=""
1080 FOR I=0 TO 15
1090 TE$=BIN$(VPEEK(14352+I+
S*32))
1100 IF LEN(TE$)<8 THEN TE$=
"0"+TE$:GOTO 1100
1110 FOR J=0 TO 7
1120 IF MID$(TE$,J+1,1)="1"
THEN PSET(X+J+8,Y+I+1),C
1130 NEXT J,I
1140 RETURN
```

When programming games or simulations, it is often necessary to generate a random number on a given interval or restricted to certain values — an integer value from 0 to 255 inclusive to determine the column position of a sprite or the integer values 1, 2, 3, 4, 5, or 6 to simulate the throw of a dice.

## Tetra Horror

By Barbara Bridger

This game has been around for a while but I have only recently had a chance to try it and found it rather intriguing. The aim is to manoeuvre Tamo, an adventurer, to collect as much treasure as possible.

To gain access to the treasure, Tamo must first collect fuel cans which are guarded by snakes, then negotiate the walls and stairs of a castle while shooting at skulls and avoiding boulders and snakes. One false step in the castle and he is over the edge and falling down into a bed of knives.

One feature which appealed to me was that having fallen over an edge, a reprieve was possible if Tamo could be guided onto a rising cloud and kept from making contact with any of the

The Spectravideo random number generator gives numbers ranging from .000000000001 to .999999999999. These can be converted to the required range simply by multiplying the random number by an appropriate factor and using the INT(x) function. INT(x) removes the decimal part of a number ie A=INT(y.xzq) means A takes the value y.

RND(x) where x<0 will seed a new sequence of random numbers but the same sequence is always generated for a particular x.

RND(x) where x=0 repeats the last number generated.

RND(x) where x>0 gives the next random number in the sequence.

RND(-TIME) provides an unpredictable start to a random number sequence because the value of TIME is always changing.

It is perhaps worthwhile pointing out here that the so called "random" numbers generated by computer are not truly random because each number in the sequence is not independent of the number before it.

There are various ways of assessing how good a particular random number generator is, including determining how many numbers are produced before the sequence starts repeating itself and how uniform the distribution of numbers is.

A limited investigation into these two characteristics found no fault with the Spectravideo random number generator. A quarter of a million random numbers were produced without repetition of the first six digits and no significant difference between observed and expected distribution of numbers was found using the chi-squared test.

SOUND and PLAY are two commands that will be looked at in future articles but we would be pleased to hear of other topics readers would like to see in this column. Please write to 11 Mawson St, Lower Hutt.

numerous skulls gliding past as he is carried back up to the castle.

There are three levels of difficulty — practice, normal and arcade. The higher levels have skulls as well as snakes guarding the fuel cans, more boulders and snakes to dodge and more skulls to shoot in the second phase — and the skulls can retaliate by spitting fire at Tamo in the arcade level.

The graphics and sound effects are very good and the skill required to move Tamo precisely plus the constant pressure of time (there is a time limit at each stage) make this an enjoyable and absorbing game.

This program is available on tape, costs \$18 and requires a SV328 or SV318 plus 16K added RAM to run it.

# The joys of Tasword Two

By Gary Parker

The Spectrum, one of the oldest of the popular home computers, cannot match some of the newer models in terms of hardware. So why is it still so popular? Obviously, low price is a factor in its continued success.

But its major strength lies in its support from independent manufacturers. Any hardware add-on you could possibly want is available. Any sort of program you could possibly have any use for can be obtained.

In some cases, software is available on the Spectrum which is not available on any other micro, and I have known Spectrums to be bought because of the availability of an obscure language alone. As every computer owner (but sadly, not every computer buyer) knows, a computer is only as good as its software.

This month, I take a look at a couple of programs I use on the Spectrum. One is the word processor, Tasword Two, and the other is the programming language, C.

While there may be dozens of versions of most programs available for the Spectrum, there are not many word processors. Why is this? Early in the Spectrum's history, an excellent word processing program called Tasword Two appeared. Since it did not have any major faults, few competing word processors have been produced, and Tasword Two has become a sort of standard.

I always took the features and ease-of-use of Tasword Two for granted until I began to use word processors on other computers. The Apple has several big-name word processors available for it, but they seem less easy to use than Tasword Two. Too many word processors require several key presses or changes of mode to do simple things.

The manufacturers don't seem to have paid enough attention to what commands writers use most, so that to add a letter requires as much effort as shifting a paragraph. A word processor has to be quick and easy to use, otherwise you find that you can't be bothered using all the available features.

## Advantages of a word processor

What advantages does a good word processor such as Tasword have over an ordinary typewriter? The most important difference is the ease with which changes can be made. If I had to use a typewriter to write an article, I would have to write it by hand first, then scribble alterations all over it, and finally type it out. With a word processor I can eliminate the first stage. I type the article straight out, make a few changes, and SAVE it. The next day, I LOAD it again, add a few new things I've since thought of, and print out the final version.

You write much more freely knowing that nothing you type is irrevocable marked on paper. This difference applies equally well to people who write only short letters and suchlike. What if you write a letter to a Mr Smith and then find out it's actually Mr Smythe? With Tasword, you would simply press R in extended mode, type Smith and Smythe, and all occurrences of Smith will be changed to Smythe.

Other advantages of good word processors, and Tasword in particular, are numerous. You can move whole paragraphs with a few key-presses. The text will have a much neater appearance because it is justified both right and left, instead of leaving a ragged edge down the right side. Especially important if you're not a perfect touch-typist and need to look at the keyboard sometimes while typing, words will not be cut off at the end of the line, but moved neatly to the start of the next line.

Because Tasword is almost a standard on the Spectrum, you can send a text file on tape to other Spectrum users, and they can LOAD it and make alterations before printing it out.

## Closest to the ideal

I'm not saying Tasword is perfect, but it certainly is closer than most to the ideal word processor for a home

## The power of C

Manufacturers and software writers always seem to be trying to make the Spectrum do a little more than you would expect of it. Take the programming language, C. At first, it was available only on large computers, then it moved into mini computers. Recently, some of the more powerful business micros have been running C. But C on a home computer? Never!

Yet it is available on the Spectrum. Hisoft C is a powerful implementation of one of the newest languages. C is a fast-running, flexible language designed mainly to run on 16 and 32-bit computers with the UNIX operating system. Because of its speed and ability to act as a low-level language, C is popular with commercial business software writers, and many well-known business programs are written in C.

C is not too different from PASCAL, although it bears little resemblance to BASIC. It is a powerful language because it allows the user to "get close to the hardware" — you can do things with C that could cause the computer to crash. In this respect, C is a mixture of a sophisticated high-level language such as PASCAL, and a low-level language such as a machine code assembler. By ignoring some of C's features, you can

computer. And its price is a tenth of some others.

How does the Spectrum hardware fare as a word processor? Most obviously, the rubber keyboard is not really suitable for anything but the shortest of letters. The Spectrum Plus keyboard is a big improvement, and should be adequate for the home user. For the professional, another keyboard can be added. There are many available. I have tried the Fuller, Stonechip and Lo-Profile keyboards. They all perform well and make the Spectrum look like a business computer. My favourite is the Lo-Profile unit, since it has a particularly pleasant key action.

Of course, to be useful, a word processor requires a printer. On the Spectrum, a printer interface must be connected. Sinclair's Interface One provides an RS-232 interface for connection to RS-232 printers. For a Centronics printer, a converter interface must be connected to Interface One, or a separate Centronics interface used. Many different models are available.

I use a Kempston interface. Before use, a very short program must be loaded. Other interfaces have the program in their own ROM, so you don't need to load anything. An example is the Euroelectronics model which offers both RS-232 and Centronics interfaces in the one box.

use it just like a high-level language. But programs won't be faster than other compiled languages.

More adventurous programmers can make use of C's "low-level" features (such as pointers), when the power of C really becomes apparent. I won't try to explain these features here, because C is so unlike BASIC that it really takes a book to demonstrate them, but here is a C listing to show what it looks like:

```
/* compare two strings */
char *s, *t;
[
for ( ; *s== *t; s++, t++ )
    if ( *s == '/' )
        return ( 0 );
return ( *s - *t );
]
```

C is an advanced language, and I wouldn't recommend it to Spectrum users still struggling with BASIC. But for more advanced users who know a little about machine code and the low-level operations of their Spectrum, C can be a great language. I think I like the structure

and flexibility of C better than PASCAL, but it is too easy to make C programs crash!

Hisoft C is a surprisingly complete version of the language. At the moment, floating point numbers are lacking, but they are said to be on the way. The program is very professional, with an excellent editor and its own program listing method and cassette routine and so on.

As I've said before about Hisoft PASCAL, if you connected a full-size keyboard and hid the Spectrum, it wouldn't be too difficult to convince people they were using a large business computer!

## New plotter range

CALCOMP has introduced an AO size low-cost digital pen plotter. The series includes high speed cut sheet plotters as well as dual-mode (extended plot capability) models that run batch jobs as well as single plots.

All three models feature built-in controller, intelligent 40-character alphanumeric control panel, eight-pen turret and ROM pack firmware. An HPGL emulator is available.

The plotters are distributed in New Zealand by Datamatic Computer Systems, Ltd (P.O. Box 27-056, Wellington).

# QL update

By Gary Parker

A lot has happened on the Sinclair QL scene since last month's review. Independent manufacturers have released myriads of new products, guided by standards set by Sinclair, and Sinclair itself has produced several new software packages and upgraded old ones.

PSION has doubled microdrive loading speeds on the Version 2 releases of the software which comes with the QL — Quill, Abacus, Archive and Easel. The overlaying techniques which slowed program execution have been completely eliminated, and program size has been reduced so that more memory is available for data. The programs can now be used with disk drives using the standard set by Sinclair, and many new commands have been added to the database, Archive.

PSION has released the four programs for the IBM PC, IBM XT, ACT Apricot, Sirius, and soon Macintosh, for PDS 495 — more than the price of a QL and software together.

New business software released by Sinclair includes QL Cash Trader, WL Integrated Accounts, QL Project Planner, QL Decision Maker and QL Entrepreneur. Soon to be released are QL Payroll and QL Stock Control/Invoicing. Other programs promised by June 1985 include QL LOGO, QL Debugger, QL C and a "mega-game", QL Bandersnatch. Perhaps the most important new release is QL Toolkit which contains all the SuperBASIC features Sinclair didn't have time to include in the ROM — random access files, multi-tasking from SuperBASIC, a full-screen editor, user-definable graphics, and much more, 56 commands in all.

Important news for people who prefer disk drives to microdrives is that three independent manufacturers already have disk drive interfaces on offer. Sinclair has set a standard for QL disks, so disks will be interchangeable between different manufacturer's drives.

Single and twin drive interfaces, using standard 5.25in floppy disk drives or the new 3.5in disk drives are available, ranging in price (including the drives) from about two-thirds of the price of a QL to one and a half times the QL price. Several hard (Winchester) disk units are available for about two and a half times the price of a QL. A QL laser disk has been exhibited which stores 2 Gigabytes of data, and costs £10,000.

Memory extension packs are available in 64K, 128K, 256K and 512K sizes. One manufacturer is offering a card with a Z-80a processor and 64K of RAM, containing the CP/M operating system. This will allow access to a huge range of proven software such as Wordstar and dBASE II. The card also contains two ports configured to act as a mouse controller and a parallel printer interface.

It sells for about half the price of a QL.

QL support is growing even faster than expected. Sinclair is taking the unusual but obviously very successful step of setting standards for QL products, and then helping independent manufacturers produce them. This has overcome most of the weaknesses of the QL mentioned in last month's review, and should ensure the success of what is now a truly remarkable computer.

## Business drive

Systems Programming (New Zealand) Ltd, a wholly owned subsidiary of SPL (Australia), has been established here to step up sales of the Software AG product range.

This software includes some very sophisticated application development systems, along with high level business software which has found success with such Australian organisations as the Australian Bureau of Statistics, Reserve Bank of Australia, Australian National Industries, Nissan and Dulux.

## SENSATIONAL SOFTWARE

As advertised in overseas magazines the best in BRITISH is now available in N.Z.

### LATEST RELEASES

|                     |                         |         |
|---------------------|-------------------------|---------|
| <b>BUG-BYTE</b>     |                         |         |
| TWIN KINGDOM VALLEY | 48K, BBC, C64, ELECTRON | \$34.95 |
| TURMOIL             | 48K                     | \$24.95 |
| STAR TRADER         | 48K, COMMODORE 64       | \$24.95 |
| KUNG FU             | 48K                     | \$24.95 |
| RAPSCALLION         | 48K                     | \$24.95 |
| <b>VORTEX</b>       |                         |         |
| CYCLONE             | 48K                     | \$24.95 |
| T.L.L.              | 48K                     | \$24.95 |
| ANDROID TWO         | 48K                     | \$24.95 |
| <b>AUTOMATA</b>     |                         |         |
| DEUS EX MACHINA     | 48K                     | \$49.95 |
| TEN PACK            | 48K                     | \$49.95 |
| <b>MIKRO-GEN</b>    |                         |         |
| PYJAMARAMA          | 48K, AMSTRAD, C64       | \$24.95 |
| WITCHES CAULDRON    | 48K, COMMODORE 64       | \$24.95 |
| AIR TRAFFIC CONTROL | 48K                     | \$39.95 |
| EVERYONE'S A WALLY  | 48K, C64, AMSTRAD       | \$29.95 |
| <b>MICROSPHERE</b>  |                         |         |
| SKOOLDAZE           | 48K                     | \$24.95 |
| SKY RANGER          | 48K                     | \$24.95 |

### BUDGET SOFTWARE

All \$9.95 While stocks last

|                          |     |                  |     |
|--------------------------|-----|------------------|-----|
| 3D Dimension Destructors | 48K | Spectipede       | 16K |
| 3D Combat Zone           | 48K | Golf             | 16K |
| Star Trek                | 48K | General Election | 48K |
| Cavern Fighter           | 48K | Cropper X1       | 16K |
| Looney Zoo               | 48K | Castle           | 48K |
| Pool                     | 16K | Aquarius         | 48K |
| Galaxians                | 16K | Earth Defence    | 16K |
| Pin-ere                  | 48K | Pinomania        | 48K |

### BUSINESS SOFTWARE

|                             |       |
|-----------------------------|-------|
| TASMAN CENTRONICS INTERFACE | \$160 |
|-----------------------------|-------|

Selected titles at leading retailers or order by enclosing cheque/postal order to:

Software Supplies P.O. Box 865 Christchurch

Over 100 titles available for the Spectrum, Commodore 64, Atari, BBC, Electron and Amstrad Computers.

Full catalogue available by sending S.A.E. to above address.

Trade Enquiries Welcome.

### ATTENTION WRITERS/PUBLISHERS

We offer 1st class duplicating facilities and marketing services.

All computers catered for Quality Guarantee. P.O. Box 865, Christchurch.



## SANDFLY SOFTWARE

putting the byte back into computing!!

The acclaimed Personal Banking System from Britain (over 10000 copies sold) is now available in New Zealand. Some of the many features of the SPECTRUM PBS are:-

- \* Maintains permanent bank records.
- \* Automatic generation of standing orders on due dates.
- \* Automatic Bank Reconciliation Full reporting with display and printout.
- \* Full search facilities
- \* Automatic double entry book-keeping.
- \* Back Value/Forward Projection.
- \* MICRODRIVE compatible.
- \* 80 COLUMN and other printers supported.
- \* Many more features.
- \* Demonstration program and detailed manual supplied.
- \* Send S.A.E. for full details

The PBS is available for:-

ZX81 (16K) ..... \$19.95

SPECTRUM (48K) ..... \$29.95

BBC Model 'B' ..... \$29.95

Available from good computer shops or send cheque or postal note to:-

**SANDFLY SOFTWARE**  
P.O. BOX 45  
TE ANAU.

Trade enquiries welcome.



"I write all my letters and reports with our Spectrum+."

"mmmmm . . . and I look after the club accounts . . ."

"I'm learning to program . . ."

"I want to play Zipper Flipper . . ."

**NEW!**

# SINCLAIR ZX SPECTRUM+ has got something for everyone!

## NEW Sinclair ZX SPECTRUM+

Make the fabulous new addition to the Spectrum family a member of your family! There's something for everyone — and that's what has made the Spectrum the world's most popular home computer!!

Why? Well, to start with its great fun to use . . . Colour! Sound! Superb graphics. There are literally hundreds of excellent programs available,

from fast-action games, educational programs to business and professional programs.

And to top it all — you can learn to write your own programs, design games, develop application software. Its all made so easy because the Spectrum+ comes complete with a companion cassette and user guide tutorial.

A powerful 48K of memory and the new professional style keyboard (ergonomically

designed for fast keying) keep the Sinclair Spectrum+ top of its class!

Peripherals? You want peripherals — well, we've got them . . . interfaces to add joysticks and plug in ROMS, ZX Microdrives, printers, RS232 . . . everything you will ever need to make the most of your Spectrum+.

Sinclair Spectrum+ — see it and try it out at your nearest Sinclair computer stockist TODAY!!!

**SUPER LOW PRICE!**

**\$599**

Supplied complete with Sinclair User Guide, Companion Cassette, and leads.

**SPECIAL OFFER!**

Super savings on the world's most popular home computer!  
**16K ZX SPECTRUM  
6 CASSETTE PACK**

**LOOK WHAT YOU GET . . .**

- Fabulous 16K ZX Spectrum (easily upgraded to 48K)
- Six Super program cassettes in special display box
- Games include these hot favourites . . . Hungry Horace, Space Raiders, Planetoids, Reversi.



**GET THE LOT FOR ONLY \$399**



**DAVID REID ELECTRONICS**

AVAILABLE FROM

**OVER 800 DEALERS**

NATIONWIDE!

- AUCKLAND CITY 70 Anzac Ave., Auckland 1. Ph: 32-499
- TAKAPUNA 3-5 Auburn St, 9. Ph: 497-064/6
- ONEHUNGA 300 The Mall. Ph: 641 013
- PAPATOETOE 178 Kolmar Rd., Hunters Cnr. Ph: 278-2037
- HAMILTON 131-135 Ward St. Ph: 81-484
- NEW PLYMOUTH 250 Devon Street East. Ph: 83-309
- NAPIER Dickens St. (Thackeray St.) Ph: 55137 53589
- PALMERSTON NORTH 212 Rangitikei St. Ph: 88-109
- LOWER HUTT 109 Queens Drive, Ph: 693-309
- WELLINGTON 86 Vivian St. Ph: 848-198
- NELSON 135 Hardy St. Ph: 89-161
- CHRISTCHURCH 79 Lichfield St. Ph: 62-703
- DUNEDIN 317 Cumberland St. Ph: 774-496/6

# A tale of DOS

By Gordon Findlay

Last month, we looked at why a disk operating system is necessary — to save time, trouble and unnecessary work. The "mother" DOS of course is TRSDOS, written for Tandy by Randy Cook (I kid you not — that's his name). Cook has a reputation for brilliance, and for being easily bored; and Tandy has a reputation for working down to a price — or at least it used to. And TRSDOS was, in intention at least, in advance of any of the micro operating systems available at the time. For these and other reasons, TRSDOS was unreliable, with bugs by the dozen, and it soon spawned a minor industry in patches and enhancements.

TRSDOS has gone through several versions. The main current ones are version 2.3 for the model 1, and 1.3 for the model 3. Several versions had a very limited life — version 2.3B, which was supplied with a disk assembler package and was incompatible with every other version, and version 2.7DD, intended to support double density drives on the model 1, were universally condemned.

TRSDOS was soon enhanced, Randy

Cook himself working on an independent version called VTOS. A group of enterprising enthusiasts reworked parts of TRSDOS, producing NEWDOS which has gone through a number of versions, the earlier ones based on TRSDOS, and the later NEWDOS80 versions written completely from scratch. The most successful version of NEWDOS has been NEWDOS80 version 2.

The group of enthusiasts formed a company, Apparat, which marketed several products as well as NEWDOS. It's perhaps worth noting that Apparat tried very hard to support NEWDOS, as it should, but the pirates virtually killed their business.

Why was NEWDOS so much more popular than TRSDOS? There were several additions worthy of note, all of which have been incorporated in some way into the later DOSes. The most important is the ability to support a variety of hardware, such as disk drives.

The implementation under NEWDOS80 involves a PDRIVE command, with numerous options and a less-than-elementary description in the manual. This rather confusing discussion has been frequently lambasted, as have other parts of the manual, but once mastered, the PDRIVE command is very flexible, allowing the user to change the hardware specification "on the fly" as it were — a real boon when copying disks for other people with different configurations.

Another advance made in NEWDOS was a great extension of the COPY command. Under early versions of TRSDOS, single drive users had some difficulty in copying files (as opposed to complete disks).

NEWDOS adds a variety of options for selecting the files to be copied, and allows a copy without a system disk being mounted if necessary. Again, the documentation here is complete but confusing, especially since the various options can be summarised much more clearly.

A major feature of Apparat's handling of its DOS was the very full support. Patches were issued (to registered owners) to correct known bugs. The manual, often criticised for the level of difficulty and plain obscurity, is much more complete than that for TRSDOS — I've a copy of the original TRSDOS/DOS basic manual (early 1978) which is just 48 pages long.

NEWDOS documented a lot of internal routines which programmers found useful, and made access to the operating system from within a program very simple. Various utilities, the most famous being the first "superzap", enhanced the package.

Apparat also made enhancements to Disk BASIC. Various additional commands and extensions to existing commands were developed. Some were obscure — changing the string space dramatically; others were most welcome — abbreviated editing commands, for example.

The notorious additional types of data files were also an advance, but the documents were written in such a formal and obscure manner few understood them. These enhanced file types are totally incompatible with all the other DOSes, so commercial programs could not afford to use them for fear of restricting their own market.

NEWDOS remains popular, justly in my view, as a flexible DOS with a lot of useful and usable features. A longer tutorial section in the manual would have been useful, as would a rewrite of the whole manual by a technical writer. Later DOSes have added such features as redirection of input and output. Eventually, even Tandy has gone away from the TRSDOS standard for the Model 4, offering both CP/M and TRSDOS 6, which is a version of an independent Model 1 and 3 DOS, LDOS.

There is no room for a detailed comparison of all the DOS commands and features. I will be offering later a set of charts comparing them all.



Everybody's talking about it. Find out for yourself — write to Freepost 133, Box 6186, Dunedin, for details on our latest software for the Apple II family.

**otakou software**

**COMPUTER WORKS** Supply and support of computer systems for Business, Trades and Professionals.

**SANYO** and other top computers, printers and software.

*Microcomputers that mean business*

**COMPUTER WORKS**

First floor, Queens Arcade Phone 664 944  
Queens Drive, Lower Hutt Box 30-669

## New Tandy machines

A number of new Tandy machines are now here. The Model 2000 is an MS-DOS machine, but not an IBM clone — it's much better, according to Tandy! Two compatibles are available — the 1200, with a hard disk, and the 1000. Both seem, on short acquaintance, very good implementations of the IBM-like design. Both come with powerful bundled software.

The Model 100 lap computer has a larger brother, the Model 200 (original names!). The Model 100 software is improved, and full MSDOS is added, with a built-in version of Multiplan and a calculator package.

The screen is a flip-up LCD type, with 16 lines of 40 characters, and 240 by 128 graphics. RAM is 24K, expandable to 72K. The disk drive and full-size video expansion box which can be added to the 100 will no doubt soon be adapted to the new model.

Also just released is the model 6000. Based around a 68000 processor with up to a megabyte of RAM, the model 6000 can support up to six, and eventually nine, users running the Xenix operating system (a UNIX derivative). There is also a rumour, unconfirmed as I write this, of a colour portable from Tandy, so start saving your pennies.

# Atari- why the shortage

By Michael Fletcher

Numerous new products have recently been released for the Atari overseas. These products are many and glorious but unfortunately most are not available in New Zealand.

Perhaps one of the more noteworthy new products is the Okimate 10 personal colour printer. Unlike the Atari colour printer, the Okimate has 80 columns of print, 26 different colours, and writes in letter quality print. It is understood it will be available in New Zealand for the Atari at under \$900. The printer is being brought into the country by an Auckland-based retail shop and should be here before the end of July.

On the software scene, there are thousands of exciting programs released in USA but not available in New Zealand. Here are some of the most appealing.

- Gryruss (Parker Brothers): A direct copy of the arcade version where you control a space ship which must destroy the hordes of aliens attacking our solar system, it features an excellent sound track.

- Manocopter (Datasoft): Pedal your helicopter past sharks, biting birds, lightning storms and many more nasties in this arcade game.

- Pitstop II (Epyx): Winning is not always in the driving in this graphic

wonder.

- Breakdance (Epyx): Pop and bop until you drop in this new breakdance simulation.

- Pitfall II (Activision): The sequel to the famous VCS game, Pitfall. In this game, you take over the features of Pitfall Harry as you explore vast underground caverns. Unlike the other games, this should be available in New Zealand soon.

- Dataprefect (LJK Enterprises): This powerful business database comes from the same company that makes the letter prefect word processor — so it's no surprise they are compatible with each other. Dataprefect has excellent report writing and global exchange capabilities.

This is only a small selection of products available overseas but not available in New Zealand. Along with many other Atari owners, I would like to know why, there is a shortage of independently made software and hardware for Atari users in New Zealand. Monaco Distributors has been instrumental in trying to rectifying this problem but the solution is still a long way away. Surely, there must be one importer willing to bring new software and hardware into the country.

## A thriller on ice

The game, Pengo, was seen for the first time in New Zealand on the Atari when Monaco Distributors exhibited it on an Atari 600XL at last year's Auckland microcomputer show. At last, it is available at most Atari computer dealers — and it is well worth the wait.

The gameplay is diverse but true to the original arcade version. Pengo is an extremely cute and lovable penguin until recently living out his life very happily in the extreme frozen waste of the South Pole, until he is invaded by the penguin's worst enemy — the dreaded, dastardly and devious Snowbee.

As in the arcade version, the screen for Pengo is a huge icefield. The main weapon you (as Pengo) have is the ice itself; in this case, you have to use square blocks of ice to repulse the invading Snowbees. To attack a Snowbee, Pengo has to position himself in front of an ice cube and then push the block of ice (achieved by pressing the action button) onto any oncoming Snowbees. For this task, you can amass a total of 200 to 1600 points (sound familiar Pacman fans?), the score doubling for each consecutive Snowbee you destroy.

However, this destruction system has its drawbacks — you can push the ice blocks in only four directions (up, down, right and left) and you have to be facing the direction you want to push the ice block. So once you've committed yourself, you have only one chance out of four to kill an oncoming Snowbee.

If you plan far enough ahead, this margin can very easily be cut down. Once you push an ice block at an advancing Snowbee, the Snowbee is trapped and crushed against the side of the ice wall.

There are other methods of amassing points with more intricate defence tactics.

Pengo's sound and graphics are terrific, especially the music which plays throughout. A lot of care and preparation has gone into the animation of Pengo and the Snowbees. Another plus is the array of colours which, especially the contrasts used on Pengo, make all the moving parts seem like a TV cartoon.

I have seen only one other version of Pengo — the Spectrum's Pengi musically and graphically, if you want to play a home computer version of Pengo, don't buy a Spectrum.

Pengo is a 16K cartridge and is available at most Atari dealers.

## Underlining

If there are any 1027 printer owners having trouble with underlining a printed copy in conjunction with the Atariwriter word processor, here is how you do it:

Control O then the number 15; type what you want underlined, then Control O followed by the number 14; after this, press return.

This instruction is not in the Atariwriter manual and I have found it an enhancement to word processing on the Atari.



**COMPUTERS FOR PEOPLE**

**BUSINESS SYSTEM SPECIALISTS**

35 Taranaki St, Wellington  
Phone 847-668, 847-628

69a Rutherford St, Lower Hutt  
Phone 664-069

Pass Bits & Bytes to a friend

### MICROPAC MAILWARE

#### FLEXIBLE DISKS and TAPES

Many years of guaranteed reliable data storage with our top brands of diskettes.

**VERBATIM DATALIFE** 5 1/4" in library case, hub rings.  
Single sided, single/double density  
10 disks **\$62.60**

Double sided, single/double density  
10 disks **\$82.00**

**MAXELL** 5 1/4" in library case, hub rings, guaranteed for 10 years!  
Single sided, single/double density  
10 disks **\$62.60**

Double sided, single/double density  
10 disks **\$82.00**

#### SPECIAL OPENING OFFER

3 boxes of 10 disks 10% discount.

#### VERBATIM DATA CASSETTES

100m each **\$13.45** box of 10 **\$129.90**  
A must for reliable data storage:  
**HEAD CLEANER KIT** for 5 1/4" drives **\$18.16**  
**DISK MINDER**. Looks good on your desk.  
Holds and protects 50 5 1/4" diskettes. Makes an excellent gift too. **\$42.95**

#### PAPER and LABELS

11x10" plain or gold bar  
3000 sheets **\$70.56**  
1500 sheets **\$39.96**

11x10" plain, perforated for WP 2000sh. **\$63.60**  
Address Labels, self-adhesive 90x23mm on pin feed base, box of 1000 labels **\$13.26**

#### ORDERING INFORMATION

Add \$2 p&p for each order. All merchandise is brand new and guaranteed. In-stock items will be shipped within 24 hours. Send your name, address, phone number, type of computer/printer and your money order, postal order, cheque or credit card specification to:

MICROPAC MAILWARE  
FREEPOST 88 (no stamp required)  
P.O. Box 935, Hastings.

Holders of a valid credit card (not Visa) can order by telephone (collect) Auckland (09) 775-442 anytime. Orders and inquiries (070) 66-451 (business hours).

Please debit my credit card  
 Bankcard     Amex     Mastercard

Card Number (sorry no Visa) 

Name \_\_\_\_\_

Expiry Date \_\_\_\_\_

Signature \_\_\_\_\_

**HAPPY COMPUTING!**

iicropac mailware

# Assumes a lot

*The RS-232 Solution* by Joe Campbell. Sybex, 1984. pp94. \$36.95. Reviewed by Gordon Findlay.

One of the greatest misnomers in history would have to be the RS-232 "standard". Devices which use this so-called "standard" for connecting peripherals to computers use come different arrangement. This book sets out to show you how to connect what is called a "foolproof method which requires no expensive tools and only minimal knowledge of electronics. You won't even need the manufacturer's documentation!" Well, that's what it says.

The first part of the book describes the theory, some of the practice, and many of the tricks of the trade for finding out what is happening between two pieces of equipment. This is followed in part 2 with several case studies, and a discussion (very cursory and useless) of some professional tools.

This is a tall order, and the book could not possibly deliver on its promise. For a starter, it deals almost exclusively with the wiring of the cables between two devices. Such is the state of the industry there is lots of room for confusion in so

simple a matter as deciding which pins to wire to which. But implicitly, the book assumes the form of the transmitted data is known — things like baud rate, parity and stop bits — and that the "receiver" is set up appropriately.

How you obtain this information without the manufacturer's documentation is difficult to say! I have been in the situation of having all the documentation, all the tools in the world, and a very clever engineer to help interpret the things we were seeing, and having difficulty getting two simple devices to talk to each other! It's no wonder the book falls short of its goal.

Interesting to those with a hardware bent, and patience. Just don't think the book will solve all the problems once and for all — we'll still need the experts.

## Building on the Z80

*Z80 Applications* by James W. Coffron. Sybex. 290pp. \$32.95. Reviewed by I. Hemmingsen.

Anyone wanting to build a microprocessor controlled system or

add interfaces to a Z80 based system should read this book.

For the enthusiast, the biggest obstacle is obtaining the data sheets of the support devices and understanding the technical information given.

This book provides both the technical information and a detailed description on the operation of each device, including typical machine code programs and circuit diagrams.

The first four chapters cover information on the common memory devices and typical circuits. These chapters would be useful to those building a system from scratch or adding memory to their system.

Another chapter discusses the three interrupt modes of the Z80. Example applications for each mode are given.

Another six chapters are devoted to interface devices designed to work with the Z80 processor. These are the 8255 PIA (programmable interface adapter), 8253 (programmable timer), 3881/Z80-PIO (programmable input/output), Z80-CTC (counter timer chip), 8251 USART

# Melbourne House BOOKS AND SOFTWARE COMPETITION

EVERY ENTRY WINS A PRIZE!

- Go to your nearest computer store or bookshop and examine the exciting range of **Melbourne House** books and software on display. Purchase your selection.
- Detach special Competition Pack label and affix to entry form in panel below.
- Fill in details on entry form and post. No stamp required.
- Allow 21 days to receive your prize. Every entry wins a copy of the booklet *Taking Care of Your Computer*. Every 25th entry wins a book or software for use with their own machine.
- *Incomplete entries will be disqualified.*
- **COMPETITION CLOSES: 31 MAY**

## ENTRY FORM

NAME \_\_\_\_\_

ADDRESS \_\_\_\_\_  
\_\_\_\_\_

Name of dealer/shop where you purchased **Melbourne House** product for entry  
\_\_\_\_\_

Your brand of computer  
\_\_\_\_\_

PLEASE COMPLETE FOLLOWING DETAILS:

Have you purchased **Melbourne House** products before? **YES/NO**

Reason for selecting **Melbourne House** product  
\_\_\_\_\_

AFFIX  
COMPETITION PACK  
LABEL HERE

CLIP AND POST TO: Roulston Greene  
**Melbourne House Competition**  
Freepost 1231  
Private Bag  
Takapuna  
AUCKLAND 9

(universal synchronous asynchronous receiver transmitter) and the Z80-SIO (serial input/output).

The final chapter covers a hardware debugging and trouble shooting technique called static stimulus testing (STT). Using this, you can check out your hardware interfacing without using software. This is particularly useful when the "bug" stops the processor executing any software.

Because of the technical nature of this book, the author assumes a basic knowledge of digital electronics and Z80 machine code programming.

If you have written some Z80 code and designed or built simple digital circuits, you should have little difficulty using this book.

With the information contained, you should be able to pursue any idea or application for a Z80 microprocessor system.

My only criticism is that a further appendix containing full manufacturers' data sheets on each device should have been included.

However, despite this criticism, this book is recommended to anyone building a microprocessor controlled system, or adding interfaces to their computer.

## Good for starters

*"Making the Most of Your TRS-80 Color Computer: by Peter Vernon. Prentice-Hall, 192pp, \$23.50. Reviewed by Martin Downey.*

Aimed at the first time computer user who has just bought, or is thinking of buying, a TRS-80 colour computer this book assumes the reader does not know the difference between the CPU and the VDU.

The first chapter explains the pieces which make up a computer in very simple language (e.g. 'A joystick has a lever that moves from side to side and backwards and forwards, producing numbers so the computer can detect where we move the lever.'). Program paks are covered in the next chapter, including outlines of 11 popular Tandy titles.

The next six chapters give a beginners course in colour BASIC, along with descriptions of all the commands and functions in the standard and extended BASICs. Some of the information is repeated

from the manual but this text goes a bit further and provides a number of example programs.

The book concludes with information on extending your colour computer with alternative languages and disks. Some useful appendices are also provided. A worthwhile book for the new computer user.

## UNIVERSITY BOOK SHOP

Specialists in  
COMPUTER BOOKS

Over 1000 titles  
in stock

PHONE OR WRITE: VISA BANKCARD

STUDENT UNION BUILDING  
34 PRINCES ST AND 34 KITCHENER ST  
AUCKLAND 1  
TELEPHONE 771 869

# NEW FROM PITMAN

## EXPLORING MUSIC WITH THE BBC MICRO AND ELECTRON \$38.95

How to generate sounds and rhythms to produce exciting and distinctive musical styles and instrumental effects.

## THE SINCLAIR QL COMPANION \$19.95

The essential handbook for QL users.

## COMMODORE 64 GRAPHICS COMPENDIUM \$19.95

and SPECTRUM GRAPHICS COMPENDIUM \$19.95

Useful graphic designs and programs and a large library of pre-defined graphics characters.

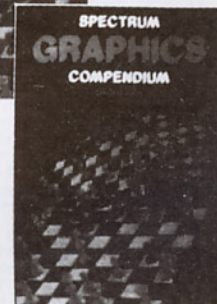

**FURTHER INFORMATION: PITMAN PUBLISHING NEW ZEALAND  
PO BOX 38 688  
PETONE**

# USER GROUPS

- BBC MICROCOMPUTER USERS' GROUP OF NZ, Local meetings - Auckland: 2nd Wednesday of month at VHF Clubrooms, Hazel Ave, Mt Roskill. Ph. Dave Fielder, 770-630, ext 518 (h). Wellington - meets last Thursday of each month in staffroom, first floor, Correspondence Centre, Portland Cres, Thorndon. Local contact, Anton, 286-289. Hamilton - Waikato Tech B-block staffroom; last Wednesday of the month 5 p.m. Local contacts Peter (Ham) 393-990 or Alison (Morrinsville) 6695. Hawke's Bay - Hastings and Napier alternate months. Local contacts: Kendall (Napier) 435-624, Bob (Taradale) 446-955; Mitch (Hastings) 778-235. Christchurch - fortnightly, Tuesdays, 7 pm, Hagley High School. Local contact Michael, 582-267.
- SANYO USER GROUPS have been set up in Auckland, Wellington and Christchurch. Contact P.O. Box 6810, Auckland for further information.
- SHARP PC1500 USER GROUP - Contact: Allan Thomas, P.O. Box 155, Napier. Newsletter.
- BAY OF ISLANDS COMMODORE 64 USER GROUP: Contacts - Mrs B. McLeish, P.O. Box 119, Okaihau (secretary), or Mr H. Perry, 143 Church Street, Onerahi.
- KERIKERI COMMODORE 64 USER GROUP: Contact: Brett Snow, Skudders Beach, Kerikeri. Ph 78-888.
- WHANGAREI COMPUTER GROUP: 15 James Street, Whangarei. Phone 84-416. Meets every second Wednesday of the month at Northland Community College.
- N.Z. MICROCOMPUTER CLUB INC, PO Box 6210, Auckland. A meeting is held on the first Wednesday of each month at the OSNZ Hall, 107 Hillsborough Rd, Mt Roskill, from 7.30 pm. Visitors are also welcome at 10am - 5pm, at the same hall on the Saturday following the above meeting.
- The following user groups are part of the N.Z. Micro Club. Meetings start at 7.30pm at the OSNZ Hall.
- APPLE USER GROUP: Ross Bryon, ph 761-670 (h). Meetings: 3rd Tuesday.
- BUSINESS USER GROUP: Sam Chan, phone 678-518 (h). Meetings: 3rd Thursday.
- CP/M USER GROUP: Peter Morrin, ph 592-452 (h). Meeting: 4th Monday.
- IBM PC USER GROUP: Terry Bowden, ph 452-639 (h). 778-910 (w). Meetings: 3rd Thursday.
- GENEALOGICAL USERS GROUP: Maartin de Vries, ph 2674-886 (h). Meetings, 1st Wednesday, 9.15 pm.
- KAYPRO USERS GROUP: Russell Clement, ph 817-8525. Meetings, 4th Monday.
- POCKET COMPUTER USER GROUP: Peter Taylor, 14 Gollan Rd, Mt Wellington 6, phone 576-618 (h).
- SINCLAIR USERS GROUP: Doug Farmer, phone 567-589 (h). Meetings: 4th Wednesday.
- SORCERER USER GROUP (NZ): Selwyn Arrow, ph 491-012 (h). Meets at Micro Workshop.
- SORD USER GROUP: Graeme Hall, 5 Brouder Pl, Manurewa, ph 266-8133 (h).
- TI 99/4A USER GROUP: Ray Tucker, ph 568-155 (h).
- TOMORROW USERS GROUP: Chris Cotton, phone 789-153. Meetings: 3rd Thursday, 7.30pm, 20 Kingsley Street, Grey Lynn.
- WIZZARD USER GROUP: Richard McFadgen, 11 Hilling St, Titirangi, ph 8178-219 (h).
- 1802 USER GROUP: Brian Conquer, ph 695-669 (h).
- 2650 USER GROUP: Trevor Sheffield, phone 676-591 (h).
- 68XX (X) USER GROUP: John Kucernak, ph 606-935 (h).
- The above contacts can usually be found at N.Z. Microcomputer Club meetings and micro workshops, or via P.O. Box 6210, Auckland.
- Other Auckland-based groups:
- ACES (Auckland Computer Education Society): C/- Director, Computer Centre, Secondary Teachers' College, Private Bag, Symonds Street, Auckland. Meetings, third Thursday of month, at the College.
- ATARI MICROCOMPUTER USER GROUP: Ian Mason, 25 Manutara Ave, Forrest Hill, ph 467-347 (h). Meets 2nd Tuesday, Western Suburbs Radio Club, Gt North Rd, New Lynn.
- THE AUCKLAND VZ-200 USERS GROUP: President, Julian Bish, 22 Usher Place, Pakuranga. Phone, Auckland 562-166.
- BBC USER GROUP: Dave Fielder, ph 770-630, Ext 518 (w). Meetings: 2nd Wednesday.
- COLOUR GENIE USER GROUP, (Auckland): Secretary: Mrs Nola Huggins, Ph 655-7518, P.O. Box 27-387, Auckland 4. Meets every fourth Monday, All Saints Church Hall, Ponsonby Rd, Auckland.
- EPSON HX20 USERS' GROUP. Contact: C.W. Nighy, 231 Khyber Pass Road, Auckland, (Anspahone, 774-268).
- HP41C USERS' GROUP (Auckland): C/- Calculator Centre, P.O. Box 6044, Auckland; Grant Buchanan, 790-328 (w). Meets third Wednesday, 7pm, at Centre Computers, Great South Rd., Epsom.
- LXIV N.Z.: Aligned towards those using Commodore 64's, mainly in education. Contact Brother Bosco Camden, 52 Onslow Avenue, Epsom, Auckland.
- MSX/SPECTRAVIDEO COMPUTER CLUB: Contact: P.O. Box 22-620, Otahuhu, Auckland, 6. Meetings, 3rd Wednesday of month at IHC Hall, 56 Ranfurly Road, Epsom. Contact Bill Ferguson (Secretary). Ph. 276-1966, ext 803 (w).
- NZ COMMODORE USER GROUP (AK) INC: John Walker, ph 8339-589 (h). PO Box 5223, Auckland. Meetings: 3rd Wednesday, Remuera Primary School Hall, Dromorne Rd, Remuera.
- NZ OSBORNE USERS GROUP (NZOG): c/- P.O. Box 43-182 Auckland. Meetings: 1st Thursday. Auckland University, Human Sciences Building, Auckland. 7.30 pm.
- NZ TRS-80 MICROCOMPUTER CLUB: Olaf Skarsholt, 203A Godley Rd., Titirangi. Phone 817-8698 (h). Meets first Tuesday OSNZ Hall, 107 Hillsborough Rd, Mt Roskill.
- OSI/BBC USERS' GROUP (AK): Secretary: Ken Harley, 77 Boundary Road, Auckland. Meets third Tuesday, VHF Clubrooms, Hazel Ave, Mt Roskill.
- SYMPOOL (N.Z. SYM user group): John Robertson, PO Box 580, Manurewa, ph 2675-188 (h).
- TARILAND COMPUTER CLUB INC: Meets 4th Wednesday, Remuera Primary School Hall, Dromorne Rd.
- A.Z.T.E.C.: Brian Mayo, Church Street, Katikati. Phone 490-326. Members use all micros.
- BAY MICROCOMPUTER CLUB (Tauranga): G.L. McKenzie, Secretary, Snodgrass Road, Tauranga. Phone: 25-569.
- BAY OF PLENTY TAURANGA COMMODORE USERS GROUP: Contacts - phone 62-083, 65-311, and 83-610. Meets first and third Monday of month, 7 p.m.
- BAY SHARP USERS GROUP: Contact - Phone 86132. Meeting 2nd and 4th Monday. 417 Cameron Road, Tauranga.
- BEACH COMPUTING CLUB (Waihi): Jamie Clarke, Box 132, Waihi (Ph: 45-364 Waihi Beach).
- TAURANGA MAC GROUP: Contact, Clive Bolton, 81-779 (w) 62-811 (h).
- WAIHI COMPUTER ENTHUSIASTS: Contact: G.C. Jenkins, 10 Smith St, Waihi (h) WAH 8478. Workshops every Tuesday. Meetings last Tuesday of month.
- THE ATARI CONNECTION. Contact: Paul Cormack, 29 McDiarmid Cres, Huntly. Ph (h) 88-695.
- HAMILTON SUPER 80 USERS': P.O. Box 16113, Glenview, Hamilton.
- WAIKATO ATARI USERS' CLUB: P.O. Box 6087, Heaphy Terrace, Hamilton. Ph Dave (071) 73-888, Bob (071) 78-434.
- WAIKATO COMMODORE USERS' GROUP: Secretary, Mrs Eileen Woodhouse, 32 Kenny Crescent, Hamilton.
- WAIKATO COMPUTERS IN EDUCATION SOCIETY. Secretary, Geoff Franks, Fraser High School, 72 Elliott Road, Hamilton. Phone (h) 81-050.
- WAIKATO SPECTRUM USERS' GROUP: Secretary: Roger, Loveless, 18 Heath St, Hamilton. Phone 492-080. Meetings: First Tuesday of the month.
- WAIKATO SPECTRAVIDEO USERS' GROUP: P.O. Box 16113, Glenview, Hamilton.
- MORRINSVILLE COMPUTER SOCIETY: Contact: Alison Stonyer, 49 Coronation Road, Morrinsville. Phone 6695 (h). Meets 1st and 3rd Wednesdays.
- GLOWWORM COMPUTER ENTHUSIASTS: Meets every second Sunday of the month in the Otorohanga District Council's board room. Contacts: president, Colin Wilkins, Oto 8331; vice-president, Hugh Button, Oto 7228; secretary, Laurence Bevan, Oto 7066.
- GISBORNE MICROPROCESSOR USERS' GROUP: Stuart Mullett-Merrick, P.O. Box 486, Gisborne, phone 88-828.
- ROTORUA COMPUTER CLUB: Contact: Ken Blackman, 6 Urquhart Place, Rotorua. Third Tuesday of each month at 7pm, Waiariki Community College, Rotorua.
- ELECTRIC APPLE USERS' GROUP: Noel Bridgeman, P.O. Box 3105, Fitzroy, New Plymouth, phone 80-216.
- TARANAKI MICRO COMPUTER SOCIETY: P.O. Box 7003, Bell Block, New Plymouth: Mr K. Smith. Phone 8556, Waitara.
- SOUTH TARANAKI MICROCOMPUTER SOCIETY: Contacts: Apple, Jim Callaghan, 86-667 Hawera; Commodore, Allen Goodhue, 86-194 Hawera; S80, TRS80, John Roberts-Thomson, 84-495 Hawera; Sega, Dave Beale, 85-108 Hawera; Spectrum, Guy Oakly, 8060 Manaia. Sub groups meet on the third Wednesday of the month. The whole society meets periodically in the Hawera High School computer room. Written inquiries to Allen Goodhue, 21 Princes Street, Hawera.
- NAPIER VZ-200 USERS GROUP - Contact: Peter Cox, Ph 435-126 after 4pm or write to Peter Cox, 9 Cranby St, Orepawa, Napier.
- HAWKE'S BAY MICROCOMPUTER USERS' GROUP: Bob Brady, Pirimai Pharmacy, Pirimai Plaza, Napier. Phone 439-016.
- HAWKE'S BAY COMMODORE USER GROUP: Contacts: Mike Phillips, 401 Lascelles Street, Hastings (president); Mark Hodgson, 1108 Oliphant Road, Hastings (secretary). Meetings: first Tuesday of month at H.B. Community College.
- HAWKE'S BAY SPECTRAVIDEO USER GROUP: Meets first Tuesday of month at Hawke's Bay Community College. Contact P. Lawrence, P.O. Box 799, Napier.
- INTERACT USERS GROUP: for more information write to Denis Clark, 43 Charles Street, Westshore, Napier.
- WANGANUI COMMODORE 64 USER GROUP: Contact - P. Northway, Phone (h) 42-916. 7 Broadhead Avenue, Wanganui. Meets first and third Thursdays of month at Wanganui Community College.
- HBCEs (Hawke's Bay Computers in Education Society): Contact - Grant Barnett, 89 King Street, Taradale, Napier. Ph: 446-992.
- MOTOROLA USER GROUP: Harry Wiggins, (ZL2BFR), P.O. Box 1718, Palmerston North. Phone (063) 82-527 (h).
- MANAWATU MICROCOMPUTER CLUB: Contact: Richard Anger, 64-108 (w) or 63-808 (H). Meets twice a month at PDC Social Club rooms.
- HOROWHENUA MICROCOMPUTER CLUB: Meets on second and fourth Thursday of month. President, Wally Withell, P.O. Box 405, Levin; secretary, Dennis Cole, 28 Edinburgh Street, Levin. Ph (069) 83-904.
- WAIRARAPA MICROCOMPUTER USERS' GROUP: Geoffrey Petersen, 27 Cornwall St, Masterton. Ph(h) 87-439.
- CENTRAL DISTRICTS COMPUTERS IN EDUCATION SOCIETY: Rory Butler, 4 John Street, Levin (069) 84-466 or Margaret Morgan, 18 Standen Street, Karori, Wellington. (04) 767-167.
- UPPER HUTT COMPUTER CLUB: Shane Doyle, 18 Holdsworth Avenue, Upper Hutt. Phone 278-545. An all-machine club.
- BBC USER GROUP: Users of other machines welcome too. See entry head of list.
- MICROBEE USERS' CLUB: P.O. Box 871, Wellington, 2nd Sunday of month.
- NEC COMPUTER USERS' GROUP: C/- P.O. Box 3820, Wellington.
- NZ SUPER 80 USERS' GROUP: C/- Peanut Computers, 5 Dundee Pl., Chartwell, Wellington 4, Phone 791-172.
- OHIO USERS' GROUP: Wellington. Secretary/Treasurer: R.N. Hislop, 65B Awatea Street, Porirua.
- POLY USERS GROUP, Wellington: Contact - Christine Greenbank, Computer Studies, Wellington Teachers' College, Private Bag, Karori, Wellington.
- ATARI USERS' GROUP, Wellington: Eddie Nickless. Phone 731-024 (w), P.O. Box 16011. Meetings: first Wednesday of month.
- WELLINGTON APPLE USERS GROUP: Inquiries to secretary, Grant Collison, 58 Lonsdale Cres, Wellington 3. Ph 872-537, evenings. Meets last Saturday of month.
- WELLINGTON COMMODORE USERS' GROUP: P.O. Box 2828, Wellington. Contacts: Peter March (h) 86-701, Robert Keegan (h) 789-157.
- WELLINGTON MICROCOMPUTING SOCIETY INC.: P.O. Box 1581, Wellington, or Bill Parkin (h) 725-086. Meetings are held in the Fellowship Room, St Johns Church, 176 Willis Street, on the 2nd Tuesday each month at 7.30pm.
- WELLINGTON SEGA USER GROUP: Meets first Thursday of month at Papanuigi School Hall. Contact Shaun Parsons, P.O. Box 1871, Wellington. Phone: 897-095 after 6.30 pm.
- SEGA OWNERS CLUB: Lower Hutt. Meets 1st Monday each month. Contact: Murray Trickett. (w) 724-356, (h) 662-747.
- WELLINGTON SPECTRAVIDEO CLUB: Contact - Don Stanley, C/- Box 7057 Wellington South. Ph. 746-906 (w). Meets on one Monday a month at Staff Common Room (Level D), Wellington Clinical School, Mein Street, Newtown.
- WELLINGTON SYSTEM 80 USERS' GROUP: Contact: W.G. (Bill) Lapsley, day 286-175; evenings, 268-939; or Andrew Vincent 780-371 (evenings).
- HUTT VALLEY COMMODORE USER GROUP: Contact - Ken Alexander, C/- 16 Enfield St, Wainuiomata or phone Wainuiomata 645-830. Meetings, first and third Mondays of month at St. Bernard's College, from 7.30 pm.
- NELSON COMMODORE USERS' GROUP: Peter Archer, P.O. Box 860, Nelson, phone (054) 79-362 (h).
- NELSON HOME COMPUTER CLUB: Contact - Mike Jenkins, Box 571, Ph 87-930. Meets, 7 p.m., first and third Tuesdays of the month at Nelson Intermediate.
- BLENHEIM COMPUTER CLUB: Club night second Wednesday of month. Ivan Meynell, Secretary, P.O. Box 668. Phone (h) 85-207 or (w) 87-834.
- MARLBOROUGH COMMODORE USERS GROUP: Secretary, Robin Vercoe, 42 Rogers Street, Blenheim. Meetings: Second Thursday of month, 7.30 p.m., IHC rooms.
- BULLER COMPUTER USERS GROUP: P.O. Box 310, Westport, Phone: 7956 Wpt. R.J. Moroney (secretary).
- HOKITIKA COMPUTER USERS GROUP: Contact - Adrian Mehrens, 185 Sewell Street. Ph: 943.
- CANTERBURY COMPUTER EDUCATION SOCIETY: Contact Graeme Sauer (secretary), P.O. Box 31-065, Ilam, Christchurch 4.
- CHRISTCHURCH APPLE USERS GROUP - Contact: Peter Fitchett, ph 328-189. Meets first Wednesday of month, third floor, Tower Building, Christchurch Teachers' College.
- CHRISTCHURCH ATARI USERS GROUP: Contact Ron van Lindt, 10 Silverdale Place, Christchurch 6. Ph 891-374.
- CHRISTCHURCH SPECTRAVIDEO USERS GROUP - Contact: Lester Reilly, ph (h) 428-686. Meets third Tuesday of month.
- CHRISTCHURCH TRS-80 COLOUR USER GROUP: Meetings: last Wednesday of month. Contact: Dennis Rogers, 21 Frankleigh Street, Christchurch 2. Phone 34-731.
- CHRISTCHURCH '80 USERS' GROUP: Brendan Thompson. Phone (h) 370-381. P.O. 4118, Christchurch.
- OSI USERS' GROUP (CH): Tony Martin, 9 Innes Rd. Phone 555-048.
- SINCLAIR USERS' GROUP CANTERBURY, INC: Contact: Gary Parker (president). Phone 894-820, P.O. Box 4063. Meets 7.30 p.m. last Monday of month. Phone for latest meeting place.
- CHRISTCHURCH COMMODORE USERS GROUP: John Kramer, 885-533 and John Sparrow. Phone 896-099.
- CHRISTCHURCH BBC and ELECTRON USERS GROUP: Meets alternate Monday nights at 6.30 except Saturday or Secondary-School holidays, at Hagley High School. Secretary, Mrs R.D. Nolan, 87 Palmers Road, Christchurch, 9.
- PANASONIC (JB-3000) USERS' GROUP: Contact: Prof B.J. Clarke, Dept of Accountancy, University of Canterbury, Private Bag, Christchurch, 1.
- CHRISTCHURCH COLOUR GENIE USERS' GROUP: Meets 2nd Wednesday, 7.00p.m., Abacus Shop, Shades Arcade. Secretary, Robert Wilson, 17 Warblington Street, Christchurch, 7. Ph: 881-456.
- CHRISTCHURCH SORD MS USERS GROUP: Meets first Thursday of month, 7pm. Ph: 792-771 for details.
- DICK SMITH WIZZARD COMPUTER CLUB, Christchurch: Contact - Tony Dodd, 34 Mayfield Ave. Ph: 557-327.
- CHRISTCHURCH VZ-200 USERS GROUP: Meets second Tuesday of month. Contact Ian Birse, Ph 523-915, Graham Dillon, Ph 324-117, or P.O. Box 22-094, Christchurch 1.
- ASHBURTON COMPUTER SOCIETY: Meets first Monday of month, 7.30 pm. Enquiries to Pete Boyce, 4 Willow St, Ashburton. Ph 83-664.
- SOUTH CANTERBURY COMPUTER GROUP: Caters for all machines from ZX81 to IBM34, Geoff McCaughan. Phone Timaru 84-200 or P.O. Box 73.
- NORTH OTAGO COMPUTER CLUB: Contact: Peter George, P.O. Box 281, Oamaru. Phone 29-106 (h) 70-646 (h).
- LEADING EDGE HOME COMPUTER CLUB: Elaine Orr, Leading Edge Computers, P.O. Box 2260, Dunedin. Phone 55-268 (w).
- OTAGO COMMODORE 64 CLUB: Meets first Tuesday of month, 7.30pm. Contact: Geoff Gray, 41 Eglinton Road. Ph 53-986.
- DUNEDIN SORD USERS' GROUP: Terry Shand. Phone (024) 771-295 (w), 881-432 (h).
- CENTRAL CITY COMPUTER INTEREST GROUP: Contact: Terry Stevens, Box 5260, Dunedin. Phone 882-603. Meetings every second Tuesday.
- OTAGO COMPUTER EDUCATION SOCIETY: Jim Ferguson, Arthur Street School, 26 Arthur Street, Dunedin. Ph. 776-524.
- ATARI USER GROUP, Dunedin: Meets fortnightly on Thursday. Phone Graeme Wheeler 737-907 for the date,

- Acoustic coupler:** Connects the RS232 part of a microcomputer to a telephone handpiece.
- Algorithm:** A list of instructions for carrying out some process step by step.
- Applications program:** A program written to carry out a specific job, for example an accounting or word processing program.
- Array:** A data type found in high level languages, which is stored in a contiguous block of memory. Accessed by the array name and an index making it easier to process groups of data in many situations.
- ASCII:** American Standard Code for Information Interchange. An 8-bit code.
- BASIC:** Beginners' All-purpose Symbolic Instruction Code. The most widely used, and easiest to learn, high level programming language for microcomputers.
- Baud:** Speed of transferring data, measured in bits per second.
- Bidirectional:** A printer that prints when moving left as well as when moving right.
- Binary:** The system of counting in 1's and 0's used by all digital computers. The 1's and 0's are represented in the computer by electrical pulses, either on or off.
- Bit:** Binary digit. Each bit represents a character in a binary number, that is either a 1 or 0. The number 2 equals 10 in binary and is two bits.
- BASIC:** Beginners' All-purpose Symbolic Instruction Code. The most widely used, and easiest to learn, high level programming language for microcomputers.
- Baud:** Speed of transferring data, measured in bits per second.
- Binary:** The system of counting in 1's and 0's used by all digital computers. The 1's and 0's are represented in the computer by electrical pulses, either on or off.
- Bit:** Binary digit. Each bit represents a character in a binary number, that is either a 1 or 0. The number 2 equals 10 in binary and is two bits.
- Block graphics:** Chunky graphics, built up in small blocks rather than fine points.
- Boot:** To load the operating system into the computer from a disk or tape. Usually one of the first steps in preparing the computer for use. Short for bootstrap.
- Buffer:** An area of memory used for temporary storage while transferring data to or from a peripheral such as a printer or a disk drive.
- Bug:** An error in a program.
- Bus:** Also called a trunk or highway - a path on which several parts of a computer system may be connected so that signals can be passed between them.
- Byte:** Eight bits. A letter or number is usually represented in a computer by a series of eight bits called a byte and the computer handles these as one unit or "word".
- CAL:** Computer Aided Learning CAL programs are written to take different actions on different student answers.
- Card:** In hardware, a circuit board.
- CCIT:** An abbreviation for International Telegraph and Telephone Consulting Committee. A standard maker.
- Chip:** An integrated circuit on a single crystal of semiconductor, far smaller than fingernail size.
- CMOS:** Transistor technology - when a pair of transistors of opposite type are used together. Means low power use.
- Computer language:** Any group of letters, numbers, symbols and punctuation marks that enable a user to instruct or communicate with a computer.
- Courseware:** Name for computer programs used in teaching applications.
- cpi:** Means character per inch. A common way of describing character density, i.e., how close together characters are in printers.
- CP/M:** An operating system for Z80 based machines. It is by far the most widely used DOS for Z80 based machines and there is an extremely large software base for it. See also disk operating systems.
- cps:** Characters per second. A common way of describing speed in printers.
- Cursor:** A mark on a video that indicates where the next character will be shown, or where a change can next be made.
- Daisywheel printer:** A printer in which the letters are formed by impact of a letter on a disk rotated until the required character is in position. Daisywheel printing is close to traditional typing in appearance.
- Data:** Any information used by the computer either I/O or internal information. All internal information is represented in binary.
- DC:** Direct coupling (telecomputing); or direct current.
- Disk:** A flat, circular magnetic surface on which the computer can store and retrieve data and programs. A flexible or floppy disk is a single 8 inch or 5 1/4 inch disk of flexible plastic enclosed in an envelope. A hard disk is an assembly of several disks of hard plastic material, mounted one above another on the same spindle. The hard disk holds up to hundreds of millions of bytes - while floppy disks typically hold between 140,000 and three million bytes.
- Disk drive:** The mechanical device which rotates the disk and positions the read/write head so information can be retrieved or sent to the disk by the computer.
- Diskette:** Another name for a 5 1/4 inch floppy disk.
- Disk operating system:** A set of programs that operate and control one or more disk drives. See CP/M for one example. Other examples are TRSDOS (on TRS 80) and DOS 3.3 (for Apples).
- DOS:** See disk operating system.
- Dot matrix:** A type of print head, made up of a matrix of pins, e.g. 8x8. When a character is to be printed the appropriate pins push out and strike the ribbon to paper forming the character.
- Dot graphics:** These graphics are individual screen pixels. Used by either turning on or off one pixel.
- Double-density:** Floppy drives that store twice the standard amount of data in the same space.
- Dump:** Popular term for sending data from a computer to a mass storage device such as disks or tape.
- EPROM:** Erasable, user-programmable, read-only memory.
- Execute:** A command that tells a computer to carry out a user's instructions or program.
- File:** A continuous collection of characters (or bytes) that the user considers a unit (for example on accounts receivable file), stored on a tape or disk for later use.
- Floppies:** Thin plastic disks with a magnetic coating used for storing information. Called floppies because they are flexible.
- FORTH:** A compact language. The programmer extends the language as he programs.
- Friction feed:** A type of paper-feeding system for printers: normal paper in a continuous sheet is gripped between two friction rollers as on a typewriter.
- Hardware:** The computer itself and peripheral machines for storing, reading in and printing out information.
- Hex:** Abbreviation for hexadecimal notation, a base-16 numbering system convenient to use with computers.
- High-level language:** Any English-like language, such as BASIC, that provides easier use for untrained programmers.
- IEEE:** A standardisation based on the Institute of Electrical and Electronics Engineers.
- Ink-jet printer:** These printers form images by spraying droplets of ink on to paper. Each droplet is electrically charged and is deflected into the required position by magnetic plates.
- Input:** Any kind of information that one enters into a computer.
- Interactive:** Refers to the "conversation" or communication between a computer and the operator.
- Interface:** Any hardware/software system that links a microcomputer and any other device.
- I/O "Input/output":**
- Inverse video:** When the background is coloured; e.g. on a black and white screen white becomes background and characters are written in black.
- Justified:** Printing is justified when the lines are flush on the left and right sides.
- K:** The number 1024. Commonly refers to 1024 bytes. Main exception is capacity of individual chips, where K means 1024 bits.
- Kilobyte (or K):** Represents 1024 bytes. For example 5K is 5120 bytes (5 x 1024).
- LCD:** Liquid-crystal display.
- Line feed:** A control code character found in the ASCII character set. Its normal purpose is to move the cursor down one line (on screen) or move paper up one line (on printer). Does not return the cursor to the left-hand margin.
- Lower case:** Non-capital alphabetical letters.
- Machine language:** The binary code language that a computer can directly "understand".
- Mainframe:** The very large computers that banks and other large businesses use are called mainframes. Also in microcomputers the term is sometimes used to describe the core of the machine, i.e. the CPU plus memory.
- Mass storage:** A place in which large amounts of information are stored, such as a cassette tape or floppy disk.
- Megabyte (or Mb):** Represents a million bytes.
- Memory:** The part of the microcomputer that stores information and instructions. Each piece of information or instruction has a unique location assigned to it within a memory.
- Memory capacity:** Amount of available storage space, in Kbytes.
- Menu:** List of options within a program that allows the operator to choose which part to interact with (see Interactive). The options are displayed on a screen and the operator chooses one.
- Microcomputer:** A small computer based on a microprocessor.
- Microprocessor:** The central processing unit or "intelligent" part of a microcomputer. It is contained on a single chip of silicon and controls all the functions and calculations.
- Minicomputer:** Originally a computer that went with a single equipment cabinet. Now a computer between a microcomputer and a mainframe. Note that the boundaries between mini's and the classes on either side of it are unclear.
- Modem:** Modulator-demodulator. An instrument that connects a microcomputer to a telephone and allows it to communicate with another computer over the telephone lines.
- Mother board:** A large circuit board that has other boards attached to it.
- Network:** An interconnected group of computers or terminals linked together for specific communications.
- Output:** The information a computer displays, prints or transmits after it has processed the input. See input and I/O.
- Parallel interface:** A type of communications interface used mostly for printers. It sends a whole character of data down eight (commonly) lines, one bit down each line. The most common type of parallel interface for printers is the Centronics interface.
- Pascal:** A high-level language that may eventually rival BASIC in popularity. It incorporates the form of structured programmes.
- PEEK:** A command that examines a specific memory location and gives the operator the value there.
- Peripherals:** All external input or output devices: printer, terminal, drives etc.
- Pinfeed:** (also called sprocket feed). A method of paper feed in printers using sprockets.
- Pixel:** Picture element. The point on a screen in graphics.
- Plotter:** An output device for translating information from a computer into pictorial or graphical form on paper or a similar medium.
- POKE:** A command that inserts a value into a specific memory location.
- Program:** A set or collection of instructions written in a particular programming language that causes a computer to carry out or execute a given operation.
- RAM:** Random access memory is the very fast memory inside your computer. The access time for any piece is the same. Your program and run-time data are usually stored in RAM.
- REM statement:** A remark statement in BASIC. It serves as a memo to programmers, and plays no part in the running program.
- Resolution:** A measure of the number of points (pixels) on a computer screen.
- ROM:** Read only memory. Any memory in which information or instructions have been permanently fixed.
- Serial interface:** A type of communications interface used for a wide variety of purposes (printers, terminals, telephone correction etc.). It uses a minimum of two wires, and sends the data one bit at a time down one wire. The most common type of serial interface is RS232C.
- Sheet feed:** A type of paper feeding system normally used for high-quality document printers. A special device picks up a sheet of paper and feeds it into friction rollers.
- Software:** Any programs used to operate a computer.
- SP:** Second processor.
- Sprocket feed:** See pin feed.
- System:** A collection of hardware and software where the whole is greater than the sum of the parts.
- Tractor feed:** A type of paper feeding system for printers. Special computer paper with holes along both sides is fed by the tractors gripping these holes.
- Word:** A group of bits that are processed together by the computer. Most microcomputers use eight or 16 bit words.
- WP:** Word processor.

# On the road with MacDrive

By Alex & Fred Wong

The 512K Macintosh has made possible the release of really sophisticated business packages like Jazz, from Lotus Development Corporation. Jazz, which features word processing, database management, spreadsheet calculation, business graphics and communications, is designed exclusively for the 512K Macintosh and Macintosh XL (the ex-Lisa 2/10) computers. Like other serious business packages, it would benefit from the addition of a hard disk drive for mass data storage.

So we feature the Tecmar hard disk system for the Macintosh, named the MacDrive. Tecmar has released a whole range of MacDrives, starting with the 5Mb removable cartridge drive or a 10Mb fixed disk drive. Then there is a combination of two 5Mb removable cartridge drives and finally our review model, the top-of-the-line 10Mb fixed/5Mb removable cartridge drives.

It offers two disk drives, one

holding a 5Mb removable cartridge and the other a 10Mb fixed hard disk for immense, on-line capacity at better speeds with more reliability. With the use of different 5Mb cartridges, which may be likened to floppy disks in use (although not in texture!), MacDrive also provides almost unlimited storage.

### The hardware

The MacDrive comes in a neat, square, Macintosh cream colour metal case which has the same footprint as the Mac and is only half as high, although it's twice as heavy. On the front are two black plastic panels, with the fixed drive behind the top one. The lower panel has a white eject button and a door which lowers to allow removal and insertion of the 5Mb cartridge.

Both panels have a red LED pulse which blinks — short and bright when the drive is reading or writing information, long and bright when the drive is communicating with the computer, and dimly when its idling.

Installation is easy since MacDrive simply plugs into the Mac's serial printer port. The Imagewriter printer (or any other compatible printer) may be connected to the back of the MacDrive so that it will not only work in conjunction with it but will also be provided with a print buffer. This buffer, from the MacDrive's 64K of on-board RAM, is controlled by the MacDrive's 68008 microprocessor (which is downwards compatible with the Mac's 68000), as is the entire operation of the MacDrive.

### Off for a spin

Fred turns on the MacDrive. After about 20 seconds or so, it comes up to speed so Fred turns on the Mac and inserts the MacDrive System Disk Version 2.0. Another quarter-minute later, the MacDrive hard disk icon appears on the desktop and the MacDrive boot-up disk ejects itself. All is well so far.

After booting up, the floppy system disk can be put away, as it will access the hard disk copy of the

HIGH QUALITY

## BINDERS! for BITS & BYTES

We now have available binders to hold your copies of BITS & BYTES. We have opted for the same type of binder used last year (pictured) as these provide high quality protection in an attractive finish.

These are available in two styles.

STYLE 1: With the words "BITS & BYTES, VOL 2, September 1983–August 1984".

(For those who have a complete volume.)

STYLE 2: With the words "BITS & BYTES" only.  
(For recent subscribers or those with a mixture of volumes)

Each Binder holds 11 magazines

**Order now as stocks are limited!!**

**Please use the book club order form in the centre of the magazine and be sure to note which style of wording you require.**

**Cost: \$14.95 per binder**

**\$14.95 EACH**

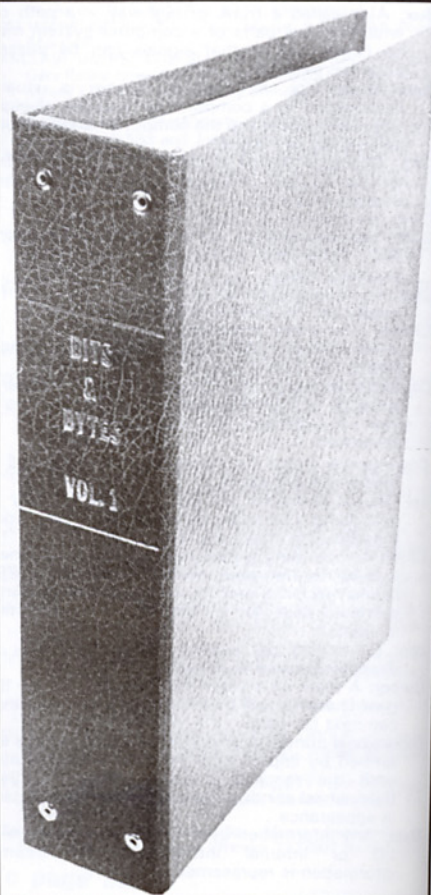



system disk on the MacDrive. That wasn't so hard, was it!

The MacDrive has its own specially modified version of the Finder used to control the drive from the Macintosh. Much like DOS to us oldtimers, this takes care of drive I/O and file maintenance; but unlike the standard Mac Finder, it acknowledges that the MacDrive is on-line. So, when copying applications onto a MacDrive volume, it's highly recommended that the MacDrive System Folder replace the normal one on this volume.

This system has many advantages over the Version 1.0 software. For instance, by using the back-up utility, hard disk files which exceed 400K (a floppy's capacity) may still be copied to floppies for archival purposes. The back-up program will display all the files on the current volume and will specify how many disks will be needed for each one. When copying, the user will be prompted to insert disk no.1, no.2 and so on.

For operation, the MacDrive is divided into separate volumes, which for most purposes can be treated as separate disks. The size of each volume is user specified and 20 different volumes may be created on each hard disk. A volume is created from the pool of free space on the disk and space from any trashed volume will be returned to the pool. With the creation of bigger volumes (1600K or more), Fred is constantly surprised to see huge amounts (1200K) of space available where he was used to seeing 56K or so free on a floppy disk.

Volumes are created, deleted, catalogued and manipulated by a utility on the MacDrive System disk called the Volume Manager (which the old system software didn't have either). It also "mounts" and "unmounts" volumes — a very useful feature because a volume can be accessed only if it is mounted (much like disks can be accessed



*The Tecmar MacDrive*

only if they are inserted). On a 128K Mac, only two MacDrive volumes may be mounted at once while on a Big Mac, four volumes may be mounted.

After the initial power-up ceremony, I go back to my Apple II while Fred drives the Mac wild! Using the Volume Manager, he creates a few volumes each on the fixed and the cartridge drives, and copies files galore over to them (albeit from floppy to hard disk, a bit slowly, I am told). He then copies many of these between the two hard disks — a very quick and painless process.

When he runs MacPaint from the hard disk, he is ecstatic because disk access time is about three times faster than the Mac's floppy. Moving the screen around the picture (which requires disk access) is a breeze.

Speaking of breezes, the whirr from the high quality MacDrive fan is amazingly quiet. The 5Mb cartridge may be ejected or inserted anytime (although it shouldn't be popped in and out like a floppy) and is a great plus for exchanging huge amounts of information or for making backups.

The MacDrive operation overall, is smooth and efficient.

Unfortunately, documentation is the MacDrive's one real foible. The original manual, which is well presented and written, was printed before Version 2.0 of the system disk was released, and is now hopelessly outdated. The installation instructions have changed (previously, the MacDrive was plugged into the Mac's modem port), the operation has changed (the MacDrive was just one big volume before), and the utility program has changed (there weren't any before). A soft eject of the hard disk icon becomes peculiarly risky, too, because the documentation doesn't mention the consequences (which can be dire!)

They don't seem to have printed a new manual yet, and the new material is stored on a little booklet (quite prone to falling apart) tucked in the manual. The new installation instructions are good, and though this addition provides adequate information on the operation of the new software, it is very bare bones about something which is quite paramount to the operation of the MacDrive.

However, a new manual should be out in due course, taking into account Version 2.0 software. Even with the old one, we made no regrettable mistakes.

The MacDrive fulfils its prophecy! It provides huge data and program storage for a Macintosh (big or small) and would be extremely desirable in a business situation. The speed, ease and reliability of operation would make it the number one choice for data storage.

## System summary

|  |   |
|--|---|
| <b>Name:</b>                               | MacDrive.   |
| <b>Manufacturer:</b>                       | Tecmar Inc., Ohio.  |
| <b>Microprocessor:</b>                     | 68008.  |
| <b>Type:</b>                               | 10Mb Winchester hard disk and 5Mb removable cartridge hard disk, \$8792 (review model).             |
| <b>Options:</b>                            | 5Mb removable cartridge, \$324; 10Mb fixed Winchester, \$5527; 5/5 dual removable cartridge \$8792. |
| <b>Reviewers' ratings (5 the highest):</b> | Documentation: 3; ease of use: 5; value for money: 4; support: 5.                                   |

*(Review unit supplied by Southmark Electronics, Auckland).*

# FOUNTAIN *User* NEWS



In this issue:

**Hardware Price Revolution  
The NEW COMMODORES!  
VIC-20 software reviews.**

---

Volume 1 — Issue 3

---

# FOUNTAIN *User* NEWS

**THE REVOLUTION HAS BEGUN and we continue the drive forward with great new prices on COMMODORE hardware! The prices quoted are Recommended Retail only.**

|          |                                    |          |
|----------|------------------------------------|----------|
| VIC-0016 | COMMODORE 16 .....                 | \$395.00 |
| VIC-0064 | COMMODORE 64 .....                 | \$695.00 |
| VIC-0004 | COMMODORE PLUS/4 .....             | \$895.00 |
| VIC-1541 | 1541 DISC DRIVE .....              | \$749.00 |
| VIC-1530 | 1530 DATASETTE .....               | \$ 99.00 |
| VIC-1531 | 1531 DATASETTE .....               | \$ 99.00 |
| VIC-0802 | MPS 802 PRINTER .....              | \$749.00 |
| VIC-0803 | MPS 803 PRINTER .....              | \$549.00 |
| VIC-1701 | 1701 COLOUR MONITOR .....          | \$795.00 |
| VIC-1311 | 1311 JOYSTICK (VIC-20 & C64) ..... | \$ 19.95 |
| VIC-1341 | 1341 JOYSTICK (PLUS/4 & C16) ..... | \$ 29.95 |

**NOW is the time to extend or upgrade your system!!**

*We would like to introduce you to the new members of the COMMODORE family.*

## COMMODORE 16 COMPUTER The Learning Machine — Fun, Games and Brains.



The COMMODORE 16 Home Computer is the ideal computer to introduce everyone to the world of computing.

It has many proven features of the COMMODORE VIC 20 such as

- full Qwerty Keyboard
- 62 Graphics symbols
- ROM cartridge port
- direct connection to a full range of COMMODORE peripherals.

The COMMODORE 16 also has many enhancements such as —

- 16K RAM of which 12K is user accessible for BASIC programming.
- Advanced BASIC (Version 3.5) giving 75 programming instructions including commands for sound, graphics plotting, and program editing.
- Built-in machine code monitor with twelve commands.
- Screen window capability ideal for rough calculations!
- Split screen capability.
- 121 Colours.
- Two joystick ports.
- High resolution graphics (320 x 200 pixels).
- 40 column by 25 row display.
- Four programmed function keys (reprogrammable) for tasks such as loading or saving programs.
- Help key, a marvellous aid when locating errors.
- Four separate cursor keys.

The COMMODORE 16 comes complete with everything you need —

- the COMMODORE 16
- the power supply
- the RF modulator
- the COMMODORE 16 User Guide, a step-by-step friendly instruction book to help you from the time of unpacking to get the most enjoyment from your new computer.
- and of course built-in are all the features previously

mentioned.

The COMMODORE 16 is used with the COMMODORE 1531 datasette and the COMMODORE 1311 joystick. These have ports which are common only to the COMMODORE 16 and the COMMODORE PLUS/4. All other peripherals such as the 1541 disc drive, and the MPS 802 printer are compatible with the COMMODORE 16.

Most COMMODORE 16 software is compatible with the COMMODORE PLUS/4.

## COMMODORE PLUS/4 COMPUTER The Applications Machine

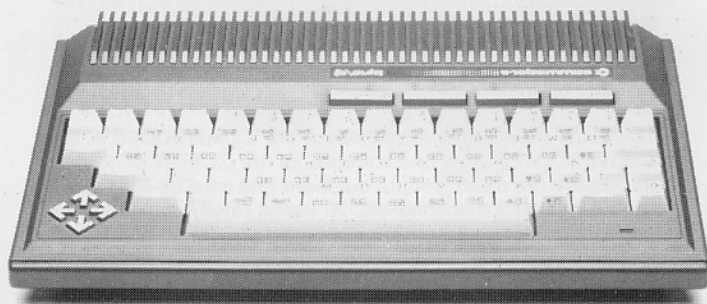

The COMMODORE PLUS/4 is the first home computer designed especially for productivity applications. Of course, it is also able to be used for all the other things that home computers are used for, such as games and education.

The COMMODORE PLUS/4 has software for the four most popular tasks built-in —

- word processor
- spreadsheet (for calculations etc)
- file management (database)
- business graphics (for charts & graphs)

Not only is this built-in software a boon to the small business user, it has many applications in the home.

These functions are all interactive i.e. figures from the spreadsheet can easily be incorporated in a letter and can also then be turned into an easy to understand graph, all of which can then be stored in the database.

The COMMODORE PLUS/4 is a handsomely-styled machine that has many features which make it ideally suited to its target market —

- 64K RAM of which 60K is user accessible in BASIC.
- Advanced BASIC (Version 3.5) giving 75 programming

instructions including commands such as DLOAD, DIR, and commands for sound, graphics plotting, and program editing.

- Built-in Machine code monitor with twelve commands.
- Screen windows capability for rough calculations!
- Split screen capability.
- Four separate cursor keys.
- Help Key, a marvellous aid when locating errors.
- Two joystick ports.
- High resolution graphics (320 x 200 pixels).
- 121 colours.
- Warm reset button.
- Eight programmed function keys (reprogrammable) for tasks such as loading or saving programs.
- Parallel User Port.
- Full QWERTY Keyboard.
- 62 graphics symbols.
- ROM cartridge port.
- 7501 processor.

The COMMODORE PLUS/4 comes complete with everything you need —

- The COMMODORE PLUS/4.
- the power supply.
- the RF modulator.
- the COMMODORE PLUS/4 Integrated Software Manual, which documents in easy-to-learn tutorial fashion not only the "how-to" of the built-in software but also the "why".
- the COMMODORE PLUS/4 User Guide, a friendly, step-by-step instruction book to help you from the time of unpacking through to getting the most from the built-in software.
- and of course built-in are all the features previously mentioned.

The COMMODORE PLUS/4 is used with the COMMODORE 1531 datasette and the COMMODORE 1341 joystick. These have ports which are common only to the COMMODORE 16 and the COMMODORE PLUS/4. All other peripherals such as the 1541 disc drive, and the MPS printers are compatible with the COMMODORE PLUS/4.

The COMMODORE PLUS/4 is not a replacement for the COMMODORE 64, it is an "applications" machine.

There has been a lot of talk about the COMMODORE 16, the COMMODORE PLUS/4 and software for the COMMODORE 64. I think there are many people out there that must be feeling left out! Our several thousand VIC-20 users!! Finally something for you!

## COMMODORE VIC-20 COMPUTER

For those that are interested in learning to program their COMMODORE VIC-20 there is available INTRODUCTION TO BASIC FOR THE VIC-20 PARTS 1 & 2. This is a comprehensive teach yourself programming series which also teaches you the full capabilities of the VIC-20. This course includes a self-study text divided into 15 or 17 different 'units' each covering an important part of programming. Also included are two cassette tapes with programs designed to aid in understanding the art of programming in BASIC. This course also deals with the designing of program flowcharts to help you write correct, efficient and useful programs.

|          |                              |         |             |
|----------|------------------------------|---------|-------------|
| VIC-0101 | INTRODUCTION TO BASIC PART 1 | \$45.00 | Rec Retail. |
| VIC-0102 | INTRODUCTION TO BASIC PART 2 | \$45.00 | Rec Retail. |

## PROGRAMMER'S AID CARTRIDGE

Once you are writing your own programs you will appreciate the help of the PROGRAMMER'S AID CARTRIDGE.

This has been designed to help both new and experienced BASIC programmers to write, edit and debug programs quickly

and easily. This is achieved by the AID commands which are automatically incorporated into the VIC operating system when the cartridge is inserted. The cartridge also assigns some of the AID commands and some BASIC keywords to the function keys thus giving the programmer his own short-cuts during program writing. There is also a facility for the programmer to assign his own functions to these keys.



The PROGRAMMER'S AID Manual is divided into three parts: —

— Introduction to PROGRAMMER'S AID, outlining the program in broad terms. It also explains how to load and start PROGRAMMERS AID, and the conventions used in describing the format of each PROGRAMMER'S AID command.

— The Commands of PROGRAMMER'S AID, states the format of each command, explains its purpose and uses, and an example is shown.

— Using PROGRAMMER'S AID as a Tool, illustrates the speed and efficiency of using PROGRAMMER'S AID when programming in VIC BASIC. This section also demonstrates how some of the cartridge's attributes are used to write, edit and debug a simple program.

The PROGRAMMERS AID CARTRIDGE does not attempt to teach BASIC programming on the VIC, but helps immensely with the task of writing your programs. To learn BASIC programming Introduction to BASIC Parts 1 and 2 provide a full course.

As you can see the PROGRAMMING AID CARTRIDGE is an invaluable programming accessory.

## TURTLE GRAPHICS

An exciting and fun way to discover computer programming concepts is TURTLE GRAPHICS. Designed for people from six to ninety-six, this is an easy-to-learn computer language that enables the beginning programmer to master the computer in just a few minutes.

By telling an imaginary turtle how to roam about on the VIC-20'S screen, the Turtle Graphics programmer can create colourful and artistic pictures. As you become more and more practiced at teaching the turtle to paint using the VIC-20'S rich graphics and colour palette, you are painlessly learning all of the basics of computer programming. This not only develops computer awareness, but enriches one's math, logic, communication and artistic skills as well.

TURTLE GRAPHICS is based on work pioneered by Seymour Papert of the MIT during more than a decade of research into how people should be taught about computers. TURTLE GRAPHICS has most of the key features of Papert's LOGO language, but at a fraction of the cost. It also makes the maximum use of the VIC-20'S colour and graphics capabilities, many of which are superior to even the most expensive LOGO system.

TURTLE GRAPHICS is menu-driven for ease of use and has a well-written, easy-to-follow manual with many examples included.

TURTLE GRAPHICS is simple to learn and easy to use. A marvellous way to introduce the family to computing!!

|         |                 |          |             |
|---------|-----------------|----------|-------------|
| VHE-026 | TURTLE GRAPHICS | \$129.00 | Rec Retail. |
|---------|-----------------|----------|-------------|

## THE VIC-EDUCATION SERIES

One of the most rewarding uses of the COMMODORE VIC-20 is in the field of education. The VIC-EDUCATION philosophy is —

\* All children want to learn and love to learn — provided they are not exposed to stress, boredom and frustration.

\* This is where the VIC 20 comes in. It's fun to use, it's patient and waits for every child to have the chance of succeeding with any problem in his or her own time and pace ... and it teaches every time in the same way.

\* The pressure and tension of arcade games is avoided, but each program develops its own interest with graphics and sound.

\* The first objective is to encourage calmness to help concentration and stretch attention spans. Nothing is more encouraging than the sweet smell of success and the computer provides rewards for work done — and makes it all fun!!



To provide all these things FOUNTAIN MARKETING has in its catalogue many education programs. We have eleven separate titles covering maths for all levels of attainment from teaching the recognition of numbers through to playing the computer at guessing games. The language series of eight titles is designed to help expand word knowledge, give an awareness of spelling habits and to develop GOOD spelling habits. The success of this series is based on the relationship between seeing words and correct spelling ... and there are exciting incentives to complete each program successfully!

These are sold separately at \$12.95 Rec. Retail or can also be obtained in packs at a slightly more economical price.

Also available in this series are:

VIC-1881 VIC MUSIC \$35.95 Rec. Retail.

Vic Music provides an introduction to musical notation, using a combination of sound and graphics. It introduces the user to bass and treble clefs, and individually covers natural, sharp and flat scales. The notes are named, their position on the staff illustrated and their sound demonstrated. There is the option of using a quiz format, which is valuable for revision. It is suitable both as a beginner's course or a refresher course for more experienced musicians, for all ages from 8 up. Contains three cassettes.

VIC-1882 HISTORY \$47.95 Rec. Retail.

Suitable for children aged from 10 upwards, this history pack gives a broad overview of each topic. Covering subjects from early man to the middle ages, and from early Greece to the rise and decline of the Roman Empire, each quiz is preceded with

a detailed tutorial carefully explaining the period in question. Used in conjunction with the Geography 1 pack, this series provides an excellent introduction to the social sciences. Contains four cassettes.

VIC-1883 GEOGRAPHY \$35.95 Rec. Retail.

Geography 1 details such topics as oceans and landmarks, rivers and world continents. Introduced in an easy-to-follow and comprehensive fashion, these quizzes cover the subject of geography in detail. For children 10 and upwards. Contains three cassettes.

VIC-1884 PRESCHOOLER \$35.95 Rec. Retail.

Pre-schooler gently introduces children to picture/word association, with careful use of graphics and sound. It is fun to use, and patient too!! This five program series uses a novel approach, giving the option of either word/picture learning or quizzes on picture recognition. Suitable for children aged 4 to 8 years old. Contains three cassettes.

\* \* \* \* \*  
**And for those times after the work is done!**

\* **MOLE ATTACK.** A fun, colourful "cartoon action" game that is bound to improve your co-ordination! You are trying to keep those nasty moles underground where they belong, but they keep popping up! To do this you must bop those nasty moles when they stick their heads out of their burrows! The lower the mole is when you bop it, the higher your score will be! But watch out for their tails! The actions gets faster as time runs out. How many can you clunk before time runs out?? Fast, fun and frantic!!

Available on cartridge VIC-1912 \$39.95

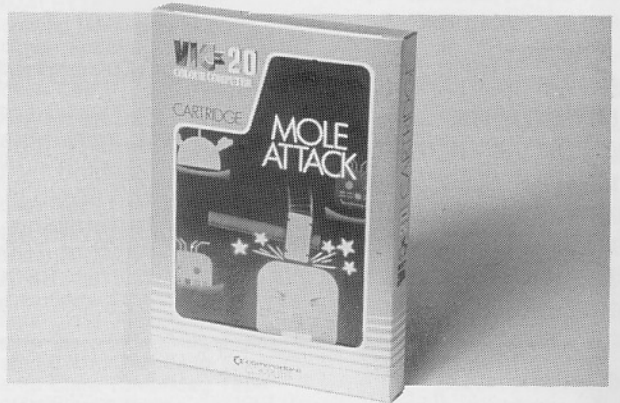

\* **RAT RACE.** You are a mouse caught in a maze trying to eat ten cheeses scattered throughout before the chasing rats catch you! To help you there is a radar screen showing your location! Can you win this challenging game of action, strategy and reflexes? Watch out for the Black Cats! Keep your eyes peeled and reactions sharpened!!

Available on cartridge VIC-1910 \$49.95

\* **ALIEN ATTACK.** You are under attack by an immense force of aliens! You must destroy the eight waves of aliens before they pass. When the Mother Ship arrives you must destroy the green aliens inside the landing spacecraft! The final wave, if you can get there, is based on your skill in navigating through the asteroid storm and dodging through the meteors to freedom! The meteors are immune to your lasers!! Can you survive in Deep Space!!

Available on cassette VIC-1811 \$19.95

This is a newsletter from us to you. We hope you enjoy reading it and find it useful. If there is anything that you would like covered in FOUNTAIN USER NEWS, just drop us a line. That's all for this issue, so ...

=====**Until Next Time, Good Health and Good Computing!**=====

JENNI TURNER  
Fountain Marketing Limited  
P O Box 5029  
AUCKLAND

# MICRO NEWS

## Maths blaster

A maths training program for young children aged six to 11 years has been released for the C64.

Math Blaster contains 600 problems and students are guided through the learning stages, having fun along the way.

## COMMODORE 64

```

1236 GETA$:IFA$=""THEN1236
1237 IFA$(">") THEN1236
1240 FORI=1TO1000:NEXT:CR=5:PRINT"(CLR)"
1250 POKEV,100:POKEV+1,175
1260 POKEV+2,50 :POKEV+3,10
1270 POKEV+4,80 :POKEV+5,20
1280 POKEV+6,70 :POKEV+7,30
1290 POKEV+8,150:POKEV+9,40
1300 POKEV+10,120:POKEV+11,100
1310 POKEV+12,90 :POKEV+13,230
1320 POKEV+14,90 :POKEV+15,130
1330 POKEV+44,15:POKEV+40,15
1340 FORI=1TO24:PRINT"
      █:NEXT
1350 PRINT"(HOME){C/DN}{C/DN}{C/DN}{C/DN}{C/DN}"
      TAB(27)"HIGH"
1360 PRINT"(HOME){C/DN}{C/DN}{C/DN}{C/DN}{C/DN}"
      TAB(27)"SCORE:";HS$
1370 PRINT"(HOME){C/DN}{C/DN}{C/DN}{C/DN}{C/DN}"
      TAB(27)"CARS :";CR
1499 RETURN
    
```

It takes a two-pronged approach in teaching maths skills. The first stage helps memorising of basic facts and operations with graphic screen presentations requiring the student to fill in answers; the second stage is aimed at increasing speed, accuracy and confidence in handling the basics through an arcade-style game.

Questions are presented and the correct answer has to be indicated by making an animated character run along to the correct position. The character is then loaded into a cannon and blasted into the answer box.

The user can choose the subject including subtraction, multiplication, division, fractions, decimals and percentages, as well as choose from four or five different skill levels.

The program comes with two disks and is menu-driven. The recommended retail price is \$159.

## Versatile tape drive

The new Kennedy Model 9400 tri-density tape drive, released in New Zealand by Datamatic, can store up to 180Mb in a GCR format, while still maintaining compatibility in PE and NRZI at 1600 and 800bpi.

The 9400, which costs about \$25,000, has built-in data buffering.

## Advertiser index

|                              |                |                          |        |
|------------------------------|----------------|--------------------------|--------|
| AMP Insurance                | 24             | Harris Electronics       | 75     |
| AVM Electronics              | 58             | Hi-tec Micro             | B/C    |
| AWA                          | 45             |                          |        |
| Auckland University Bookshop | 83             | ISIS                     | 65     |
|                              |                | James Electronics        | 68     |
| Barson Computers             | 5              | Kane Agencies            | 73     |
| Bits & Bytes                 | 2, 86          | MCP Applications         | I/B    |
| Business Electronics         | 52             | MEC                      | 51     |
| Business World               | 59             | S.D. Mandeno             | 48     |
|                              |                | Manukau Computers        | 23     |
| C.A. Design                  | 53             | Micro Software Hire Club | 64     |
| Commodore Computers          | 19             | Micropac                 | 81     |
| Computer Game Rentals        | 48             | Microsource              | 50     |
| Computer South               | 28             | Molymerx                 | 62, 64 |
| Computer Store               | 63             |                          |        |
| Computer Works               | 80             | New Zealand Post Office  | 29     |
| Computers for People         | 56, 72, 81     |                          |        |
| Comworth Systems             | 54             | Otakou Software          | 80     |
| Concord Communications       | 38             |                          |        |
|                              |                | PC '85                   | 21     |
| David Reid Electronics       | 79             | PC Power                 | 49     |
| Delairco Electronics         | 56             | Paul Smith               | 31     |
| Dick Smith Electronics       | 7              | Pitman Publishing        | 83     |
|                              |                |                          |        |
| Einstein Scientific          | 25             | Roulston Green           | 82     |
|                              |                | Sandfly Software         | 38, 78 |
| Fountain Marketing           | 88, 89, 90, 91 | Silkwood Manufacturing   | 60     |
|                              |                | Sirius Systems           | 57     |
| GTS Engineering              | 31             | Software Supplies        | 78     |
| Genesis Systems              | 17             |                          |        |
| E.C. Gough                   | 31             |                          |        |
| Grandstand Leisure           | I/F, 1         |                          |        |
| Grundman Electronics         | 67             |                          |        |

# USER GROUPS

- time and place of next meeting, or write to 38 Calder Avenue, North East Valley, Dunedin.
- SPECTRUM AND QL COMPUTER CLUB** — Contact: James Palmer, 37 Sunbury St, Dunedin. Phone, 44-787, Monday to Friday after 4pm.
- SOUTHLAND MICRO USERS GROUP** (Invercargill) — Contact: R.J. Edgeler, ph 56-052, P.O. Box 612, Invercargill. Meets every second Tuesday.
- SOUTHLAND COMMODORE USER GROUP**: (VIC 20 and 64s). Address: C/- Office Equipment Southland, Box 1079, Invercargill.
- SOUTHLAND COMPUTER EDUCATION SOCIETY**: Secretary, Bob Evans, Southland Boys' High School, Herbert Street, Invercargill. Ph (h), 73-050 or ZL4LX.
- GORE COMPUTER CLUB**: Meets first and thirs Tuesdays of month, 7pm. Contacts: Allan Rodgers, ph 7488, Dave Clarke, ph 5836.
- N.Z. SOFTWARE EXCHANGE ASSOCIATION**: Non-profit group for exchange of software written by programmer members. Contact: Ian Thain, Box 333, Tokoroa.
- Note**: Clubs would appreciate a stamped self-addressed envelope with any written inquiry to them.

If your club or group is not listed, drop a line with the details to: Club Contacts, *BITS & BYTES*, Box 827, Christchurch. The deadline for additions and alterations is the first weekend of the month before the next issue.

# CLASSIFIEDS

**WANTED: RS232C Interface** (Cat X-4022) for Dick Smith System 80 S-100 Expansion Unit (Cat X-4020). C. Jenks, 135 Rawhiti Rd, Pukerua Bay, Wellington, Ph 399696.

**COMPUTER, Radio & Electronic swap meet**, biggest in North Island. Sat 11th May, Cambridge Town Hall, 10am. Tables \$7. Full details from Sec. Cambridge Radio Club, C/- 185 Victoria St, Cambridge. Ph (A/H) (Std 07127) 4654.

**SPEECH SYNTHESISERS** microcomputers e.g. BBC, C64, Spectrum etc. Specify type when ordering. Write: The Voice, P.O. Box 2518, Christchurch for details. Enclose s.a.e.

**PRINTER/PLOTTER** — C/64. Perfect condition. New pens and paper. \$150. Light pen and software \$50. Ph Wellsford 7239.

**APPLE USERS**: Join Apple Juice, the New Zealand tabloid for Apple owners. Write to P. McKenzie, 4/464 Parnell Road, Parnell, Auckland, 1.

**PERIPHERALS**: Quality printers, drives, drive cases & monitors at warehouse prices brand new & guaranteed SAE to COMSEC, P.O. Box 30, Waihi Beach South.

**TRS-80/SYSTEM 80**: users interested in joining a public domain for business who require programs, or can supply please write (s.a.e.) to Box 30, Waihi Beach South.

**SANYO MBC 1000: 8 bit CPM. Twin 360K drives. Built in parallel printer interface. Complete with Wordstar, Calcstar, DBase II!!!! \$3250 complete! Write 49 Wayside Ave, Christchurch, 5 or phone Christchurch 582-513**

**BETA BASIC 1.8** as reviewed in November issue of Bits & Bytes 48K Spectrum now available. \$35.00 & \$1.50 p & p. Westbridge Computers, P.O. Box 7280, Christchurch.

|                         |        |
|-------------------------|--------|
| Southmark               | 15     |
| Spacific Software       | 47     |
| Sperry Computers        | 41     |
| Supatech Electronics    | 34, 35 |
| Total Computer Services | 30     |
| Verbatim                | 27     |
| Warburton Franki        | 39     |
| Xidex                   | 59     |

# IBM — PC

## WHY PAY MORE

### COMPARE OUR PRICES

## SOFTWARE

|                                 |             |
|---------------------------------|-------------|
| Symphony                        | \$1,732.00  |
| Lotus 1-2-3                     | \$1,234.00  |
| Sideways                        | \$ 102.00   |
| Managing your Business 1-2-3    | \$ 192.00   |
| Analyse the Slate 1-2-2         | \$ 192.00   |
| Making Business Decisions 1-2-3 | \$ 192.00   |
| FRIDAY                          | \$ 525.00   |
| d Base II                       | \$2,150.00  |
| d Base III                      | \$1,610.00  |
| FRAMEWORK                       | \$ 1,295.00 |
| KnowledgeMan                    | \$ 995.00   |
| Open Access                     | \$ 1,175.00 |
| Quick Code                      | \$ 572.00   |
| Crosstalk                       | \$ 423.00   |
| REVELATION                      | \$ 1,600.00 |
| Condor 3                        | \$ 1,165.00 |
| B.P.S. Graphics                 | \$ 535.00   |
| Peter Norton Utilities          | \$ 215.00   |
| WORDSTAR                        | \$ 610.00   |
| Mailmerge                       | \$ 365.00   |
| Spellstar                       | \$ 365.00   |
| MultiMate                       | \$1,227.00  |
| MultiMate Training              | \$ 220.00   |
| P.F.S. File                     | \$ 342.00   |
| P.F.S. Report                   | \$ 308.00   |
| P.F.S. Graph                    | \$ 348.00   |
| P.F.S. Write                    | \$ 348.00   |
| P.F.S. Proof                    | \$ 240.00   |
| P.F.S. Access                   | \$ 215.00   |
| T/Maker 3                       | CALL        |
| SPSS/PC Statistics              | CALL        |
| Microsoft Word                  | \$ 735.00   |
| Microsoft Chart                 | \$ 550.00   |
| Microsoft Project               | \$ 550.00   |

## HARDWARE

## EXPANSION CARDS

|   |             |
|---|-------------|
| Blossom Multifunction Expansion Card                                      | \$ 816.00   |
| AST 6 pak Plus Multifunction Expansion                                    | \$ 852.00   |
| Short Memory Card   | CALL        |
| J-RAM-2 Multifunction Megamemory<br>supports 740K DOS/ carries 2Mb R.A.M. | \$ 1,260.00 |
| 64K Memory Upgrades   | \$ 130.00   |
| 8087 Co Processor   | \$ 466.00   |
| 80 287 Co Processor (AT)  | CALL        |

## COMMUNICATIONS

|                        |             |
|------------------------|-------------|
| 5251 LOCAL             | \$ 1,880.00 |
| 5251 Remote            | \$ 2,483.00 |
| AST S.N.A.             | \$ 2,287.00 |
| PCOX                   | CALL        |
| IRMA                   | \$ 2,467.00 |
| IRMALINE               | CALL        |
| IRMALETTE              | CALL        |
| Comway Mono-graphics   | \$ 803.00   |
| Colman Adapter         | \$ 171.00   |
| Mono/Colour Combo Card | \$ 1,485.00 |
| Colour Card            | \$ 745.00   |
| Short Colour Card      | \$ 662.00   |

## KEYBOARDS

|                       |           |
|-----------------------|-----------|
| Microsoft Mouse       | \$ 370.00 |
| Numeric Short Key Pad | CALL      |
| Speed key             | \$ 310.00 |

## DISK DRIVES/BACKUP

|                           |              |
|---------------------------|--------------|
| Tandon Disk Drive 360K    | \$ 625.00    |
| Santa Clara 18Mb/6        | \$ 7,310.00  |
| Santa Clara 38Mb/6        | \$ 11,135.00 |
| Santa Clara 36Mb/6        | \$11,032.00  |
| Santa Clara 32Mb/Mag Tape | \$11,032.00  |
| Santa Clara 57Mb/Mag Tape | \$15,102.00  |
| Santa Clara 73Mb/Mag Tape | \$17,102.00  |
| 10Mb Internal Drive       | \$ 3,250.00  |
| Magnetic Tape — 45Mb      | \$ 138.00    |
| Magnetic Tape — 60Mb      | \$ 160.00    |

## NETWORKING

|                                 |             |
|---------------------------------|-------------|
| Santa Clara PC Terminal 256K    | \$ 4,265.00 |
| Diskless Boot Prom              | \$ 260.00   |
| PC-Net Starter Kit              | \$ 2,943.00 |
| Additional Stations             | \$ 1,352.00 |
| Novell Netware Operating System | \$ 2,925.00 |
| IBM PC. XT. AT.                 | CALL        |

**Corporate, Dealer, and Government  
Enquiries Welcome**

## SPECIAL OFFER THIS MONTH ONLY

|   |         |
|---|---------|
| Symphony plus Graphics Card                         | \$ 2535 |
| Lotus 1-2-3 plus Graphics Card                      | \$ 2045 |
| d Base II Database plus<br>Multimate Word Processor | \$ 1800 |

Prices: Subject to Change  
Terms: Nett Cash 7 days from  
receipt of goods

Delivery  
Costs: Extra

MC-P Applications  
First Floor  
10 O'Connell Street  
AUCKLAND

P.O. Box 5056  
Wellesley Street  
AUCKLAND  
Telephone: (09) 34-545

# ACCUTRACK FLEXIBLE DISKS

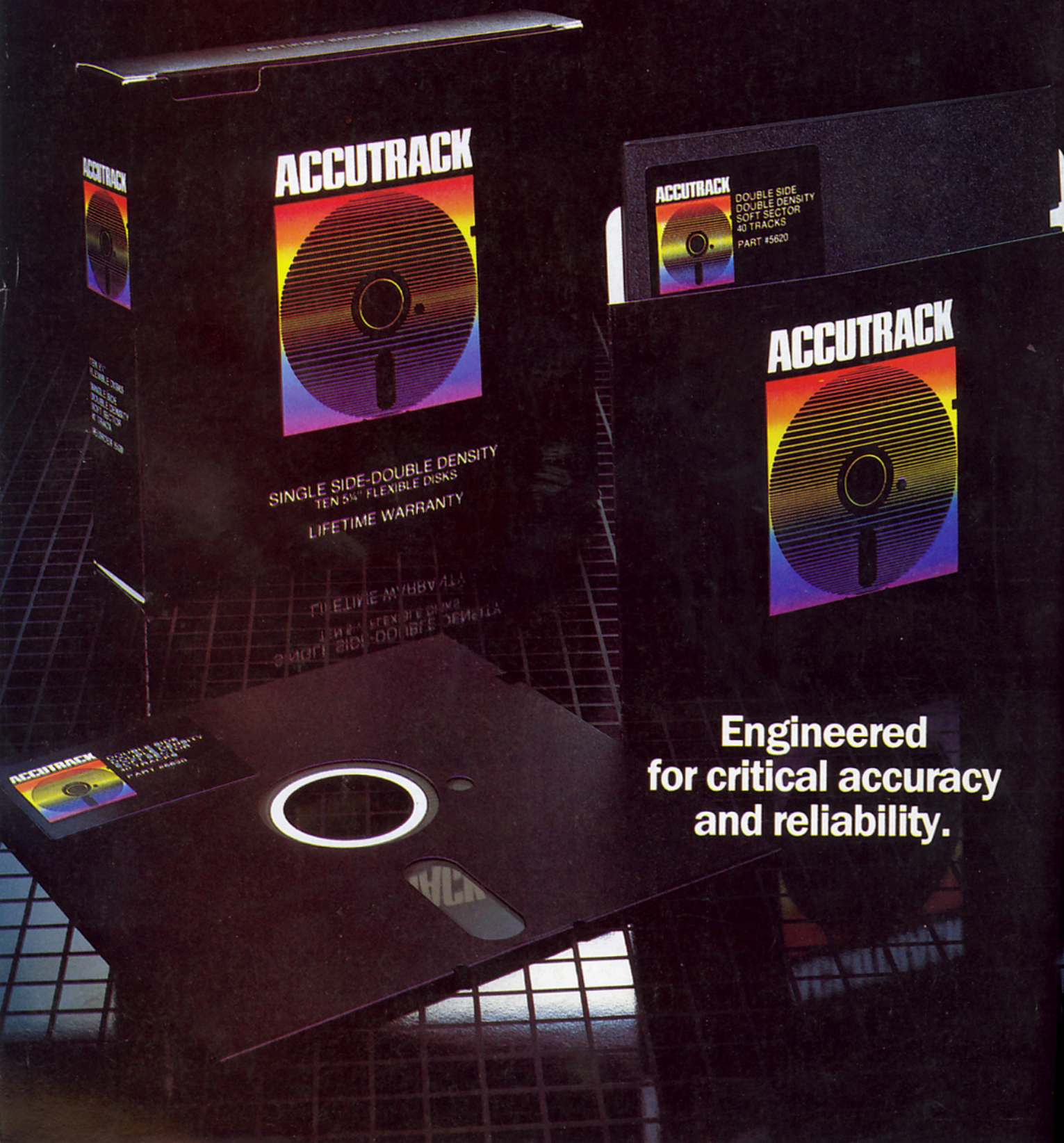

**ACCUTRACK**



SINGLE SIDE-DOUBLE DENSITY  
TEN 5 1/4" FLEXIBLE DISKS  
LIFETIME WARRANTY

**ACCUTRACK**

DOUBLE SIDE  
DOUBLE DENSITY  
SOFT SECTOR  
40 TRACKS  
PART #5620

**ACCUTRACK**

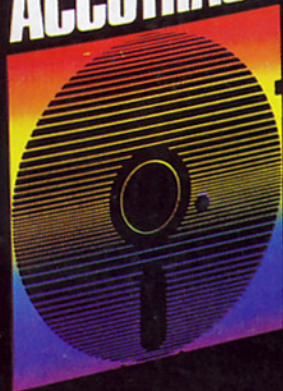

**Engineered  
for critical accuracy  
and reliability.**

Dennison

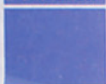

Available at leading computer outlets  
throughout New Zealand.  
Made in the U.S.A. with a lifetime warranty.